



# Controloil®

CATÁLOGO DE PRODUTOS



Segurança no  
controle de movimentos

## Líder no mercado de reposição de componentes para freios hidráulicos

A Controil é uma empresa Frax-Te e está localizada no estado do Rio Grande do Sul - Brasil. Possui certificação da ISO 9001 e ISO TS 16949 em suas unidades de negócio: freios e polímeros além de contar com um portfólio de fluidos e filtros.

Com máquinas modernas e engenharia qualificada, agrega o melhor da tecnologia, produzindo componentes para o sistema de freios hidráulicos e soluções em polímeros, ambos produtos destinados ao setor automotivo.

A Controil conta com um portfólio com mais de 850 itens e atende aos mercados nacional e internacional, exportando para países da América do Sul, Central, Europa e Ásia. Além disso, possui um centro tecnológico próprio que garante a qualidade de seus produtos.

## Peças Controil em um Veículo

### Sistema de Freio Hidráulico

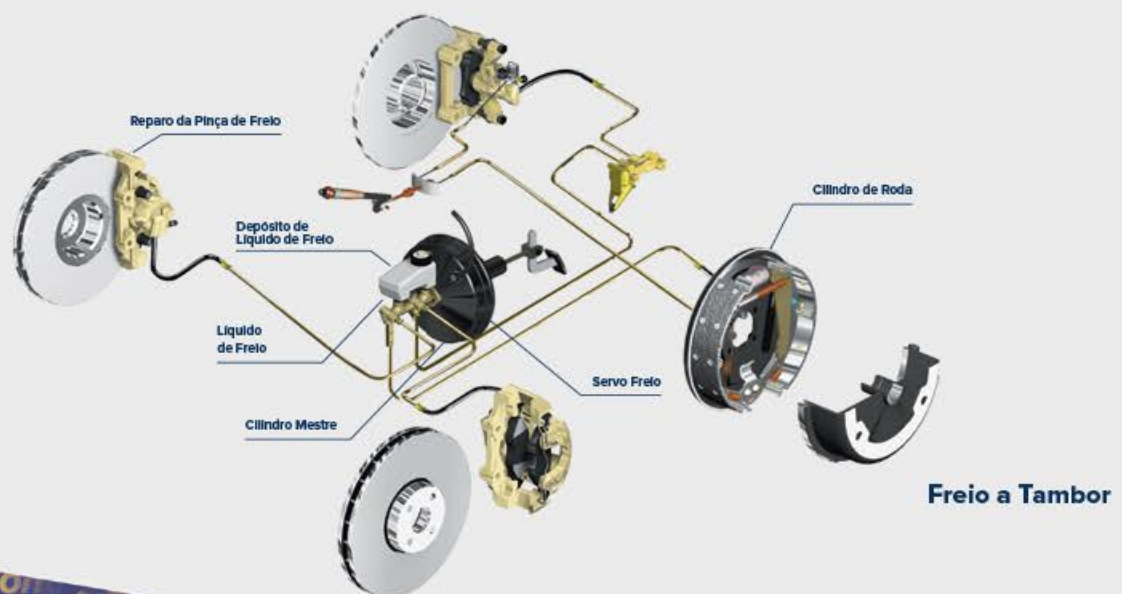

## TABELA DE CONVERSÃO

04

## POLÍMEROS

28

## BUSCA POR VEÍCULOS

34

## Marca/Modelo

AGRALE	35	IVECO	173
ALFA ROMEO	42	JAGUAR	173
ASIA	44	KIA	173
AUDI	44	MAZDA	175
BMW	45	MERCEDEZ-BENZ	175
CHRYSLER	46	MERCEDEZ-BENZ CAMINHÕES	177
CHRYSLER – CAMINHÕES	46	MITSUBISHI	192
CITROËN	46	NISSAN	194
CROSS LANDER	51	PEUGEOT	195
DAEWOO	51	PUMA	203
DODGE	51	PUMA – CAMINHÕES	204
FIAT	52	RENAULT	204
FIAT ALLIS	83	SCANIA – CAMINHÕES	210
FIAT – CAMINHÕES	83	SEAT	210
FORD	84	SUZUKI	213
FORD CAMINHÕES	110	TOYOTA	213
GM – CHEVROLET	117	TROLLER	217
GM CAMINHÕES	158	VOLKSWAGEN	219
GMC	163	VOLKSWAGEN – CAMINHÕES	246
GURGEL	164	VOLVO	255
HONDA	168	VOLVO – CAMINHÕES	255
HYUNDAI	170		

## BUSCA POR PEÇAS

257

RESERVATÓRIO DE LÍQUIDO DE FREIO	258	ATUADOR CONCÊNTRICO DE EMBREAGEM	305
REPARO	261	CILINDRO DE RODA	307
CILINDRO MESTRE	290	SERVO FREIO	320
CILINDRO MESTRE DE EMBREAGEM	298		



CONTROIL	ATE	TEVES - EUROPE	TRW - VARGA	TRW - LUCAS	BOSCH	FIAT	FORD	GM	VW	TOYOTA
C-0100	-	-	-	-	RM 8851	-	-	94622166	-	-
C-0101	-	-	RCRS00112	-	-	-	-	93229987	-	-
C-0102	5441	-	RCRS00317	-	-	-	84NU2K478A	-	3056113014	-
"	5854	-	RCRS00449	-	-	-	BD7M2K478A	-	3056113015	-
"	-	-	RCRS23058	-	-	-	-	-	305611301A	-
"	-	-	-	-	-	-	-	-	305611301B	-
"	-	-	-	-	-	-	-	-	377611301	-
"	-	-	-	-	-	-	-	-	377611301B	-
C-0103	-	-	RCRS00341	-	-	-	-	52250461	-	-
"	-	-	RRRS00011	-	-	-	-	94626036	-	-
C-0104	5424	-	-	-	-	-	-	94656140	-	-
"	5802	-	-	-	-	-	-	-	-	-
C-0105	-	-	-	-	-	-	-	93228764	-	-
"	-	-	-	-	-	-	-	94648551	-	-
C-0106	5648	-	RCRS00500	-	-	-	-	93235562	-	-
"	5705	-	-	-	-	-	-	93281899	-	-
"	5827	-	-	-	-	-	-	93289337	-	-
C-0107	-	-	RCRS00040	-	-	-	3256113014	-	3256113014	-
"	-	-	-	-	-	-	3256113015	-	3256113015	-
"	-	-	-	-	-	-	ZBC611301	-	ZBC611301	-
C-0108	5440	-	RCRS00530	-	-	-	-	-	ZBA611301	-
"	5852	-	RCRS23708	-	-	-	-	-	-	-
C-0109	-	-	-	-	-	-	-	94652806	-	-
C-0111	-	-	-	-	-	-	88TU2K478BA	-	-	-
"	-	-	-	-	-	-	BF5T2K478A	-	-	-
C-1002	-	-	-	-	-	-	-	52258578	-	-
C-1003	-	-	RRCD51772	-	RM 4961	-	-	94625936	-	-
C-1004	-	-	RRCM50636	-	-	-	-	7362933	-	-
C-1008	-	-	RRCD00353	-	-	-	-	94625963	-	-
C-1011	-	-	RRCM50865	-	RM 4442	-	BD5T2004A	-	-	-
C-1012	-	-	-	-	RM 4152	-	542698181	-	542698181	-
"	-	-	-	-	-	-	81AB2B507BA	-	-	-
C-1013	-	-	RRCM51225	-	RM 4004	-	81278	-	-	-
C-1015	-	-	-	-	-	-	-	-	T00698211	-
C-1017	-	-	RRCD00213	-	-	-	-	94626024	-	-
C-1019	-	-	RRCD00221	-	-	-	BE2P2004A	-	-	-
"	-	-	RRCD00430	-	-	-	-	-	-	-
C-1020	-	-	RRCD00310	-	-	-	-	-	-	47210-98001
C-1021	-	-	RRCD00401	-	RM 4301	-	-	-	2116981555	-
C-1023	-	-	RRCM00150	-	-	-	-	-	T06698211	-
C-1027	-	-	RRCD00450	-	RM 4035	-	3056981813	-	3056981813	-
"	-	-	RRCD00507	-	-	-	-	-	305698181B	-
C-1028	-	-	RRCD00440	-	-	7074072	-	-	-	-
"	-	-	RRCD00485	-	-	-	-	-	-	-
C-1029	5422	-	-	-	-	-	-	94656143	-	-
"	5800	-	-	-	-	-	-	-	-	-
C-1030	-	-	-	-	RM 4242	-	-	52273086	-	-
C-1031	-	-	-	-	RM 4174	-	-	94652668	-	-
C-1034	-	-	-	-	RM 4185	-	88TU2004BA	-	-	-
C-1035	-	-	RRCM50563	-	-	-	-	-	111698183	-
C-1039	-	-	RRCM00132	-	-	-	-	-	-	-
C-1040	-	-	RRCM51241	-	-	7122846	-	-	-	-
C-1045	-	-	RRCM50679	-	-	-	-	-	-	-

Servo Freio	Cilindro de Roda – Linha Leve	Reparos de Hydrovac
Cilindro Mestre	Reparos de Cilindro Mestre	Válvula de Retenção de Vácuo
Cilindro de Embreagem	Reparos de Cilindro de Embreagem	Reservatórios de Líquido de Freio
Cilindro de Roda – Linha Pesada	Reparos de Cilindro de Roda Mangueira do Filtro de Ar	Atuadores Concêntricos de Embreagem



CONTROIL	ATE	TEVES - EUROPE	TRW - VARGA	TRW - LUCAS	BOSCH	FIAT	FORD	GM	VW	TOYOTA
C-1047	-	-	RRCD00167	-	-	-	BD8M2004A	-	-	-
C-1048	5141	-	RRCM50806	-	-	-	-	-	111698173A	-
C-1049	-	-	RRCM50741	-	-	-	-	-	211698201	-
C-1050	-	-	-	-	-	-	-	94652478	-	-
C-1051	-	-	RRCM51268	-	-	-	-	7318728	-	-
C-1053	-	-	RRCM50131	-	-	-	BD9C2004A	-	-	-
C-1054	-	-	RRCM50857	-	-	-	BC2Y2004A	-	-	-
C-1055	-	-	RRCD51497	-	-	-	ZBF698181	-	ZBF698181	-
C-1059	-	-	RRCM50458	-	-	-	-	-	-	-
C-1060	5145	-	RRCD00078	-	RM 4202	-	-	-	1056981551	-
"	5148	-	RRCD00108	-	-	-	-	-	1136981551	-
"	-	-	-	-	-	-	-	-	3016981551	-
C-1061	5143	-	RRCM60946	-	-	-	-	-	1136981554	-
C-1062	-	-	RRCM50891	-	-	-	85190	-	-	-
"	-	-	-	-	-	-	BD2M2004A	-	-	-
C-1067	-	-	RRCM51446	-	RM 4409	-	-	7319482	-	-
C-1070	-	-	RRCM00175	-	-	-	-	-	-	-
"	-	-	RRCM51128	-	-	-	-	-	-	-
C-1077	-	-	RRCD50717	-	RM 4080	-	-	-	-	-
C-1078	-	-	RRCD50921	-	-	-	-	-	-	-
C-1079	-	-	RRCM00078	-	-	-	-	-	2116981552	-
"	-	-	RRCM51470	-	-	-	-	-	-	-
C-1082	-	-	-	-	RM 4359	-	-	7319471	-	-
C-1085	-	-	RRCD00019	-	-	-	-	8306806	-	-
C-1090	-	-	-	-	-	-	-	94604488	-	-
C-1092	-	-	-	-	RM 4224	-	BE5C2004A	94604154	-	-
C-1093	-	-	-	-	-	-	BD6C2004B	-	-	-
C-1094	-	-	-	-	-	-	BD7D2004A	-	-	-
C-1098	5147	-	-	-	RM 4154	7073020	-	-	-	-
"	5748	-	-	-	-	-	-	-	-	-
C-1099	-	-	RRCR00191	-	-	-	BD7M2004A	-	-	-
C-1101	-	-	-	-	RM 4446	-	BD5Y2004B	-	-	-
C-1103	-	-	-	-	-	-	BD5C2004B	-	-	-
C-1104	-	-	RRCM00035	-	-	-	-	-	-	-
"	-	-	RRCM51136	-	-	-	-	-	-	-
C-1109	-	-	RRCD51519	-	RM 4046	-	-	52250460	-	-
C-1110	5469	-	-	-	-	7074620	-	-	-	-
"	5767	-	-	-	-	-	-	-	-	-
C-1111	5487	-	-	-	-	-	-	-	-	-
C-1112	5488	-	-	-	-	-	-	-	-	-
C-1113	5489	-	-	-	-	-	-	-	-	-
C-1114	-	-	-	-	RM 4056	-	-	52252737	-	-
C-1116	5256	-	-	-	-	-	-	-	305698181A	-
"	5850	-	-	-	-	-	-	-	-	-
C-1117	-	-	-	-	RM 4070	-	-	-	-	-
C-1118	-	-	-	-	RM 4081	7075923	-	-	-	-
C-1119	-	-	-	-	RM 9401	7077699	-	-	-	-
C-1120	-	-	-	-	RM 4060	7075449	-	-	-	-
C-1122	-	-	-	-	-	-	-	90272657	-	-
C-1123	-	-	-	-	-	-	-	90297550	-	-
C-1124	-	-	-	-	-	-	-	90297552	-	-
C-1125	-	-	-	-	RM 4124	-	BF2C2004A	93215632	-	-
C-1127	-	-	RRCD51837	-	-	-	547698181	-	547698181	-

Servo Freio	Cilindro de Roda – Linha Leve	Reparos de Hydrovac
Cilindro Mestre	Reparos de Cilindro Mestre	Válvula de Retenção de Vácuo
Cilindro de Embreagem	Reparos de Cilindro de Embreagem	Reservatórios de Líquido de Freio
Cilindro de Roda – Linha Pesada	Reparos de Cilindro de Roda Mangueira do Filtro de Ar	Atuadores Concêntricos de Embreagem

CONTROIL	ATE	TEVES - EUROPE	TRW - VARGA	TRW - LUCAS	BOSCH	FIAT	FORD	GM	VW	TOYOTA
C-1128	-	-	-	-	RM 4146	-	547698181A	-	547698181A	-
C-1129	-	-	-	-	-	-	-	3492436	-	-
"	-	-	-	-	-	-	-	3495611	-	-
C-1132	5646	-	-	-	-	7078628	-	93239406	-	-
"	5826	-	-	-	-	-	-	-	-	-
C-1133	-	-	-	-	RM 4168	-	-	93234210	-	-
C-1134	-	-	RRCD51888	-	-	-	-	93229985	-	-
C-1137	-	-	RRCD00590	-	-	-	3256981811	-	3256981811	-
C-1138	-	-	-	-	-	-	94FB2B507AA	-	-	-
"	-	-	-	-	-	-	94FB2B507AB	-	-	-
C-1140	-	-	-	-	-	-	-	90297380	-	-
C-1141	-	-	-	-	-	-	-	3492355	-	-
C-1142	-	-	-	-	RM 4171	7077700	-	-	-	-
C-1143	-	-	-	-	RM 4172	-	-	-	373698181	-
C-1144	-	-	-	-	RM 4187	-	3256981812	-	3256981812	-
C-1145	-	-	RRCD00680	-	-	-	96FB2B507BC	-	-	-
C-1146	-	-	RRCD00690	-	-	-	96FB2B507CC	-	-	-
"	-	-	-	-	-	-	97FU2B507BA	-	-	-
C-1150	-	-	RRCD00700	-	-	-	97KB2B507AA	-	-	-
"	-	-	-	-	-	-	97KU2B507AA	-	-	-
C-1152	5696	-	-	-	-	7078824	-	-	-	-
"	5786	-	-	-	-	-	-	-	-	-
C-1155	-	-	RRCD00720	-	-	-	-	-	-	-
C-1157	-	-	RRCD00270	-	-	-	BF6T2004AA	-	-	-
C-1160	-	-	-	-	-	-	-	90369757	-	-
C-1161	5955	-	-	-	-	-	-	93289469	-	-
"	5992	-	-	-	-	-	-	-	-	-
C-1164	-	-	-	-	-	-	-	RE001206	-	-
C-1169	-	-	-	-	RM 4201	-	-	-	-	-
C-1170	-	-	RRCD00710	-	-	-	-	93285152	-	-
C-1171	-	-	-	-	-	-	-	93364009	-	-
C-1173	-	-	RRCD00280	-	-	-	-	-	-	-
C-1201	-	-	-	-	RS 4962	-	BE0T2309A	94613370	T11698015A	-
C-1209	-	-	-	-	RS 4158	-	BE3Y2309A	-	-	-
C-1213	-	-	-	-	RT 4594	7122821	BD6T2309A	9307680	-	-
C-1401	-	-	-	-	RR 4909	-	-	94613405	T11698705	-
C-1402	-	-	-	-	RR 4912	-	-	94613315	-	-
C-1404	-	-	RRFD00877	-	-	-	-	-	102698471	-
C-1405	-	-	-	-	RR 4138	-	BE5Y2128A	93215637	-	-
"	-	-	-	-	RR 4209	-	-	93233873	-	-
C-1407	-	-	RRCR55495	-	RR 4215	-	BE5C2128A	93260026	-	-
"	-	-	-	-	RR 4221	-	-	94604240	-	-
C-1408	-	-	RRCR55282	-	-	-	BD5C2221B	-	-	-
C-1412	-	-	RRCR55290	-	RR 4379	-	BD5Y2221B	94648608	-	-
C-1413	-	-	RRFD01040	-	-	-	84HU2L484A	94626005	-	-
"	-	-	RRFD01130	-	-	-	-	-	-	-
C-1415	5304	-	RRCR57692	-	RR 4145	-	-	94626131	-	-
C-1416	-	-	RRCR00050	-	RR 4044	-	2S4698705	7363274	-	-
"	-	-	RRCR56866	-	RR 4222	-	-	-	-	-
C-1417	-	-	RRCR00496	-	-	-	-	-	-	47590-98001
C-1418	-	-	RRCR00501	-	-	-	-	-	-	47610-98001
C-1419	5418	-	-	-	-	7075910	542698277	93290888	379698471	-
"	5545	-	-	-	-	-	81AB2B107AA	93388175	542698277	-

Servo Freio	Cilindro de Roda – Linha Leve	Reparos de Hydrovac
Cilindro Mestre	Reparos de Cilindro Mestre	Válvula de Retenção de Vácuo
Cilindro de Embreagem	Reparos de Cilindro de Embreagem	Reservatórios de Líquido de Freio
Cilindro de Roda – Linha Pesada	Reparos de Cilindro de Roda Mangueira do Filtro de Ar	Atuadores Concêntricos de Embreagem

CONTROL	ATE	TEVES - EUROPE	TRW - VARGA	TRW - LUCAS	BOSCH	FIAT	FORD	GM	VW	TOYOTA
C-1420	5774	-	RRCR57749	-	RR 4155	-	542698341	-	542698341	-
"	-	-	-	-	-	-	71BB2128CA	-	-	-
"	-	-	-	-	-	-	88AR2128A	-	-	-
C-1421	-	-	-	-	RD 4342	7074169	BD1M2221B	-	-	-
C-1422	-	-	RRCR55665	-	RR 2143	-	BD4Y2221A	7362915	-	-
"	-	-	-	-	RR 4032	-	BF8T2128A	-	-	-
C-1423	-	-	RRCR55657	-	-	-	-	7363275	-	-
C-1424	-	-	-	-	RR 4973	7073732	-	-	-	-
C-1427	5369	-	RRCR00080	-	-	7074024	-	-	-	-
"	5745	-	RRCR57722	-	-	-	-	-	-	-
C-1430	5265	-	-	-	-	-	-	-	2116984712	-
"	5899	-	-	-	-	-	-	-	-	-
C-1432	-	-	-	-	-	-	-	-	T11698701	-
C-1433	-	-	RRCR57811	-	RR 4143	-	-	-	T06698705	-
C-1434	5170	-	-	-	-	7073026	BE1M2W302A	-	-	-
"	5357	-	-	-	-	-	-	-	-	-
"	5736	-	-	-	-	-	-	-	-	-
C-1435	-	-	-	-	-	-	BD5B2221A	-	-	-
C-1438	-	-	-	-	-	-	BD5B2128A	-	-	-
C-1439	5527	-	RRCR00135	-	RR 4205	-	BD8N2221A	94613666	-	-
"	-	-	RRCR57196	-	-	-	-	-	-	-
C-1441	-	-	-	-	RR 4921	-	BE0M2221A	-	-	-
C-1442	-	-	-	-	RR 54195	-	BD8M2221D	94622234	-	-
C-1443	5363	-	-	-	-	7074026	84FB2B107AA	-	171698471B	-
"	5754	-	-	-	-	-	ZBC698471A	-	ZBC698471A	-
C-1445	5268	-	RRCR00674	-	-	-	-	-	-	-
"	5904	-	-	-	-	-	-	-	-	-
C-1446	5267	-	RRCR00030	-	RR 4121	-	3096983412	-	3096983412	-
"	5842	-	RRCR00526	-	-	-	-	-	-	-
C-1447	-	-	RRCR57188	-	-	-	-	-	3086982411	-
"	-	-	RRCR57910	-	-	-	-	-	-	-
C-1449	-	-	RRFD01780	-	-	-	-	-	-	04479-35010
C-1452	-	-	-	-	-	-	-	18029813	-	-
C-1453	-	-	RRCR56424	-	-	-	-	-	-	-
C-1454	-	-	RRCR56432	-	-	-	-	-	-	-
C-1464	5139	-	RRCR56556	-	-	-	-	-	-	-
C-1472	-	-	RRCR56386	-	-	-	-	-	113698293	-
C-1473	5136	-	RRCR56394	-	RR 64157	-	-	-	1136982932	-
"	-	-	RRCR56580	-	-	-	-	-	-	-
"	-	-	RRCR56661	-	-	-	-	-	-	-
C-1475	5133	-	RRCR56599	-	RR 4152	-	-	-	-	-
C-1476	-	-	RRCR56221	-	-	-	-	-	2116982916	-
"	-	-	RRCR56912	-	-	-	-	-	-	-
C-1477	-	-	RRCR56440	-	-	-	-	-	2316984111	-
C-1478	5140	-	RRCR56564	-	-	-	-	-	-	-
C-1479	-	-	-	-	RD 4342	-	BD1M2221B	-	-	-
C-1480	-	-	RRFD54020	-	-	-	-	7329000	-	-
C-1481	5525	-	RRCR00040	-	RR 4204	-	547698341A	7329084	547698341A	-
"	5796	-	RRCR00453	-	-	-	96FB2128BA	-	-	-
"	-	-	RRCR56671	-	-	-	BEDM2221B	-	-	-
"	-	-	RRCR57870	-	-	-	-	-	-	-
C-1485	-	-	-	-	RR 4439	7121671	BD9T2221A	9300399	-	-
C-1486	-	-	RRCR56467	-	-	-	-	-	-	47511-98001

Servo Freio	Cilindro de Roda – Linha Leve	Reparos de Hydrovac
Cilindro Mestre	Reparos de Cilindro Mestre	Válvula de Retenção de Vácuo
Cilindro de Embreagem	Reparos de Cilindro de Embreagem	Reservatórios de Líquido de Freio
Cilindro de Roda – Linha Pesada	Reparos de Cilindro de Roda Mangueira do Filtro de Ar	Atuadores Concêntricos de Embreagem



CONTROIL	ATE	TEVES - EUROPE	TRW - VARGA	TRW - LUCAS	BOSCH	FIAT	FORD	GM	VW	TOYOTA
C-1487	-	-	RRCR56084	-	-	-	-	7326215	-	-
C-1488	-	-	RRCR56807	-	RR 4213	-	-	-	-	-
C-1489	-	-	RRCR56920	-	-	-	BD5M2221A	-	-	-
"	-	-	-	-	-	-	BE5M2221A	-	-	-
C-1490	5165	-	-	-	-	-	-	7329716	-	-
"	5456	-	-	-	-	-	-	9307614	-	-
C-1492	5791	-	-	-	RR 4964	-	-	94622245	-	-
C-1493	5169	-	-	-	-	-	-	-	ZBA698471A	-
"	5833	-	-	-	-	-	-	-	-	-
C-1494	5266	-	RRCR00259	-	RR 4119	-	171698341B	-	171698341B	-
"	-	-	-	-	-	-	-	-	ZBA698341A	-
C-1495	-	-	RRCR57080	-	-	-	-	-	2116982913	-
C-1496	5137	-	RRCR56750	-	RR 4158	-	-	-	113698602	-
C-1498	5162	-	-	-	-	127903700	-	-	1056984711	-
"	-	-	-	-	-	-	-	-	1136984711	-
C-1499	-	-	-	-	-	-	-	9307616	-	-
C-1500	-	-	-	-	RR 4745	-	BE0C2128B	94604144	-	-
C-1501	5166	-	-	-	-	127903600	BD1A2W302A	94613283	-	-
C-1503	-	-	-	-	-	-	BD5D2BM5A	-	-	-
C-1506	5164	-	-	-	-	-	-	-	3016984711	-
C-1509	-	-	RRCR00143	-	-	-	BD8M2221C	-	-	-
C-1510	-	-	-	-	RR 4164	-	BD8M2221B	-	-	-
"	-	-	-	-	RR 4706	-	BE4P2221A	-	-	-
C-1515	-	-	RRCR00240	-	-	-	-	94604390	-	-
C-1520	-	-	RRCR00216	-	-	7119504	BD5Y2221N	-	-	-
C-1521	5429	-	-	-	-	-	-	94652435	-	-
C-1522	-	-	RRCR57226	-	RR 4214	-	-	-	-	-
C-1524	5454	-	RRCR00070	-	-	-	-	52252517	-	-
"	5822	-	RRCR57706	-	-	-	-	-	-	-
C-1525	-	-	RRFD00729	-	-	-	-	52250462	-	-
C-1526	-	-	RRFD00443	-	-	-	-	-	-	-
C-1527	5455	-	RRCR57765	-	-	-	-	52252575	-	-
C-1528	-	-	RRFD00321	-	-	-	85HU2K021E	-	-	-
C-1529	-	-	RRCR57234	-	-	-	-	-	-	-
C-1530	-	-	SJ1142	-	-	-	-	-	-	-
C-1531	-	-	-	-	RR 4053	-	-	52258427	-	-
C-1532	-	-	RRFD00745	-	-	7074031	-	-	-	-
"	-	-	RRFD01170	-	-	792551	-	-	-	-
C-1534	5689	-	-	-	RR 4079	7075918	-	-	-	-
"	5781	-	-	-	-	-	-	-	-	-
C-1535	-	-	RRFD00801	-	-	-	-	93201716	-	-
C-1536	-	-	-	-	RR 4055	-	-	52258428	-	-
C-1537	-	-	RRFD00893	-	-	9941668	-	93209326	-	-
"	-	-	-	-	-	9947820	-	-	-	-
C-1538	-	-	RRFD01008	-	-	-	-	90359389	-	-
C-1539	5586	-	-	-	-	-	-	90295004	-	-
C-1541	5585	-	-	-	-	-	-	90295005	-	-
C-1542	-	-	-	-	RD 4128	-	2SF698295	93215607	-	-
C-1543	-	-	RRCR57897	-	RR 64195	-	-	-	-	-
C-1545	5621	-	-	-	-	-	547698277A	-	547698471B	-
"	-	-	-	-	-	-	547698471B	-	-	-
"	-	-	-	-	-	-	89BB2B107AA	-	-	-
C-1546	5627	-	-	-	-	-	547698277	-	547698277	-

Servo Freio	Cilindro de Roda – Linha Leve	Reparos de Hydrovac
Cilindro Mestre	Reparos de Cilindro Mestre	Válvula de Retenção de Vácuo
Cilindro de Embreagem	Reparos de Cilindro de Embreagem	Reservatórios de Líquido de Freio
Cilindro de Roda – Linha Pesada	Reparos de Cilindro de Roda Mangueira do Filtro de Ar	Atuadores Concêntricos de Embreagem

CONTROL	ATE	TEVES - EUROPE	TRW - VARGA	TRW - LUCAS	BOSCH	FIAT	FORD	GM	VW	TOYOTA
C-1547	-	-	RRFD00360	-	-	-	-	93236570	-	-
C-1549	-	-	RRFD00270	-	-	9942016	-	-	-	-
C-1550	5652	-	-	-	-	-	-	90421731	-	-
"	5806	-	-	-	-	-	-	93229719	-	-
C-1552	-	-	RRFD01060	-	-	-	-	-	-	-
C-1553	-	-	RRFD01080	-	-	-	-	-	-	-
C-1554	-	-	-	-	RR 4163	-	547698341B	-	547698341B	-
C-1556	5801	-	-	-	-	-	-	-	-	-
C-1558	-	-	-	-	-	9946021	-	-	431698471B	-
"	-	-	-	-	-	9950507	-	-	-	-
C-1559	-	-	RRFD01230	-	-	-	-	93289746	377698471	-
"	-	-	-	-	-	-	-	93326277	-	-
C-1565	5661	-	-	-	-	-	-	90297767	-	-
C-1566	-	-	RRCR00890	-	-	-	96FB2128AA	-	-	-
C-1567	6137	-	-	-	-	-	-	90540169	4A0698471	-
C-1568	-	-	RRFD01220	-	-	-	377698473A	-	377698471A	-
"	-	-	RRFD01710	-	-	-	-	-	377698473A	-
C-1570	-	-	-	-	-	-	-	-	-	04474-35080
C-1575	-	-	-	-	-	-	547698473	-	547698473	-
C-1578	-	-	RRCR00900	-	-	-	93BB2128AA	-	-	-
C-1579	-	-	-	-	-	-	-	RE000021	-	-
"	-	-	-	-	-	-	-	RE003085	-	-
C-1581	-	-	RRCR00560	-	-	-	-	-	-	-
C-1582	-	-	-	-	-	-	93BB2128CA	-	-	-
C-1587	6132	-	-	-	-	-	-	-	1J0698471	-
"	-	-	-	-	-	-	-	-	3A0698471	-
C-1592	-	-	-	-	RD 4283	-	BF7T2A128A	-	-	-
"	-	-	-	-	-	-	F57Z2120A	-	-	-
C-1597	-	-	-	-	-	9945940	-	-	-	-
C-1598	-	-	RRFD01800	-	-	-	-	-	7X0698471	-
C-1599	-	-	-	-	-	-	F81Z2120AA	-	-	-
C-1603	-	-	RRCE51254	-	-	-	-	-	-	31420-98001
C-1604	-	-	RRCE55012	-	-	-	-	-	-	31460-98001
C-1610	-	-	RRCE00031	-	-	7117151	-	-	-	-
"	-	-	RRCE00129	-	-	-	-	-	-	-
C-1611	-	-	RRCE00137	-	-	-	-	-	-	-
C-1612	-	-	RRCE00099	-	-	-	-	-	T00798133	-
C-1613	-	-	RRCE00102	-	-	-	-	-	T11798131	-
C-1614	-	-	RRCE00072	-	-	-	-	-	-	-
C-1615	-	-	RRCE00234	-	-	-	-	-	-	-
C-1616	-	-	RRCE00242	-	-	-	-	-	-	-
C-1617	-	-	RRCE00021	-	-	-	-	-	-	-
C-1618	-	-	RRCE00013	-	-	-	-	-	-	-
C-1621	-	-	RRCE00153	-	-	-	-	-	-	-
C-1623	-	-	RRCE00048	-	-	-	85HU7578A	-	-	-
"	-	-	RRCE00390	-	-	-	-	-	-	-
C-1624	-	-	RRCE00358	-	-	-	-	-	-	-
C-1625	-	-	RRCE00366	-	-	-	-	-	-	-
C-1626	-	-	RRCE00080	-	-	-	-	-	-	-
C-1627	-	-	RRCE00171	-	-	-	-	-	-	-
C-1628	-	-	RRCE00315	-	-	-	-	-	-	-
C-1629	-	-	RRCE00323	-	-	-	-	-	-	-
C-1630	-	-	RRCE00064	-	-	-	85HU7560A	-	2RP798131A	-

Servo Freio	Cilindro de Roda – Linha Leve	Reparos de Hydrovac
Cilindro Mestre	Reparos de Cilindro Mestre	Válvula de Retenção de Vácuo
Cilindro de Embreagem	Reparos de Cilindro de Embreagem	Reservatórios de Líquido de Freio
Cilindro de Roda – Linha Pesada	Reparos de Cilindro de Roda Mangueira do Filtro de Ar	Atuadores Concêntricos de Embreagem

CONTROIL	ATE	TEVES - EUROPE	TRW - VARGA	TRW - LUCAS	BOSCH	FIAT	FORD	GM	VW	TOYOTA
"	-	-	-	-	-	-	TJG798131	-	TAP798131	-
"	-	-	-	-	-	-	-	-	TJG798131	-
C-1631	-	-	RRCE00218	-	-	-	-	-	TF3798133	-
C-1632	-	-	RRCE00161	-	-	-	-	-	TE3798131	-
C-1634	-	-	-	-	RM 4111	-	-	-	-	-
C-1635	-	-	RRCE00440	-	-	-	-	-	-	-
C-1636	-	-	RRCE00260	-	-	-	-	-	-	-
C-1637	-	-	RRCE00270	-	-	-	-	-	-	-
C-1640	-	-	RRCE00420	-	-	-	-	-	-	-
C-1645	-	-	RRCE00430	-	-	-	-	-	-	-
C-1750	-	-	SRVA59014	-	-	-	-	-	3312612151	-
"	-	-	SRVA59138	-	-	-	-	-	-	-
C-1753	5425	-	RRVA00080	-	RS 4161	4382055	3256984851	-	3076984851	-
"	-	-	RRVA00128	-	-	-	ZBC698485A	-	3256984851	-
"	-	-	RRVA00136	-	-	-	-	-	ZBA698485A	-
"	-	-	-	-	-	-	-	-	ZBC698485A	-
C-1755	5510	-	-	-	RT 4415	7073650	88TU2A154AA	52252741	-	-
"	-	-	-	-	-	7074628	-	93231258	-	-
"	-	-	-	-	-	7077022	-	94604141	-	-
"	-	-	-	-	-	7642566	-	94656217	-	-
"	-	-	RRFD01150	-	-	-	-	-	-	-
C-2000	5434	-	RCCD00680	-	CM 1940S	-	-	-	30561101510	-
"	5849	-	-	-	CM 2930	-	-	-	30561101513	-
"	-	-	-	-	CM 9169	-	-	-	3056110157	-
"	-	-	-	-	-	-	-	-	305611015A	-
C-2001	6034	-	-	-	CM 9931	-	-	94622159	-	-
C-2002	6331	-	RCCD00700	-	-	-	84NU2140A	-	-	-
"	-	-	-	-	-	-	84PU2140A	-	-	-
C-2003	5109	0331171408.3	RCCM23314	PMC104	-	-	-	-	1136110211	-
"	-	-	-	-	-	-	-	-	113611021F	-
"	-	-	-	-	-	-	-	-	113611021G	-
"	-	-	-	-	-	-	-	-	113611023	-
"	-	-	-	-	-	-	-	-	113611023B	-
C-2005	5110	-	RCCM23799	-	-	-	-	-	1136110213	-
C-2006	5114	-	RCCD00210	PMD220	CM 9164	4347257	-	-	-	-
"	5747	-	RCCD28251	-	-	4447257	-	-	-	-
C-2007	5111	-	RCCD24061	-	CM 9179	5950290	-	-	1136110156	-
"	5117	-	RCCD24116	-	-	-	-	-	1496110152	-
"	-	-	-	-	-	-	-	-	3016110154	-
C-2008	6025	2421221711.3	-	PMH166	CM 1262	-	542611015	-	542611015	-
"	-	-	-	-	-	-	6081237	-	-	-
"	-	-	-	-	-	-	6081238	-	-	-
"	-	-	-	-	-	-	81AB2140BB	-	-	-
"	-	-	-	-	-	-	81AB2140CB	-	-	-
"	-	-	-	-	-	-	88AR2140A	-	-	-
C-2009	5343	0321201491.3	RCCD00543	PMF125	CM 9412	-	-	-	171611019	-
"	5344	0321201492.3	RCCD00710	-	-	-	-	-	171611019A	-
"	-	-	-	-	-	-	-	-	171611019C	-
"	-	-	-	-	-	-	-	-	171611019E	-
"	-	-	-	-	-	-	-	-	171611019H	-
"	-	-	-	-	-	-	-	-	171611019N	-
"	-	-	-	-	-	-	-	-	172611019A	-
"	-	-	-	-	-	-	-	-	3056110154	-

Servo Freio	Cilindro de Roda – Linha Leve	Reparos de Hydrovac
Cilindro Mestre	Reparos de Cilindro Mestre	Válvula de Retenção de Vácuo
Cilindro de Embreagem	Reparos de Cilindro de Embreagem	Reservatórios de Líquido de Freio
Cilindro de Roda – Linha Pesada	Reparos de Cilindro de Roda Mangueira do Filtro de Ar	Atuadores Concêntricos de Embreagem



CONTROIL	ATE	TEVES - EUROPE	TRW - VARGA	TRW - LUCAS	BOSCH	FIAT	FORD	GM	VW	TOYOTA
"	-	-	-	-	-	-	-	-	3056110155	-
"	-	-	-	-	-	-	-	-	305611015C	-
"	-	-	-	-	-	-	-	-	811611019B	-
"	-	-	-	-	-	-	-	-	ZBA6110150	-
"	-	-	-	-	-	-	-	-	ZBA611015C	-
"	-	-	-	-	-	-	-	-	ZBC611015	-
C-2010	-	-	RCCD00284	-	-	-	-	52269252	-	-
"	-	-	-	-	-	-	-	94625985	-	-
C-2012	6023	-	RCCD00640	-	-	-	-	-	-	-
C-2013	-	-	RCCD00120	-	-	-	-	-	-	-
C-2014	6024	-	RCCD27891	-	-	-	-	-	-	-
C-2015	5431	-	RCCD00055	-	CM 0722S	-	3256110151	-	3256110151	-
"	-	-	RCCD00720	-	-	-	-	-	3256110152	-
"	-	-	RCCD27964	-	-	-	-	-	ZBA611015E	-
C-2016	6336	-	-	-	CM 2124	-	-	94613677	-	-
C-2017	6344	-	RCCM27778	-	-	-	-	-	2116110112	-
C-2018	6091	-	RCCD00500	-	CM 9290	-	-	-	2116110152	-
C-2030	5246	-	RCCD00220	-	CM 9165	5948919	-	-	-	-
"	5765	-	RCCD28261	-	-	5987894	-	-	-	-
C-2032	5421	-	-	-	-	5992891	-	94656136	-	-
"	5799	-	-	-	-	-	-	-	-	-
C-2033	5466	2421200802.3	RCCD00890	PMF131	CM 2596S	7074619	-	-	-	-
"	5766	-	-	-	-	7081967	-	-	-	-
"	-	-	-	-	-	71739128	-	-	-	-
C-2034	-	-	RCCD28200	-	CM 9656	-	-	52273085	-	-
C-2035	-	-	-	-	CM 2594S	7075444	-	-	-	-
"	-	-	-	-	-	7077696	-	-	-	-
"	-	-	-	-	-	71739127	-	-	-	-
C-2036	6348	-	RCCM24841	-	CM 1127	-	-	-	-	-
C-2038	6335	-	RCCD28170	-	-	-	547611015F	-	547611015F	-
C-2039	6341	-	RCCD00160	-	CM 2126	-	85TU2140B	-	-	-
C-2041	5645	-	RCCD01610	-	CM 3253	-	-	93235560	-	-
"	5825	-	-	-	-	-	-	-	-	-
"	6204	-	-	-	-	-	-	-	-	-
C-2042	6022	-	-	-	CM 2590S	7075920	-	-	-	-
"	-	-	-	-	CM 2609	7076333	-	-	-	-
"	-	-	-	-	-	7077697	-	-	-	-
"	-	-	-	-	-	71739998	-	-	-	-
C-2044	6337	-	-	-	CM 1093	-	-	-	-	-
C-2045	6333	-	-	-	CM 1966	-	-	-	-	-
C-2046	5723	2055201058.3	RCCD01000	-	CM 9385	7078627	-	-	-	-
"	-	-	-	-	-	71739129	-	-	-	-
C-2047	-	-	-	-	CM 9686	-	-	94622129	-	-
C-2051	6334	2421231732.3	-	PMK504	CM 1511S	-	547611011	-	547611011	-
"	-	-	-	-	CM 2823	-	7281468	-	-	-
"	-	-	-	-	CM 2929	-	95AB2140AA	-	-	-
"	-	-	-	-	-	-	RF9A2140A	-	-	-
C-2052	6346	-	-	-	CM 2184	-	-	93229039	-	-
C-2053	5999	2421221716.3	-	PMH584	CM 9289	46535126	-	-	-	-
"	10485	-	-	PMH607	-	71739592	-	-	-	-
C-2054	6343	-	RCCD00150	-	CM 2125	9944386	-	-	-	-
C-2055	6349	-	RCCD27875	-	-	9945760	-	-	ZBF611015A	-
"	-	-	-	-	-	9945762	-	-	ZBF611015E	-

Servo Freio	Cilindro de Roda – Linha Leve	Reparos de Hydrovac
Cilindro Mestre	Reparos de Cilindro Mestre	Válvula de Retenção de Vácuo
Cilindro de Embreagem	Reparos de Cilindro de Embreagem	Reservatórios de Líquido de Freio
Cilindro de Roda – Linha Pesada	Reparos de Cilindro de Roda Mangueira do Filtro de Ar	Atuadores Concêntricos de Embreagem

CONTROIL	ATE	TEVES - EUROPE	TRW - VARGA	TRW - LUCAS	BOSCH	FIAT	FORD	GM	VW	TOYOTA
C-2056	-	-	-	-	CM 9797S	9947099	85TU2140A	-	-	-
C-2057	-	-	-	-	CM 0950	9948315	-	-	-	-
C-2058	6041	-	RCCD00180	-	CM 2580	9950677	-	-	377611015A	-
"	-	-	-	-	CM 2931	-	-	-	377611015B	-
C-2059	5108	-	RCCM21631	-	-	-	-	-	1136110215	-
C-2060	-	-	RCCD00140	-	CM 2229	-	3316110153	-	3316110153	-
"	-	-	-	-	CM 2625	-	3316110154	-	3316110154	-
C-2061	-	-	RCCD00910	-	CM 3250	-	96FB2140BE	-	-	-
"	-	-	-	-	-	-	97FU2140AA	-	-	-
C-2062	6332	-	RCCD00980	-	CM 1328	-	-	-	-	-
C-2064	-	-	-	-	-	-	-	RE001204	-	-
C-2065	-	0321202031.3	RCCD00130	PMF148	-	-	-	-	191611019	-
"	-	-	-	PMF503	-	-	-	-	1916110190Z	-
"	-	-	-	-	-	-	-	-	192611019	-
C-2066	-	-	RCCD27972	-	-	-	3316110151	-	3316110151	-
C-2067	6342	0321202651.3	-	PMF480	-	-	-	-	1H1611019	-
"	-	0321203771.3	-	-	-	-	-	-	1H1611019A	-
"	-	0321203943.3	-	-	-	-	-	-	1H1611019C	-
"	-	-	-	-	-	-	-	-	1H2611019	-
"	-	-	-	-	-	-	-	-	357611019	-
C-2068	6340	-	RCCD00292	-	-	-	-	-	-	47201-98001
C-2069	-	-	RCCM00047	-	CM 9207	-	-	-	-	-
C-2071	-	2421221724.3	-	PMH599	CM 2840	-	-	3495542	-	-
"	-	-	-	-	-	-	-	93272847	-	-
C-2073	6330	-	RCCD00990	PML381	CM 2368S	-	-	93217723	-	-
"	-	-	RCCD01030	-	CM 2386S	-	-	-	-	-
C-2074	10137	0321221042.3	-	PMH177	-	-	-	-	192611019B	-
"	-	-	-	-	-	-	-	-	1H1611019B	-
"	-	-	-	-	-	-	-	-	357611019A	-
"	-	-	-	-	-	-	-	-	357611019B	-
C-2075	5695	2055221038.3	RCCD01530	-	-	7078823	-	-	-	-
"	5785	-	-	-	-	7079433	-	-	-	-
"	-	-	-	-	-	71739591	-	-	-	-
C-2076	-	-	RCCM00209	-	-	-	-	-	T06611011	-
"	-	-	RCCM00240	-	-	-	-	-	-	-
C-2077	-	-	-	-	CM 0486S	-	88TU2140AA	-	-	-
C-2078	5571	-	-	-	-	-	-	94652472	-	-
C-2079	-	2421201701.3	RCCD00790	-	-	-	-	-	-	-
C-2080	-	-	-	PMK497	-	9946799	-	-	-	-
C-2081	6338	-	RCCD00940	-	CM 3255	-	97KB2140AB	-	-	-
"	-	-	-	-	-	-	97KU2140AA	-	-	-
C-2082	5954	-	RCCD01620	-	CM 3252	-	-	93289332	-	-
"	5991	-	-	-	-	-	-	-	-	-
C-2083	5703	0321220264.3	-	PMH179	-	-	-	90297376	-	-
C-2084	-	-	RCCM22946	-	-	-	-	-	211611011J	-
C-2086	-	-	RCCM27832	-	CM 9287	-	-	-	-	-
C-2087	-	-	RCCD00690	-	-	-	-	-	-	-
C-2089	6339	-	-	PMK783	-	-	-	-	-	-
C-2090	-	-	RCCD01010	-	CM 3254	-	-	-	-	-
C-2091	6345	-	RCCD00920	-	CM 3251	-	96FB2140DE	-	-	-
"	-	-	-	-	-	-	96FB2140JA	-	-	-
"	-	-	-	-	-	-	97FU2140BA	-	-	-
"	-	-	-	-	-	-	97FU2140CA	-	-	-

Servo Freio	Cilindro de Roda – Linha Leve	Reparos de Hydrovac
Cilindro Mestre	Reparos de Cilindro Mestre	Válvula de Retenção de Vácuo
Cilindro de Embreagem	Reparos de Cilindro de Embreagem	Reservatórios de Líquido de Freio
Cilindro de Roda – Linha Pesada	Reparos de Cilindro de Roda Mangueira do Filtro de Ar	Atuadores Concêntricos de Embreagem

CONTROIL	ATE	TEVES - EUROPE	TRW - VARGA	TRW - LUCAS	BOSCH	FIAT	FORD	GM	VW	TOYOTA
C-2092	6220	-	RCCD00970	-	CM 3257	-	-	93385740	-	-
C-2093	6347	-	RCCD01120	-	CM 3256	-	XS512140AA	-	-	-
C-2094	-	-	RCCD00950	-	-	-	-	93364007	-	-
C-2095	6350	2421231709.3	-	PMK491	-	-	-	-	1J1614019	-
"	10503	-	-	-	-	-	-	-	-	-
C-2096	-	0321204381.3	-	PMF530	CM 2604	-	-	-	-	-
"	-	-	-	PMF532	-	-	-	-	-	-
C-2097	-	2421231734.3	RCCD00960	PMK482	-	-	-	9117554	-	-
"	-	-	RCCD01510	-	-	-	-	9193225	-	-
C-2098	5870	0321231622.3	-	PMK537	-	-	-	90512840	-	-
C-2099	-	-	-	-	CM 2994	-	-	93305031	3256110156	-
C-2100	-	-	RCCD00020	-	CM 2598	-	-	93344930	-	-
"	-	-	-	-	CM 9168	-	-	93364008	-	-
C-2102	-	-	RCCD00497	-	CM 9166	-	-	-	-	-
C-2103	5848	-	RCCD00551	-	CM 9379	-	-	-	-	-
C-2104	-	-	-	-	CM 9823	-	-	94646580	-	-
C-2105	-	-	-	-	CM 0512	-	-	52256125	-	-
"	-	-	-	-	-	-	-	52286807	-	-
C-2106	-	-	RCCD27867	-	-	-	-	-	-	-
C-2107	-	-	-	-	CM 9200	-	-	-	-	-
C-2109	-	-	-	-	CM 0970S	-	-	52253379	-	-
C-2110	-	-	-	-	CM 1939	-	-	93209416	-	-
C-2112	-	-	-	-	CM 8313S	-	-	94649706	-	-
C-2114	-	-	RCCD00170	-	CM 2600	-	-	-	-	-
C-2115	-	-	-	-	CM 3259S	-	-	-	-	-
C-2116	-	-	-	-	CM 1254	-	T71607357	-	-	-
C-2121	-	-	-	-	CM 9785	-	-	-	-	-
C-2124	-	-	-	-	CM 0514S	-	-	-	-	-
C-2125	-	-	RCCD00322	-	-	7507946	-	-	-	-
C-2126	-	-	-	-	CM 1938	-	-	93208199	-	-
C-2127	-	-	-	-	-	-	-	93281898	-	-
C-2128	6060	0321231551.3	-	PMA205	-	-	-	-	-	-
C-2130	6071	0321204321.3	-	PMF494	-	-	-	-	-	-
C-2132	-	-	-	-	-	-	F57Z2140B	-	-	-
"	-	-	-	-	-	-	F67Z2140JA	-	-	-
C-2133	-	-	-	-	-	7076985	-	-	-	-
C-2134	-	-	-	-	CM 2187S	-	-	-	-	-
C-2135	-	2421201706.3	-	PMF364	-	-	-	-	-	-
C-2137	-	2421251703.3	-	PML370	-	9946056	-	-	-	-
"	-	-	-	PML373	-	9948877	-	-	-	-
C-2138	6072	0321221356.3	-	PMH602	-	9948883	-	-	-	-
C-2139	6152	-	-	PMH664	-	7082215	-	-	-	-
C-2140	-	-	-	-	-	7077531	-	-	-	-
C-2141	-	-	-	-	CM 2355	-	-	93326547	-	-
C-2143	-	-	RCCD01460	-	-	-	-	93332850	-	-
C-2146	-	2421231750.3	-	PMK602	-	-	1064284	-	-	-
"	-	-	-	-	-	-	6S4Z2140AA	-	-	-
"	-	-	-	-	-	-	98AB2B507AB	-	-	-
"	-	-	-	-	-	-	YS4Z2004AA	-	-	-
C-2148	-	2421251727.3	-	-	-	-	-	-	2D0611019D	-
C-2149	5486	-	-	-	-	-	-	-	-	-
C-2154	-	-	RCCM00063	-	CM 9206	-	-	-	-	-
C-2155	6168	-	-	-	-	-	2S652140CA	-	-	-

Servo Freio	Cilindro de Roda – Linha Leve	Reparos de Hydrovac
Cilindro Mestre	Reparos de Cilindro Mestre	Válvula de Retenção de Vácuo
Cilindro de Embreagem	Reparos de Cilindro de Embreagem	Reservatórios de Líquido de Freio
Cilindro de Roda – Linha Pesada	Reparos de Cilindro de Roda Mangueira do Filtro de Ar	Atuadores Concêntricos de Embreagem



CONTROIL	ATE	TEVES - EUROPE	TRW - VARGA	TRW - LUCAS	BOSCH	FIAT	FORD	GM	VW	TOYOTA
C-2156	6167	-	-	-	-	-	2S652140AA	-	-	-
C-2157	-	-	-	-	-	-	-	93385741	-	-
C-2158	-	-	-	-	-	-	-	93384797	-	-
C-2159	-	-	RCCM00071	-	-	-	-	-	-	-
"	-	-	RCCM23977	-	-	-	-	-	-	-
"	-	-	RCCM24132	-	-	-	-	-	-	-
"	-	-	RCCM24140	-	-	-	-	-	-	-
"	-	-	RCCM27900	-	-	-	-	-	-	-
C-2160	-	2421201736.3	-	PMF555	-	-	-	-	5Z0611019N	-
"	-	-	-	-	-	-	-	-	5Z1612105Q	-
"	-	-	-	-	-	-	-	-	6Q0611019A	-
"	-	-	-	-	-	-	-	-	6Q0611019G	-
"	-	-	-	-	-	-	-	-	6Q0611019N	-
C-2161	-	2421201749.3	-	PMF537	-	-	-	-	-	47201-02100
"	-	-	-	-	-	-	-	-	-	47201-02270
"	-	-	-	-	-	-	-	-	-	47201-09060
"	-	-	-	-	-	-	-	-	-	47201-09250
"	-	-	-	-	-	-	-	-	-	47201-09470
C-2162	-	-	-	PMZ718	-	-	-	-	-	-
C-2163	-	2421251725.3	-	PML438	-	9949588	-	-	-	-
C-2164	-	-	-	PMK728	-	-	-	-	-	-
C-2165	6209	2421221727.3	-	PMH668	CM 2642	-	-	-	-	-
C-2166	-	2421251728.3	-	PML440	-	-	-	-	-	-
C-2167	-	-	-	PML424	-	-	-	-	-	-
C-2168	-	-	-	-	-	-	-	93354203	-	-
C-2169	-	-	RCCM00030	-	-	-	-	-	-	-
C-2170	-	-	-	PMH923	-	-	-	-	-	-
C-2171	6070	2421231714.3	-	PMK526	-	-	-	-	-	-
C-2172	-	-	-	PMF526	-	-	-	-	-	-
C-2173	6459	-	-	-	-	-	-	-	-	-
C-2174	6476	-	-	-	-	-	-	94735981	-	-
C-2175	6188	-	-	-	-	-	2M5R2B507AA	-	-	-
C-2176	-	-	-	-	-	7085010	-	-	-	-
C-2177	-	-	-	PMF715	-	-	-	-	-	-
"	-	-	-	PMF750	-	-	-	-	-	-
C-2178	6370	-	-	-	-	-	-	-	-	-
C-2180	-	-	-	PMA179	-	-	-	-	-	-
C-2181	-	-	-	-	-	7087529	-	-	-	-
C-2182	-	-	-	-	-	7087526	-	-	-	-
C-2183	-	-	-	PMD731	-	-	-	-	-	-
C-2185	-	-	-	-	-	-	1469140	-	-	-
"	-	-	-	-	-	-	1547478	-	-	-
"	-	-	-	-	-	-	6M512140BB	-	-	-
"	-	-	-	-	-	-	6M512140BC	-	-	-
C-2600	6405	0324196901.3	RCCE00041	PND105	-	-	-	-	-	-
"	-	2424190937.3	-	-	-	-	-	-	-	-
C-2601	6422	-	RCCE00106	-	-	-	-	-	-	-
C-2602	6404	-	RCCE00122	-	-	-	-	-	-	-
C-2603	6403	-	RCCE00238	-	-	-	-	-	-	-
C-2604	6411	-	RCCE00254	-	-	-	E5HT7A543BA	-	-	-
"	-	-	RCCE00680	-	-	-	-	-	-	-
C-2605	6409	-	RCCE00297	-	-	-	2SL721405	-	TF3721405	-
"	-	-	RCCE00480	-	-	-	TAR721405	-	-	-

Servo Freio	Cilindro de Roda – Linha Leve	Reparos de Hydrovac
Cilindro Mestre	Reparos de Cilindro Mestre	Válvula de Retenção de Vácuo
Cilindro de Embreagem	Reparos de Cilindro de Embreagem	Reservatórios de Líquido de Freio
Cilindro de Roda – Linha Pesada	Reparos de Cilindro de Roda Mangueira do Filtro de Ar	Atuadores Concêntricos de Embreagem

CONTROLIL	ATE	TEVES - EUROPE	TRW - VARGA	TRW - LUCAS	BOSCH	FIAT	FORD	GM	VW	TOYOTA
C-2606	6418	-	RCCE00327	-	-	-	-	-	-	-
"	-	-	RCCE00690	-	-	-	-	-	-	-
C-2607	6402	-	RCCE00335	-	-	-	-	-	-	-
C-2608	6412	-	RCCE00149	-	-	-	-	-	T00721405	-
C-2609	6421	-	RCCE00165	-	-	-	-	-	-	31410-98002
C-2610	6407	0325281301.3	RCCE00033	PJN111	-	-	-	-	-	-
C-2611	6410	-	RCCE00114	-	-	-	-	-	-	-
C-2612	6408	-	RCCE00157	-	-	-	-	-	T11721261	-
C-2613	6401	-	RCCE00181	-	-	-	2SK721261	-	2RP721261A	-
"	-	-	RCCE00191	-	-	-	2SL721261	-	2SL721261	-
"	-	-	RCCE00289	-	-	-	2SP721261	-	TAP721261	-
"	-	-	RCCE00386	-	-	-	85HU7A508B	-	TEG721261	-
"	-	-	RCCE00440	-	-	-	88HU7A508AA	-	TJG721261	-
C-2614	6406	-	RCCE00246	-	-	-	96HU7A508AA	-	-	-
C-2615	6414	-	RCCE00319	-	-	-	TAP721261	-	-	-
C-2616	6420	-	RCCE00424	-	-	-	TAR721261	-	TE3721261	-
C-2617	6413	-	RCCE21731	-	-	-	TJG721261	-	-	31470-98001C
C-2618	6426	-	RCCE24838	-	-	-	-	-	-	-
C-2619	6427	-	RCCE00130	-	-	-	-	-	-	31410-98001
C-2620	6416	-	-	-	CM 0105	-	-	-	-	-
C-2621	6419	-	RCCE00361	-	-	-	-	-	-	-
C-2622	6430	-	RCCE00378	-	-	-	-	-	-	-
C-2623	6425	-	RCCE00760	-	-	-	-	-	-	-
C-2624	-	-	RCCE00800	-	-	-	-	93235616	-	-
"	-	-	-	-	-	-	-	93253637	-	-
"	-	-	-	-	-	-	-	93273158	-	-
"	-	-	-	-	-	-	-	93321531	-	-
C-2625	6415	-	RCCE01230	-	-	-	-	93233942	-	-
"	-	-	-	-	-	-	-	93290825	-	-
C-2626	-	-	RCCE00810	-	-	-	-	93206193	-	-
C-2627	6417	-	RCCE01220	-	-	-	-	93206194	-	-
"	-	-	RCCE01240	-	-	-	-	-	-	-
C-2628	6424	-	RCCE00490	-	-	-	2SB721405	-	-	-
C-2629	6423	-	RCCE00500	-	-	-	2S4721405RB	-	-	-
"	-	-	-	-	-	-	2SC721405	-	-	-
C-2630	-	2424191712.3	RCCE00730	PND194	-	-	-	-	2D0721401	-
C-2631	-	2425221703.3	RCCE00750	PJH188	-	-	-	-	2D0721261	-
C-2632	-	2424191729.3	RCCE01020	PND228	-	-	-	-	-	-
C-2633	-	0325252602.3	RCCE00740	PJL102	-	-	-	-	-	-
"	-	-	RCCE01350	-	-	-	-	-	-	-
C-2634	6429	-	-	PNB171	-	-	-	-	-	-
C-2635	6431	-	-	PJD138	-	-	-	-	-	-
C-2637	6428	-	RCCE00650	PNP100	-	-	-	-	-	-
"	-	-	RCCE01170	-	-	-	-	-	-	-
C-2638	-	-	RCCE00820	-	-	-	-	93308109	-	-
C-2641	-	2424191734.3	RCCE01070	PND214	-	-	1014817	-	-	-
"	-	-	-	-	-	-	1017582	-	-	-
"	-	-	-	-	-	-	1038217	-	-	-
"	-	-	-	-	-	-	1045108	-	-	-
"	-	-	-	-	-	-	96FB7A543AA	-	-	-
"	-	-	-	-	-	-	96FB7A543AC	-	-	-
"	-	-	-	-	-	-	96FB7A543AD	-	-	-
"	-	-	-	-	-	-	96FB7A543AE	-	-	-

Servo Freio	Cilindro de Roda – Linha Leve	Reparos de Hydrovac
Cilindro Mestre	Reparos de Cilindro Mestre	Válvula de Retenção de Vácuo
Cilindro de Embreagem	Reparos de Cilindro de Embreagem	Reservatórios de Líquido de Freio
Cilindro de Roda – Linha Pesada	Reparos de Cilindro de Roda Mangueira do Filtro de Ar	Atuadores Concêntricos de Embreagem

CONTROIL	ATE	TEVES - EUROPE	TRW - VARGA	TRW - LUCAS	BOSCH	FIAT	FORD	GM	VW	TOYOTA
"	-	-	-	-	-	-	96FB7A543AF	-	-	-
C-2642	-	2424151703.3	RCCE00890	PNB481	-	-	-	90522656	-	-
"	-	2424151708.3	RCCE00900	PNB541	-	-	-	90578481	-	-
C-2643	-	-	RCCE01090	PND215	-	-	1073706	-	-	-
"	-	-	-	-	-	-	1219805	-	-	-
"	-	-	-	-	-	-	XS617A543AA	-	-	-
C-2644	-	2424151704.3	RCCE00990	PNB467	-	-	-	90523769	-	-
C-2645	-	2424191737.3	RCCE01060	-	-	-	1032202	-	-	-
"	-	-	-	-	-	-	97KB7A543AB	-	-	-
C-2646	-	-	RCCE00880	-	-	-	-	93365179	-	-
C-2647	-	-	RCCE01420	-	-	46754822	-	-	-	-
C-2648	-	-	RCCE01430	-	-	46755264	-	-	-	-
C-2649	-	-	-	-	-	-	1L547A543AC	-	-	-
"	-	-	-	-	-	-	4L5Z7A543AA	-	-	-
"	-	-	-	-	-	-	6L5Z7A543AB	-	-	-
"	-	-	-	-	-	-	F57Z7A543A	-	-	-
"	-	-	-	-	-	-	F87A7A543AC	-	-	-
"	-	-	-	-	-	-	F87A7A543BC	-	-	-
C-2650	-	2424151701.3	RCCE00920	PNB456	-	-	-	-	1J1721388A	-
"	-	-	-	-	-	-	-	-	1J1721388C	-
"	-	-	-	-	-	-	-	-	1J1721388D	-
"	-	-	-	-	-	-	-	-	1J1721388E	-
C-2651	-	-	RCCE01280	PJD241	-	-	-	-	6Q0721261A	-
"	-	-	-	-	-	-	-	-	6Q0721261D	-
"	-	-	-	-	-	-	-	-	6Q0721261F	-
"	-	-	-	-	-	-	-	-	6QE721261	-
C-2652	-	-	-	PNB459	-	-	-	-	-	-
C-2653	-	-	RCCE01360	-	-	-	-	-	-	-
"	-	-	RCCE01370	-	-	-	-	-	-	-
C-2655	-	-	RCCE00710	-	-	-	-	-	-	-
C-2656	-	2425191701.3	RCCE01310	PJD229	-	-	-	-	1J0721261D	-
"	-	-	-	-	-	-	-	-	1J0721261H	-
"	-	-	-	-	-	-	-	-	1J0721261J	-
"	-	-	-	-	-	-	-	-	6N0721261A	-
C-2657	-	2424151702.3	RCCE00930	PNB471	-	-	-	-	6Q0721388	-
"	-	-	-	-	-	-	-	-	6Q0721388A	-
"	-	-	-	-	-	-	-	-	6Q0721388C	-
"	-	-	-	-	-	-	-	-	6Q0721388D	-
C-2658	-	-	RCCE00830	-	-	-	2C347C522FA	-	-	-
"	-	-	-	-	-	-	YC3Z7C522AB	-	-	-
C-2660	-	-	RCCE01260	-	-	-	-	-	-	-
C-2661	-	-	RCCE01120	-	-	-	1148503	-	-	-
"	-	-	-	-	-	-	1197846	-	-	-
"	-	-	-	-	-	-	2S617A543AC	-	-	-
C-2662	-	-	RCCE00940	PNB469	-	-	-	93298712	-	-
C-2664	-	-	-	PJD190	-	-	-	-	-	-
C-2667	-	-	RCCE00950	-	-	-	-	93323612	-	-
C-2668	-	-	RCCE01000	PNB480	-	-	-	90581565	-	-
"	-	-	-	-	-	-	-	93304911	-	-
C-2670	-	-	RCCE01140	PMK150	-	-	-	-	-	-
C-2671	-	-	-	-	-	-	-	-	-	3141012381
C-2672	-	-	-	PNB 334	-	-	-	-	-	31410-35250
"	-	-	-	PNB 380	-	-	-	-	-	31410-35260

Servo Freio	Cilindro de Roda – Linha Leve	Reparos de Hydrovac
Cilindro Mestre	Reparos de Cilindro Mestre	Válvula de Retenção de Vácuo
Cilindro de Embreagem	Reparos de Cilindro de Embreagem	Reservatórios de Líquido de Freio
Cilindro de Roda – Linha Pesada	Reparos de Cilindro de Roda Mangueira do Filtro de Ar	Atuadores Concêntricos de Embreagem

CONTROL	ATE	TEVES - EUROPE	TRW - VARGA	TRW - LUCAS	BOSCH	FIAT	FORD	GM	VW	TOYOTA
C-2673	-	-	-	-	-	-	-	-	-	314200K013
C-2674	-	-	-	PNB502	-	-	-	-	-	31410-35271
C-2676	-	-	-	PJF116	-	-	-	-	-	31470-30220
"	-	-	-	-	-	-	-	-	-	31470-30221
"	-	-	-	-	-	-	-	-	-	31470-30222
C-2678	-	-	-	-	-	-	-	-	-	3147012093
C-2681	-	-	RCCE 0097.0	-	-	-	-	-	-	-
C-2682	-	-	RCCE 0130.0	PJD239	-	-	-	-	-	-
C-2684	-	-	RCCE01080	-	-	-	1M51 7A543 AA	-	-	-
"	-	-	-	-	-	-	98AB 7A543 AF	-	-	-
"	-	-	-	-	-	-	IM51 7A543 AB	-	-	-
C-2688	-	-	-	-	-	-	-	55561915	-	-
C-2690	-	-	-	-	-	-	-	-	2H0 721 401	-
C-2701	-	-	RCAC00080	PJQ131	-	-	-	90522729	-	-
C-2702	-	-	RCAC00010	-	-	-	2S4721261RB	-	-	-
"	-	-	-	-	-	-	4L5Z7A508AB	-	-	-
"	-	-	-	-	-	-	5L5Z7A508A	-	-	-
"	-	-	-	-	-	-	6L5Z7A508AA	-	-	-
"	-	-	-	-	-	-	6L5Z7A508AB	-	-	-
"	-	-	-	-	-	-	9L557A508AA	-	-	-
"	-	-	-	-	-	-	F2T27548A	-	-	-
"	-	-	-	-	-	-	F2T27A564A	-	-	-
"	-	-	-	-	-	-	F4T27548A	-	-	-
"	-	-	-	-	-	-	F5Z7548A	-	-	-
"	-	-	-	-	-	-	F75Z7A508AA	-	-	-
"	-	-	-	-	-	-	F87Z7A508AA	-	-	-
"	-	-	-	-	-	-	F87Z7A508AC	-	-	-
"	-	-	-	-	-	-	YL5Z7A508AA	-	-	-
C-2704	-	-	RCAC00020	-	-	-	-	15061756	-	-
"	-	-	-	-	-	-	-	24235620	-	-
"	-	-	-	-	-	-	-	94670783	-	-
C-2705	-	-	-	PJQ111	-	-	-	24422062	-	-
"	-	-	-	-	-	-	-	55558371	-	-
C-2707	-	-	RCAC00110	-	-	-	2S657A564AA	-	-	-
"	-	-	-	-	-	-	7S657A564AA	-	-	-
"	-	-	-	-	-	-	AM557A564AA	-	-	-
C-2708	-	-	RCAC00030	-	-	-	-	-	-	-
C-2709	-	-	RCAC00050	-	-	-	-	9126238	-	-
C-2710	-	-	-	PJQ114	-	-	-	-	-	-
C-2711	-	-	RCAC00040	PJQ123	-	-	1021237	-	-	-
"	-	-	RCAC00110	-	-	-	1026539	-	-	-
C-2712	-	-	-	-	-	55190965	1075776	-	-	-
"	-	-	-	-	-	73503563	2S657A564AA	-	-	-
C-2715	-	-	-	-	-	-	7S657A564AA	-	0C6 141 671/C/D	-
C-3300	-	-	RCCR23228	-	CR 9360	-	96WT7A564BB	-	-	-
C-3301	-	-	RCCR23244	-	CR 9362	-	AM557A564AA	-	-	-
C-3302	5098	-	RCCR24232	-	CR 9364	-	XS417A564EA	-	-	-
C-3303	5099	-	RCCR24240	-	CR 9365	-	-	-	-	-
C-3304	-	-	RCCR00023	-	CR 9204	-	-	-	-	-
"	-	-	RCCR24089	-	-	-	-	-	-	-
C-3305	-	-	RCCR01930	-	CR 9791	-	85TU2262A	-	-	-
C-3306	-	-	RCCR01940	-	CR 9792	-	85TU2261A	-	-	-
C-3307	-	-	-	-	CR 6078	-	BD2Y2062A	-	-	-

Servo Freio	Cilindro de Roda – Linha Leve	Reparos de Hydrovac
Cilindro Mestre	Reparos de Cilindro Mestre	Válvula de Retenção de Vácuo
Cilindro de Embreagem	Reparos de Cilindro de Embreagem	Reservatórios de Líquido de Freio
Cilindro de Roda – Linha Pesada	Reparos de Cilindro de Roda Mangueira do Filtro de Ar	Atuadores Concêntricos de Embreagem

CONTROIL	ATE	TEVES - EUROPE	TRW - VARGA	TRW - LUCAS	BOSCH	FIAT	FORD	GM	VW	TOYOTA
C-3308	-	-	-	-	CR 6079	-	BD2Y2061A	-	-	-
C-3309	-	-	RCCR24798	-	CR 9983	-	BC9A2062A	-	-	-
C-3310	-	-	RCCR24801	-	CR 9984	-	BC9A2061A	-	-	-
C-3311	-	-	-	-	-	-	BD2Y2262A	-	-	-
C-3312	-	-	-	-	-	-	BD2Y2261A	-	-	-
C-3313	-	-	-	-	CR 7188	-	BD5T2262A	-	-	-
C-3314	-	-	-	-	CR 7189	-	BD5T2261A	-	-	-
C-3315	-	-	-	-	CR 7782	502392	BD9T2262A	-	-	-
C-3316	-	-	-	-	CR 7783	502393	BD9T2261A	-	-	-
C-3317	-	-	-	-	CR 7784	-	BD9T2W037A	-	-	-
C-3318	-	-	-	-	CR 7785	-	BD9T2W036A	-	-	-
C-3319	-	-	-	-	CR 7315	-	-	94601661	-	-
C-3320	-	-	-	-	CR 8158	-	-	94613373	T11611077	-
C-3321	-	-	-	-	CR 8159	-	-	94613374	T11611078	-
C-3322	-	-	-	-	CR 8160	-	-	94613375	T11611079	-
C-3323	-	-	-	-	CR 8161	-	-	94613376	T11611080	-
C-3324	-	-	RCCR24305	-	CR 6892	-	-	7332945	-	-
C-3325	-	-	RCCR24313	-	CR 6893	-	-	7332946	-	-
C-3326	-	-	RCCR24321	-	CR 6894	-	-	7332953	-	-
C-3327	-	-	RCCR24331	-	CR 6895	-	-	7332954	-	-
C-3328	-	-	-	-	CR 8165	-	-	94613311	-	-
C-3329	-	-	-	-	CR 8166	-	-	94613312	-	-
C-3330	-	-	-	-	CR 8167	-	-	94613309	-	-
C-3331	-	-	-	-	CR 8168	-	-	94613310	-	-
C-3332	-	-	RCCR00163	-	CR 9205	-	-	-	-	-
C-3333	-	-	RCCR01232	-	CR 9152	-	-	-	2RA611049A	-
"	-	-	-	-	-	-	-	-	T06611049A	-
C-3334	-	-	RCCR00171	-	-	-	-	-	-	-
C-3335	-	-	-	-	CR 9357	-	-	94648563	-	-
C-3336	-	-	-	-	CR 9358	-	-	94648564	-	-
C-3337	-	-	-	-	CR 2387	-	2SH611049	-	-	-
C-3338	-	-	-	-	CR 2388	-	2SH611050	-	-	-
C-3350	5345	0332140811.3	RCCR00384	BWA108	CR 2002	-	3056110514	-	171611051A	-
"	-	0332140812.3	-	BWA108A	-	-	-	-	171611051B	-
"	-	2432140902.3	-	-	-	-	-	-	171611053	-
"	-	-	-	-	-	-	-	-	171611053A	-
"	-	-	-	-	-	-	-	-	1H0611053B	-
"	-	-	-	-	-	-	-	-	3056110514	-
"	-	-	-	-	-	-	-	-	V03795520	-
C-3351	5105	0332222812.3	RCCR21578	BWH213	CR 9851	-	-	-	113611057	-
"	-	0332225211.3	RCCR23211	-	-	-	-	-	1136110571	-
"	-	-	-	-	-	-	-	-	1136110578	-
"	-	-	-	-	-	-	-	-	113611057A	-
"	-	-	-	-	-	-	-	-	113611057B	-
"	-	-	-	-	-	-	-	-	131611057	-
"	-	-	-	-	-	-	-	-	131611057A	-
"	-	-	-	-	-	-	-	-	131611057B	-
C-3352	5102	-	RCCR23805	-	CR 9874	-	-	-	1136110551	-
C-3353	5374	2432190803.3	RCCR00686	BWD110	CR 9175	5987896	-	-	-	-
"	5760	2432191103.3	RCCR01400	BWD283	-	7077174	-	-	-	-
C-3354	6265	-	RCCR02100	BWD289	CR 8667	71738328	-	94622251	-	-
"	-	-	RCCR02210	BWD317	-	7696710	-	-	-	-
C-3355	5097	2432190801.3	RCCR00694	BWD103	CR 9174	3980011	-	-	-	-

Servo Freio	Cilindro de Roda – Linha Leve	Reparos de Hydrovac
Cilindro Mestre	Reparos de Cilindro Mestre	Válvula de Retenção de Vácuo
Cilindro de Embreagem	Reparos de Cilindro de Embreagem	Reservatórios de Líquido de Freio
Cilindro de Roda – Linha Pesada	Reparos de Cilindro de Roda Mangueira do Filtro de Ar	Atuadores Concêntricos de Embreagem

CONTROL	ATE	TEVES - EUROPE	TRW - VARGA	TRW - LUCAS	BOSCH	FIAT	FORD	GM	VW	TOYOTA
"	5744	-	RCCR01410	-	-	4121616	-	-	-	-
C-3356	5346	0332172111.3	RCCR00619	BWC107	CR 9167	4347258	3096110531	-	309611051	-
"	5841	0332172112.3	RCCR01390	BWC107A	-	4373614	-	-	3096110511	-
"	-	0332172113.3	RCCR02930	-	-	4394460	-	-	309611053	-
"	-	2432170908.3	-	-	-	71738329	-	-	3096110531	-
"	-	-	-	-	-	7621101	-	-	321611053A	-
"	-	-	-	-	-	790049	-	-	331611051	-
"	-	-	-	-	-	790215	-	-	331611051A	-
"	-	-	-	-	-	-	-	-	331611053	-
"	-	-	-	-	-	-	-	-	331611053A	-
"	-	-	-	-	-	-	-	-	331611053B	-
"	-	-	-	-	-	-	-	-	331611058A	-
"	-	-	-	-	-	-	-	-	5U0611053	-
"	-	-	-	-	-	-	-	-	6N0611053	-
"	-	-	-	-	-	-	-	-	6Q0611053C	-
"	-	-	-	-	-	-	-	-	6QE611053	-
C-3357	5103	-	RCCR23988	-	-	-	-	-	3116110671	-
C-3358	5713	-	-	-	CR 8252	-	BD9M2262X	-	-	-
C-3359	5714	-	-	-	CR 8253	-	BD9M2261X	-	-	-
C-3362	6272	-	RCCR00856	-	CR 7924	-	-	94606707	-	-
"	-	-	RCCR01420	-	-	-	-	-	-	-
C-3363	6273	-	RCCR00864	-	CR 7925	-	-	94606708	-	-
"	-	-	RCCR01430	-	-	-	-	-	-	-
C-3364	5302	-	RCCR00325	-	CR 9828	-	-	94632665	-	-
C-3365	5303	-	RCCR00333	-	CR 9829	-	-	94632666	-	-
C-3366	5269	-	RCCR00767	-	CR 9294	-	-	-	2116110473	-
"	5903	-	-	-	-	-	-	-	-	-
C-3367	-	-	RCCR27851	-	-	-	-	-	2116110471	-
C-3368	6448	-	RCCR00848	-	-	-	554611051	-	-	-
"	-	-	-	-	-	-	BE2P2261A	-	-	-
C-3369	5446	-	RCCR00473	-	CR 9190	-	-	52252479	-	-
"	5820	-	RCCR01360	-	-	-	-	-	-	-
C-3370	5447	-	RCCR00481	-	CR 9191	-	-	52252480	-	-
"	5821	-	RCCR01370	-	-	-	-	-	-	-
C-3371	5519	-	RCCR00521	-	-	-	-	94613671	-	-
C-3372	5520	-	RCCR00538	-	-	-	-	94613672	-	-
C-3373	6085	-	RCCR00155	-	CR 9178	-	-	94656167	-	-
C-3374	6086	-	RCCR02110	-	CR 9416	-	-	94656083	-	-
"	-	-	RCCR02220	-	-	-	-	-	-	-
C-3375	5100	0332171811.3	RCCR23295	BWC120	CR 9875	-	-	-	1136110531	-
"	-	-	-	-	-	-	-	-	113611053A	-
"	-	-	-	-	-	-	-	-	113611053B	-
C-3376	-	-	RCCR01240	-	CR 2057	-	2S4611049	-	-	-
"	-	-	-	-	-	-	85TU2262D	-	-	-
C-3377	-	-	RCCR01259	-	CR 2058	-	2S4611050	-	-	-
"	-	-	-	-	-	-	85TU2261D	-	-	-
C-3378	6329	-	-	-	-	-	-	-	-	-
C-3379	6328	-	-	-	-	-	-	-	-	-
C-3380	6326	-	-	-	-	-	-	-	-	-
C-3381	6325	-	-	-	-	-	-	-	-	-
C-3382	6287	-	RCCR00406	-	-	-	-	-	-	47580-98001B
C-3383	6284	-	RCCR00422	-	-	-	-	-	-	47570-98001B
C-3384	6286	-	RCCR00392	-	-	-	-	-	-	47560-98001B

Servo Freio	Cilindro de Roda – Linha Leve	Reparos de Hydrovac
Cilindro Mestre	Reparos de Cilindro Mestre	Válvula de Retenção de Vácuo
Cilindro de Embreagem	Reparos de Cilindro de Embreagem	Reservatórios de Líquido de Freio
Cilindro de Roda – Linha Pesada	Reparos de Cilindro de Roda Mangueira do Filtro de Ar	Atuadores Concêntricos de Embreagem



CONTROIL	ATE	TEVES - EUROPE	TRW - VARGA	TRW - LUCAS	BOSCH	FIAT	FORD	GM	VW	TOYOTA
C-3385	6285	-	RCCR00414	-	-	-	-	-	-	47550-98001B
C-3386	6299	-	RCCR00430	-	-	-	-	-	-	47520-98001
C-3387	6302	-	RCCR00449	-	-	-	-	-	-	47540-98001
C-3388	6301	-	RCCR00457	-	-	-	-	-	-	47510-98001
C-3389	6300	-	RCCR00465	-	-	-	-	-	-	47530-98001
C-3390	6318	-	-	-	-	-	-	-	-	-
C-3391	6317	-	-	-	-	-	-	-	-	-
C-3392	6313	-	RCCR01440	-	-	-	-	7362868	-	-
"	-	-	RCCR21292	-	-	-	-	-	-	-
C-3393	6314	-	RCCR01450	-	-	-	-	7362867	-	-
"	-	-	RCCR21306	-	-	-	-	-	-	-
C-3394	5518	-	RCCR00491	-	CR 9177	-	-	94622164	-	-
"	5795	-	RCCR01380	-	-	-	-	-	-	-
C-3395	6307	-	RCCR24003	-	-	-	-	7329085	-	-
C-3396	6305	-	RCCR24011	-	-	-	-	7329086	-	-
C-3397	5514	-	RCCR00368	-	-	-	BD9M2262Y	-	-	-
C-3398	5515	-	RCCR00376	-	-	-	BD9M2261Y	-	-	-
C-3399	6324	-	RCCR22965	-	-	-	-	-	2116110691	-
C-3400	6322	-	RCCR22973	-	-	-	-	-	2116110701	-
C-3401	6293	-	RCCR22981	-	-	-	-	-	2116110691	-
C-3402	6292	-	RCCR22991	-	-	-	-	-	2116110701	-
C-3403	6323	-	RCCR22957	-	-	-	-	-	211611047B	-
C-3404	5465	-	RCCR00899	-	-	7074617	-	-	-	-
C-3405	5448	-	RCCR00821	-	CR 9866	-	-	52252573	-	-
C-3406	5449	-	RCCR00831	-	CR 9867	-	-	52252574	-	-
C-3407	5101	0332193211.3	RCCR21561	-	CR 9873	-	-	-	113611055B	-
"	-	-	RCCR23201	-	-	-	-	-	113611055C	-
"	-	-	-	-	-	-	-	-	131611055	-
"	-	-	-	-	-	-	-	-	131611055A	-
C-3408	6087	-	RCCR02040	-	CR 0699	-	-	52258421	-	-
C-3409	6088	-	RCCR02050	-	CR 0700	-	-	52258422	-	-
C-3410	6013	0332196311.3	RCCR01305	BWD119	CR 2754	-	-	90443261	-	-
"	-	2432191715.3	-	BWD119A	-	-	-	90498300	-	-
"	-	-	-	BWK220	-	-	-	93284550	-	-
C-3411	5684	2432201116.3	RCCR01950	BWF254	CR 1687	60809966	-	93330205	-	-
"	5780	2432201704.3	RCCR02120	BWF278	-	7082150	-	96574718	-	-
C-3412	6014	0332194301.3	RCCR01283	BWD195	CR 3002	71737950	1006016	-	547611051A	-
"	-	0332194302.3	-	BWD287	-	71737951	1104132	-	-	-
"	-	2432191107.3	-	BWD288	-	7729634	1484750	-	-	-
C-3413	6000	2432221701.3	RCCR01960	BWF253	CR 9157	7740758	1486316	-	-	-
"	-	2432191720.3	-	-	-	9950817	1486750	-	-	-
C-3414	6089	2432191743.3	RCCR02060	-	CR 0701	98845068	1517559	52258423	-	-
C-3415	6090	-	RCCR02070	-	CR 0702	9947943	547611051A	52258424	-	-
C-3417	6262	-	RCCR01970	-	CR 2408	-	6106584	93233867	-	-
"	-	-	RCCR02130	-	-	-	6196052	93233869	-	-
"	-	-	RCCR02190	-	-	-	72GB2261AA	-	-	-
C-3418	6261	-	RCCR01980	-	CR 2409	-	91AB2261BA	93233868	-	-
"	-	-	RCCR02140	-	-	-	96FB2261BA	93233870	-	-
"	-	-	RCCR02200	-	-	-	XS512261BA	-	-	-
C-3419	6316	-	RCCR01460	-	-	-	-	7364725	-	-
"	-	-	RCCR21535	-	-	-	-	-	-	-
C-3420	6315	-	RCCR01470	-	-	-	-	7364726	-	-
"	-	-	RCCR21540	-	-	-	-	-	-	-

Servo Freio	Cilindro de Roda – Linha Leve	Reparos de Hydrovac
Cilindro Mestre	Reparos de Cilindro Mestre	Válvula de Retenção de Vácuo
Cilindro de Embreagem	Reparos de Cilindro de Embreagem	Reservatórios de Líquido de Freio
Cilindro de Roda – Linha Pesada	Reparos de Cilindro de Roda Mangueira do Filtro de Ar	Atuadores Concêntricos de Embreagem

CONTROIL	ATE	TEVES - EUROPE	TRW - VARGA	TRW - LUCAS	BOSCH	FIAT	FORD	GM	VW	TOYOTA
C-3421	-	-	-	-	-	-	-	7364725	-	-
C-3422	-	-	-	-	-	-	-	7364726	-	-
C-3426	-	-	-	-	-	-	-	95018639	-	-
C-3427	6996	-	-	-	-	7088679	-	-	-	-
C-3428	6986	-	-	-	-	7088676	-	-	-	-
C-3429	-	-	-	-	-	6987	-	-	-	-
"	-	-	-	-	-	7088827	-	-	-	-
C-3435	-	-	-	-	CR 1459	-	547611049	-	547611049	-
C-3436	-	-	-	-	CR 1460	-	547611050	-	547611050	-
C-3437	5727	-	RCCR01990	BWD319	CR 9291	7078624	-	-	-	-
C-3439	5516	0332172202.3	RCCR00945	BWC189	CR 3001	-	1006013	93305403	545511051	-
"	5517	0332172204.3	RCCR00953	BWC245	CR 9858	-	1104131	93336460	-	-
"	-	2432171715.3	RCCR01910	BWC246	CR 9859	-	1484752	93336461	-	-
C-3440	6214	0332190905.3	RCCR00015	BWD113	-	-	1517558	-	1H0611053	-
"	6279	2432190905.3	RCCR27860	BWD113A	-	-	542611051	-	3086110531	-
"	-	2432190909.3	-	-	-	-	72GB2261BA	-	6Q0611053B	-
"	-	2732000108.3	-	-	-	-	88AR2262A	-	6QE611053A	-
"	-	-	-	-	-	-	96FB2261AA	-	861611053	-
"	-	-	-	-	-	-	XS512261AA	-	V03795053	-
C-3441	6267	-	RCCR02080	-	CR 2915	-	-	93215633	-	-
C-3442	6266	-	RCCR02090	-	CR 2916	-	-	93215634	-	-
C-3444	6289	-	RCCR00872	-	CR 7798	-	-	94606705	-	-
C-3445	6288	-	RCCR00880	-	CR 7799	-	-	94606706	-	-
C-3446	6290	-	-	-	CR 8704	-	-	94622231	-	-
C-3447	6291	-	-	-	CR 8705	-	-	94622232	-	-
C-3448	6306	-	RCCR03280	-	CR 3007	-	-	-	-	-
C-3449	6308	-	RCCR03260	-	CR 3006	-	-	-	-	-
C-3450	6283	-	-	-	-	-	-	-	-	-
C-3451	6282	-	-	-	-	-	-	-	-	-
C-3452	6294	-	-	-	-	-	-	-	-	-
C-3453	6295	-	-	-	-	-	-	-	-	-
C-3454	6304	2432251102.3	RCCR03000	BWL195	-	-	69021740	-	-	-
C-3456	6260	-	-	-	CR 2955	-	-	93260019	-	-
C-3457	6259	-	-	-	CR 2956	-	-	93260020	-	-
C-3458	6268	-	-	-	CR 7568	-	84PU2262A	-	-	-
C-3459	6269	-	-	-	CR 7569	-	84PU2261A	-	-	-
C-3460	6320	-	-	-	CR 9834	-	88TU2262B	-	-	-
C-3461	-	-	-	-	CR 9835	-	88TU2261B	-	-	-
C-3462	6296	0332201801.3	RCCR01920	BWF193	-	-	1006011	-	-	-
"	-	0332201803.3	-	BWF306	-	-	1126532	-	-	-
C-3463	6309	2432231106.3	-	BWK119	-	-	1484751	RE002064	-	-
"	-	2732001016.3	-	-	-	-	6009659	RE003084	-	-
C-3464	6298	-	RCCR02390	-	-	-	6196051	RE003086	-	-
C-3465	6297	-	RCCR02400	-	-	-	72GB2261CA	-	-	-
C-3466	6281	-	RCCR00980	-	CR 2587	-	5L552262AA	-	-	-
C-3467	6280	-	RCCR00990	-	CR 2588	-	5L552261AA	-	-	-
C-3468	6319	-	RCCR00341	-	-	-	YS4Z2261AA	94613257	-	-
C-3469	6321	-	RCCR00351	-	-	-	-	94613258	-	-
C-3470	6263	2432221116.3	RCCR02010	BWH231	CR 3014	-	6808556	-	-	-
"	-	-	-	-	-	-	93BB2261DC	-	-	-
"	-	-	-	-	-	-	93BB2261DD	-	-	-
"	-	-	-	-	-	-	97FB2261BB	-	-	-
C-3471	6215	2432201716.3	RCCR03330	BWF145	CR 2905	-	-	-	357611053B	-

Servo Freio	Cilindro de Roda – Linha Leve	Reparos de Hydrovac
Cilindro Mestre	Reparos de Cilindro Mestre	Válvula de Retenção de Vácuo
Cilindro de Embreagem	Reparos de Cilindro de Embreagem	Reservatórios de Líquido de Freio
Cilindro de Roda – Linha Pesada	Reparos de Cilindro de Roda Mangueira do Filtro de Ar	Atuadores Concêntricos de Embreagem

CONTROIL	ATE	TEVES - EUROPE	TRW - VARGA	TRW - LUCAS	BOSCH	FIAT	FORD	GM	VW	TOYOTA
"	-	-	-	BWF295	-	-	-	-	376611051	-
"	-	-	-	-	-	-	-	-	6U0611053	-
<b>C-3472</b>	5958	2055192092.3	RCCR02880	BWD284	CR 3009	7081423	2S652261AA	-	-	-
"	-	-	-	-	-	7081575	-	-	-	-
"	-	-	-	-	-	7084406	-	-	-	-
<b>C-3473</b>	-	2432171705.3	-	BWC227	-	-	-	-	-	-
"	-	2732001080.3	-	-	-	-	-	-	-	-
<b>C-3474</b>	6351	2432191116.3	-	BWD131	-	-	-	-	-	-
"	-	2732001073.3	-	-	-	-	-	-	-	-
<b>C-3475</b>	6352	2432191117.3	-	BWD132	-	-	-	-	-	-
"	-	2732001074.3	-	-	-	-	-	-	-	-
<b>C-3476</b>	6353	2432221122.3	-	BWH140	-	-	-	-	-	-
"	-	2432221613.3	-	-	-	-	-	-	-	-
"	-	2732001027.3	-	-	-	-	-	-	-	-
<b>C-3477</b>	6354	2432221123.3	-	BWH141	-	-	-	-	-	-
"	-	2732001028.3	-	-	-	-	-	-	-	-
<b>C-3478</b>	6274	2432201711.3	RCCR02860	BWF252	CR 3016	7086715	-	-	-	-
"	-	2732000327.3	-	-	-	-	-	-	-	-
<b>C-3479</b>	6327	2432221615.3	-	BWH146	-	-	-	-	-	-
"	-	2732000803.3	-	-	-	-	-	-	-	-
"	-	2732000814.3	-	-	-	-	-	-	-	-
<b>C-3480</b>	6311	2432000908.3	-	BWF145A	-	-	-	-	1J0611053	-
"	-	2432200909.3	-	-	-	-	-	-	3A0611053	-
<b>C-3481</b>	6277	2432191723.3	RCCR01810	BWD265	-	-	-	-	-	-
"	-	-	-	BWD341	-	-	-	-	-	-
<b>C-3482</b>	6278	2432191724.3	RCCR01820	BWD245	-	-	-	-	-	-
"	-	-	-	BWD246	-	-	-	-	-	-
"	-	-	-	BWD342	-	-	-	-	-	-
<b>C-3483</b>	6264	-	RCCR02000	BWH310	CR 3003	-	-	-	-	47550-26110
"	-	-	-	BWK701	-	-	-	-	-	47550-35200
<b>C-3484</b>	6275	-	RCCR01610	BWC178	-	-	-	-	-	47570-12030
"	-	-	-	BWC220	-	-	-	-	-	47570-16010
<b>C-3485</b>	6276	-	RCCR01620	BWC179	-	-	-	-	-	47550-12090
"	-	-	-	BWC221	-	-	-	-	-	47550-16030
<b>C-3486</b>	-	2432261701.3	-	BWN240	-	9945891	-	-	-	47550-16060
"	-	2432261702.3	-	BWN523	-	-	-	-	-	47550-19155
<b>C-3489</b>	-	2432201111.3	-	BWF191	-	-	1113641	-	-	47550-20120
"	-	-	-	-	-	-	6508824	-	-	-
"	-	-	-	-	-	-	6808555	-	-	-
"	-	-	-	-	-	-	93BB2261BC	-	-	-
"	-	-	-	-	-	-	93BB2261BD	-	-	-
"	-	-	-	-	-	-	F5RZ2261A	-	-	-
<b>C-3490</b>	6446	2432171710.3	RCCR02910	BWA129	CR 3013	-	-	-	-	-
<b>C-3491</b>	-	-	RCCR03010	BWH380	-	-	-	-	-	47550-35190
<b>C-3492</b>	-	-	-	-	CR 2922	-	-	93294390	-	-
<b>C-3493</b>	-	-	-	-	CR 2923	-	-	93294391	-	-
<b>C-3494</b>	7229	-	RCCR03340	-	CR 2020	-	BF8T2261A	-	-	-
<b>C-3495</b>	7230	-	RCCR03360	-	CR 2021	-	BF8T2261B	-	-	-
<b>C-3496</b>	6098	-	RCCR03440	-	CR 3011	7081424	2S652261BA	-	-	-
"	-	-	-	-	-	7084405	-	-	-	-
<b>C-3497</b>	-	-	-	-	-	-	F87A2261AA	-	-	-
<b>C-3498</b>	6270	-	RCCR03020	BWH309	-	-	-	-	-	-
<b>C-3499</b>	6271	-	RCCR03030	BWH312	-	-	-	-	-	-

Servo Freio	Cilindro de Roda – Linha Leve	Reparos de Hydrovac
Cilindro Mestre	Reparos de Cilindro Mestre	Válvula de Retenção de Vácuo
Cilindro de Embreagem	Reparos de Cilindro de Embreagem	Reservatórios de Líquido de Freio
Cilindro de Roda – Linha Pesada	Reparos de Cilindro de Roda	Atuadores Concêntricos de Embreagem
	Mangueira do Filtro de Ar	

CONTROL	ATE	TEVES - EUROPE	TRW - VARGA	TRW - LUCAS	BOSCH	FIAT	FORD	GM	VW	TOYOTA
C-3500	6447	-	RCCR02890	-	CR 3010	-	-	93306552	-	-
"	-	-	-	-	-	-	-	93306553	-	-
C-3501	-	2432171709.3	-	BWA130	-	-	-	-	-	-
C-3502	-	2432191729.3	-	BWD267	-	-	-	-	-	47570-20060
C-3503	-	2432191730.3	-	BWD266	-	-	-	-	-	47550-20150
C-3504	-	-	-	-	-	-	1L5Z2261GA	-	-	-
"	-	-	-	-	-	-	F87Z2261BA	-	-	-
C-3505	7215	2432221711.3	RCCR02920	BWH373	CR 3015	-	-	-	-	-
C-3506	-	-	-	BWF724	-	-	-	-	-	-
C-3507	-	-	-	BWD328	-	-	-	-	-	-
"	-	-	-	BWD329	-	-	-	-	-	-
C-3508	-	-	-	BWF323	-	-	-	-	-	-
"	-	-	-	BWF324	-	-	-	-	-	-
"	-	-	-	BWF329	-	-	-	-	-	-
C-3510	7231	2432281701.3	RCCR03100	BWN245	-	9945895	-	-	-	-
"	-	2732000854.3	-	-	-	-	-	-	-	-
C-3511	7612	2432201617.3	RCCR02950	BWF166	CR 2727	-	-	-	-	-
"	-	2732001062.3	-	BWF170	-	-	-	-	-	-
C-3512	7602	2432201618.3	RCCR02960	BWF167	CR 2728	-	-	-	-	-
"	-	2732001063.3	-	BWF171	-	-	-	-	-	-
C-3515	7253	2432191731.3	RCCR03140	BWB169	-	-	-	-	-	-
"	-	-	-	BWD292	-	-	-	-	-	-
C-3516	7254	2432191732.3	RCCR03160	BWB168	-	-	-	-	-	-
"	-	-	-	BWD293	-	-	-	-	-	-
C-3517	-	-	-	BWL177	-	-	-	-	-	47550-35210
"	-	-	-	BWL203	-	-	-	-	-	-
"	-	-	-	BWL289	-	-	-	-	-	-
"	-	-	-	BWL704	-	-	-	-	-	-
C-3518	-	2432221114.3	-	BWH232	-	-	1115986	-	-	-
"	-	-	-	-	-	-	6808557	-	-	-
"	-	-	-	-	-	-	93BB2261EC	-	-	-
"	-	-	-	-	-	-	93BB2261ED	-	-	-
"	-	-	-	-	-	-	F5RZ2261B	-	-	-
C-3519	-	2432191112.3	-	BWD135	-	-	-	-	-	-
"	-	2732000846.3	-	-	-	-	-	-	-	-
C-3520	7256	2432171717.3	RCCR03380	BWC244	CR 3012	-	-	-	-	-
C-3521	-	-	-	-	CR 2202	-	-	93313891	-	-
C-3522	-	2432201601.3	-	BWF125	-	-	-	-	-	-
"	-	2432201615.3	-	BWF127	-	-	-	-	-	-
"	-	2432201713.3	-	BWF129	-	-	-	-	-	-
"	-	2732000319.3	-	BWF287	-	-	-	-	-	-
C-3523	-	2432201602.3	-	BWF126	-	-	-	-	-	-
"	-	2432201616.3	-	BWF128	-	-	-	-	-	-
"	-	2432201714.3	-	BWF130	-	-	-	-	-	-
"	-	2732000320.3	-	BWF288	-	-	-	-	-	-
C-3524	-	2432191739.3	-	BWD304	-	-	-	-	-	-
"	-	2732001059.3	-	BWD307T	-	-	-	-	-	-
C-3525	-	2432191740.3	-	BWD305	-	-	-	-	-	-
"	-	-	-	BWD307T	-	-	-	-	-	-
C-3526	-	2432221715.3	-	BWH392	CR 1272	-	-	-	-	-
C-3527	7600	0332152311.3	RCCR03510	BWB111	-	-	-	-	1H0611053A	-
"	-	2432150903.3	-	BWB111A	-	-	-	-	5U0611053A	-
"	-	-	-	-	-	-	-	-	5U0611053C	-

Servo Freio	Cilindro de Roda – Linha Leve	Reparos de Hydrovac
Cilindro Mestre	Reparos de Cilindro Mestre	Válvula de Retenção de Vácuo
Cilindro de Embreagem	Reparos de Cilindro de Embreagem	Reservatórios de Líquido de Freio
Cilindro de Roda – Linha Pesada	Reparos de Cilindro de Roda Mangueira do Filtro de Ar	Atuadores Concêntricos de Embreagem

CONTROIL	ATE	TEVES - EUROPE	TRW - VARGA	TRW - LUCAS	BOSCH	FIAT	FORD	GM	VW	TOYOTA
"	-	-	-	-	-	-	-	-	861611051A	-
"	-	-	-	-	-	-	-	-	861611053A	-
C-3528	-	-	-	BWK160	-	-	-	-	-	-
C-3529	-	-	-	BWK161	-	-	-	-	-	-
C-3531	-	-	-	-	-	-	-	-	-	47550-09080
C-3532	-	2432221727.3	-	BWH406	-	-	-	91174801	-	-
"	-	-	-	BWH714	-	-	-	-	-	-
C-3533	-	2432221728.3	-	BWH405	-	-	-	91174800	-	-
"	-	-	-	BWH713	-	-	-	-	-	-
C-3534	-	-	-	BWH266	-	-	-	-	J4755026090	47550-26090
"	-	-	-	-	-	-	-	-	-	47550-29265
"	-	-	-	-	-	-	-	-	-	47550-39115
C-3535	-	2432201717.3	-	BWF290	-	-	-	-	-	-
C-3537	-	2432171711.3	-	BWC243	-	-	-	-	-	-
C-3538	-	2432191756.3	-	BWD100	-	71742838	-	-	-	-
"	-	-	-	BWD327	-	-	-	-	-	-
C-3539	2432201721.3	-	-	BWF318	986475927	-	-	-	-	-
C-3540	-	24.3215-1703.3	-	BWB147	-	-	-	-	-	-
C-3541	-	-	-	-	-	-	-	96574719	-	-
C-3542	-	-	-	-	204011571	-	-	-	-	-
C-3543	-	-	-	-	02042L2932	-	-	-	2H0611053	-
C-3544	-	-	-	-	02042M2187	-	-	-	-	-
C-3546	6995	-	-	-	-	-	CN152261AA	-	-	-
C-5600	5258	-	RCSF00018	-	SF 9170	-	-	-	3056120513	-
"	5847	-	RCSF00026	-	-	-	-	-	3056121053	-
C-5601	6433	-	RCSF00180	-	-	-	89EU2055AA	-	-	-
"	-	-	RCSF00311	-	-	-	BE1M2005B	-	-	-
"	-	-	SCSF00139	-	-	-	BF0E2005A	-	-	-
C-5602	-	-	-	-	SF 3417	-	-	94622158	-	-
C-5603	6439	-	-	-	SF 2764S	-	542611905	-	542611905	-
"	-	-	-	-	SF 3940S	-	6089688	-	-	-
"	-	-	-	-	-	-	81AB2005BB	-	-	-
"	-	-	-	-	-	-	88AR2005C	-	-	-
C-5604	5257	0361407200.4	RCSF00034	-	-	-	-	-	ZBA612105E	-
"	6441	-	RCSF00557	-	-	-	-	-	ZBA612105J	-
"	-	-	SCSF00368	-	-	-	-	-	ZBA612105L	-
C-5607	6432	-	RCSF00689	-	-	-	-	-	2116119051	-
"	-	-	SCSF00309	-	-	-	-	-	2116119055	-
"	-	-	SCSF26091	-	-	-	-	-	2116119076	-
C-5608	6435	0368505000.4	RCSF00565	-	SF 5341S	-	3256121072	-	3256121072	-
"	-	-	-	-	-	-	3256121077	-	3256121077	-
"	-	-	-	-	-	-	3256121078	-	3256121078	-
"	-	-	-	-	-	-	3316121071	-	3316121071	-
"	-	-	-	-	-	-	-	-	811612107B	-
"	-	-	-	-	-	-	-	-	ZBC611907A	-
C-5609	6438	-	RCSF00425	-	-	-	-	94652906	-	-
"	-	-	RCSF00573	-	-	-	-	-	-	-
"	-	-	SCSF00260	-	-	-	-	-	-	-
C-5610	6437	-	RCSF00621	-	SF 3950	-	-	52256133	-	-
"	-	-	-	-	-	-	-	52286810	-	-
C-5612	-	-	-	-	SF 3323	-	-	94613676	-	-
C-5613	5558	-	-	-	-	7074724	-	-	-	-
"	5764	-	-	-	-	7075450	-	-	-	-

Servo Freio	Cilindro de Roda – Linha Leve	Reparos de Hydrovac
Cilindro Mestre	Reparos de Cilindro Mestre	Válvula de Retenção de Vácuo
Cilindro de Embreagem	Reparos de Cilindro de Embreagem	Reservatórios de Líquido de Freio
Cilindro de Roda – Linha Pesada	Reparos de Cilindro de Roda Mangueira do Filtro de Ar	Atuadores Concêntricos de Embreagem

CONTROIL	ATE	TEVES - EUROPE	TRW - VARGA	TRW - LUCAS	BOSCH	FIAT	FORD	GM	VW	TOYOTA
C-5614	6436	-	RCSF00611	-	SF 3956	-	-	52256123	-	-
"	-	-	-	-	-	-	-	52286809	-	-
C-5616	5420	-	-	-	-	-	-	94656135	-	-
"	5798	-	-	-	-	-	-	-	-	-
C-5617	6434	-	RCSF00913	-	SF 3330S	-	BEOC2005A	-	-	-
"	-	-	-	-	SF 3401	-	-	-	-	-
C-5618	6440	-	-	-	SF 3245	-	-	9300514	-	-
C-5619	-	-	-	-	SF 3842	-	-	52273077	-	-
C-5620	5865	-	RCSF00050	-	SF 2614	-	-	-	305612103A	-
"	5869	-	-	-	SF 5293S	-	-	-	305612103B	-
"	5942	-	-	-	-	-	-	-	30561210512	-
"	-	-	-	-	-	-	-	-	3076121053	-
"	-	-	-	-	-	-	-	-	377612103AH	-
"	-	-	-	-	-	-	-	-	377612103C	-
"	-	-	-	-	-	-	-	-	377612103F	-
"	-	-	-	-	-	-	-	-	377612103J	-
"	-	-	-	-	-	-	-	-	377612105	-
"	-	-	-	-	-	-	-	-	377612105A	-
C-5621	6442	-	RCSF00060	-	SF 3646	-	-	94632228	-	-
C-5622	5644	-	-	-	-	-	-	93235561	-	-
"	5824	-	-	-	-	-	-	-	-	-
C-5623	-	-	RCSF00816	-	-	-	547612907A	-	547612907A	-
C-5624	6444	-	-	-	SF 5099S	-	547612907	-	547612907	-
"	-	-	-	-	SF 5102	-	-	-	-	-
C-5625	5692	-	-	-	SF 5072	7075924	-	-	-	-
C-5626	-	-	-	-	-	9945761	-	-	-	-
"	-	-	-	-	-	9945763	-	-	-	-
"	-	-	-	-	-	9948317	-	-	-	-
C-5628	-	-	RCSF00670	-	-	-	-	-	-	44610-98002
C-5629	5694	-	-	-	SF 2608	7077141	-	-	-	-
"	-	-	-	-	SF 5261	7077392	-	-	-	-
"	-	-	-	-	-	7078822	-	-	-	-
C-5630	-	-	RCSF00654	-	-	-	-	-	-	-
"	-	-	SCSF00211	-	-	-	-	-	-	-
C-5631	5722	2056200063.3	-	-	-	7078631	-	-	-	-
C-5632	5702	0377504400.4	-	PSA412	-	-	-	90297374	-	-
"	-	0377504402.4	-	-	-	-	-	90487038	-	-
C-5633	-	-	RCSF00719	-	-	-	-	-	-	44610-98001C
"	-	-	SCSF00171	-	-	-	-	-	-	-
"	-	-	SCSF00341	-	-	-	-	-	-	-
C-5634	-	-	RCSF00697	-	-	-	-	94625984	-	-
"	-	-	SCSF00198	-	-	-	-	-	-	-
C-5635	6443	-	RCSF00960	PSA437	-	-	1015244	-	-	-
"	-	-	-	-	-	-	1039745	-	-	-
"	-	-	-	-	-	-	96FB2005EF	-	-	-
"	-	-	-	-	-	-	97FU2005AA	-	-	-
"	-	-	-	-	-	-	97FU2005AB	-	-	-
C-5636	5922	2056230075.3	-	-	SF 9388	7079575	-	-	-	-
"	5979	-	-	-	-	7081252	-	-	-	-
C-5637	-	0377505500.4	-	PSA458	-	-	-	-	1H1612107C	-
"	-	0377505502.4	-	-	-	-	-	-	-	-
C-5638	-	-	RCSF00970	PSA338	-	-	-	1035528	-	-
"	-	-	-	-	-	-	97KB2005AE	-	-	-

Servo Freio	Cilindro de Roda – Linha Leve	Reparos de Hydrovac
Cilindro Mestre	Reparos de Cilindro Mestre	Válvula de Retenção de Vácuo
Cilindro de Embreagem	Reparos de Cilindro de Embreagem	Reservatórios de Líquido de Freio
Cilindro de Roda – Linha Pesada	Reparos de Cilindro de Roda Mangueira do Filtro de Ar	Atuadores Concêntricos de Embreagem

CONTROIL	ATE	TEVES - EUROPE	TRW - VARGA	TRW - LUCAS	BOSCH	FIAT	FORD	GM	VW	TOYOTA
"	-	-	-	-	-	-	97KU2005AA	-	-	-
"	-	-	-	-	-	-	97KU2005AB	-	-	-
C-5639	6445	-	-	-	SF 2619	-	-	3495285	-	-
"	-	-	-	-	SF 5470S	-	-	93272855	-	-
C-5640	-	-	-	-	SF 5539	-	91AB2005EB	-	-	-
"	-	-	-	-	-	-	97AG2005EA	-	-	-
C-5641	5953	-	-	-	-	-	-	93289378	-	-
"	5990	-	-	-	-	-	-	-	-	-
C-5642	-	-	-	-	-	-	-	3492871	-	-
C-5643	-	0377506302.4	-	-	-	-	-	-	6K1612107F	-
"	-	-	-	-	-	-	-	-	6K1612107G	-
C-5644	-	-	-	PSA323	-	-	6942039	-	-	-
"	-	-	-	-	-	-	94FB2005AA	-	-	-
C-5645	-	-	RCSF00743	-	-	-	-	52269241	-	-
C-5646	5957	-	-	-	-	-	-	93289336	-	-
C-5647	5938	-	-	-	-	-	-	93272823	-	-
C-5648	-	-	-	-	-	7076986	-	-	-	-
C-5649	6202	-	-	-	-	7081966	-	-	-	-
C-5650	-	-	-	-	SF 5342S	-	-	-	377612103B	-
"	-	-	-	-	-	-	-	-	377612103G	-
C-5651	5868	2056200064.3	-	-	-	7078632	-	-	-	-
C-5652	-	-	-	-	SF 5406S	-	-	-	-	-
C-5653	5923	2056230076.3	-	-	-	7079574	-	-	-	-
"	5981	-	-	-	-	-	-	-	-	-
C-5654	-	0377403000.4	-	-	-	-	-	-	-	-
"	-	0377403002.4	-	-	-	-	-	-	-	-
C-5655	-	0367302800.4	-	PSA220	-	-	-	-	-	-
"	-	0377403102.4	-	-	-	-	-	-	-	-
C-5656	6027	-	-	-	SF 2622	7081979	-	-	-	-
"	6031	-	-	-	-	7082042	-	-	-	-
C-5657	6029	-	-	-	-	7082044	-	-	-	-
"	6033	-	-	-	-	-	-	-	-	-
"	6365	-	-	-	-	-	-	-	-	-
C-5658	-	-	-	-	SF 2613	-	-	-	377612103H	-
"	-	-	-	-	SF 5399S	-	-	-	377612103K	-
C-5659	6221	-	RCSF00980	-	-	-	-	93281897	-	-
C-5660	-	-	RCSF00230	-	-	-	-	93288930	-	-
"	-	-	-	-	-	-	-	93364004	-	-
C-5661	-	-	RCSF01510	-	SF 2833	-	-	-	5X0612105	-
C-5662	-	-	-	-	SF 2621	-	-	-	-	-
C-5664	6065	-	-	-	-	-	-	-	-	-
C-5665	-	-	-	-	SF 2623	-	-	-	-	-
C-5666	-	-	RCSF00260	-	-	-	-	93332849	-	-
C-5667	6162	-	-	-	-	-	2N152005DA	-	-	-
"	6164	-	-	-	-	-	2S652005AA	-	-	-
C-5668	-	-	-	-	-	-	-	93354199	-	-
C-5669	-	-	-	-	-	-	-	-	5U1612105A	-
C-5670	6069	0377506232.4	-	-	-	-	-	-	-	-
C-5672	6475	-	-	-	-	-	-	94736008	-	-
C-5674	-	-	-	-	-	7087525	-	-	-	-
C-9001	-	-	-	-	-	46789771	-	-	-	-
"	-	-	-	-	-	55180198	-	-	-	-
C-9002	-	-	-	-	-	51745868	-	-	-	-

Servo Freio	Cilindro de Roda – Linha Leve	Reparos de Hydrovac
Cilindro Mestre	Reparos de Cilindro Mestre	Válvula de Retenção de Vácuo
Cilindro de Embreagem	Reparos de Cilindro de Embreagem	Reservatórios de Líquido de Freio
Cilindro de Roda – Linha Pesada	Reparos de Cilindro de Roda Mangueira do Filtro de Ar	Atuadores Concêntricos de Embreagem



CONTROL	ATE	TEVES - EUROPE	TRW - VARGA	TRW - LUCAS	BOSCH	FIAT	FORD	GM	VW	TOYOTA
"	-	-	-	-	-	55203232	-	-	-	-
C-9003	-	-	-	-	-	51712916	-	-	-	-
C-9004	-	-	-	-	-	50017371	-	-	-	-
"	-	-	-	-	-	50018001	-	-	-	-
"	-	-	-	-	-	50018278	-	-	-	-
C-9005	-	-	-	-	-	46478774	-	-	-	-
"	-	-	-	-	-	46545700	-	-	-	-
C-9006	-	-	-	-	-	46539451	-	-	-	-
C-9007	-	-	-	-	-	46789769	-	-	-	-
C-9008	-	-	-	-	-	-	-	93396087	-	-
C-9009	-	-	-	-	-	-	-	90411727	-	-
C-9010	-	-	-	-	-	-	-	90466213	-	-
"	-	-	-	-	-	-	-	93335518	-	-
C-9011	-	-	-	-	-	50017372	-	-	-	-
C-9012	-	-	-	-	-	46789766	-	-	-	-
"	-	-	-	-	-	46789767	-	-	-	-
C-9013	-	-	-	-	-	-	-	93240117	-	-
C-9014	-	-	-	-	-	46535628	-	-	-	-
C-9015	-	-	-	-	-	46467381	-	-	-	-
C-9016	-	-	-	-	-	46445723	-	-	-	-
"	-	-	-	-	-	46448515	-	-	-	-
C-9017	-	-	-	-	-	-	-	93397821	-	-
C-9018	-	-	-	-	-	-	-	94701921	-	-
C-9019	-	-	-	-	-	-	-	94701922	-	-
C-9020	-	-	-	-	-	-	-	93362610	-	-
C-9021	-	-	-	-	-	-	-	94733164	-	-
C-9022	-	-	-	-	-	7521503	-	-	-	-
C-9023	-	-	-	-	-	7731108	-	-	-	-
C-9024	-	-	-	-	-	7,524,713	-	-	-	-
C-9025	-	-	-	-	-	50,009,521	-	-	-	-
C-9026	-	-	-	-	-	500.147.69	-	-	-	-
C-9027	-	-	-	-	-	-	-	93251342	-	-
C-9028	-	-	-	-	-	46798703	-	-	-	-
C-9029	-	-	-	-	-	-	-	-	377.129.615.F	-

Servo Freio	Cilindro de Roda – Linha Leve	Reparos de Hydrovac
Cilindro Mestre	Reparos de Cilindro Mestre	Válvula de Retenção de Vácuo
Cilindro de Embreagem	Reparos de Cilindro de Embreagem	Reservatórios de Líquido de Freio
Cilindro de Roda – Linha Pesada	Reparos de Cilindro de Roda Mangueira do Filtro de Ar	Atuadores Concêntricos de Embreagem

## Jogos de Anéis de Vedação do Coletor de Admissão

**C-9501 - JOGO DE ANÉIS DE VEDAÇÃO DO COLETOR DE ADMISSÃO**

	MARCA	VEÍCULO	ANO	SOMENTE PARA
	Fiat	Doblò	2006/...	Motor 1.8 Flex 8V
	Fiat	Ideia	2007/...	Motor 1.8 Flex 8V
	Fiat	Palio	2006/...	Mod. 1.8 R
	Fiat	Palio	2007/...	Motor 1.8 Flex 8V
	Fiat	Palio Weekend	2007/...	Motor 1.8 Flex 8V
	Fiat	Siena	2007/...	Motor 1.8 Flex 8V
	Fiat	Stilo	2006/...	Motor 1.8 Flex 8V
Fiat	Strada	2007/...	Motor 1.8 Flex 8V	

**C-9502 - JOGO DE ANÉIS DE VEDAÇÃO DO COLETOR DE ADMISSÃO**

	MARCA	VEÍCULO	ANO	SOMENTE PARA
	GM	Corsa	2006/...	Motor 1.8 FlexPower 8V
	GM	Meriva	2007/...	Motor 1.8 FlexPower 8V
GM	Montana	2006/2010	Motor 1.8 FlexPower 8V	

**C-9503 - JOGO DE ANÉIS DE VEDAÇÃO DO COLETOR DE ADMISSÃO**

	MARCA	VEÍCULO	ANO	SOMENTE PARA
	Citroën	C3	2002/...	Motor 1.6 16V
	Citroën	C4	2009/...	Motor 1.6 16V
	Peugeot	206	2001/...	Motor 1.6 16V
	Peugeot	206 SW	2005/2008	Motor 1.6 16V
	Peugeot	207	2009/...	Motor 1.6 16V
	Peugeot	207 SW	2009/...	Motor 1.6 16V
Peugeot	307	2001/...	Motor 1.6 16V	

**C-9504 - JOGO DE ANÉIS DE VEDAÇÃO DO COLETOR DE ADMISSÃO**

	MARCA	VEÍCULO	ANO	SOMENTE PARA
	Fiat	Fiorino (mod Uno)	2003/...	Motor 1.3 Fire/Fire Flex 8V
	Fiat	Palio	2001/2004	Motor 1.0/1.3 Fire 8V
	Fiat	Palio	2004/2005	Motor 1.3 Fire Flex 8V
	Fiat	Palio	2006	Motor 1.0 Fire Flex 8V
	Fiat	Palio Weekend	2003/2005	Motor 1.3 Fire/Fire Flex 8V
	Fiat	Siena	2002/2004	Motor 1.0/1.3 Fire 8V
	Fiat	Siena	2005/2005	Motor 1.3 Fire Flex 8V
	Fiat	Siena	2006/...	Motor 1.0 Fire Flex 8V
	Fiat	Strada	2003/2005	Motor 1.3 Fire 8V
Fiat	Uno	2002/...	Motor 1.0/1.3 Fire/Fire Flex 8V	

**C-9505 - JOGO DE ANÉIS DE VEDAÇÃO DO COLETOR DE ADMISSÃO**

	MARCA	VEÍCULO	ANO	SOMENTE PARA
	Fiat	Idea	2006/...	Motor 1.4 Fire/Flex 8V
	Fiat	Palio	2006/...	Motor 1.4 Fire/Flex 8V
	Fiat	Palio Weekend	2006/...	Motor 1.4 Fire/Flex 8V
	Fiat	Siena	2006/...	Motor 1.4 Fire/Flex 8V
Fiat	Strada	2006/...	Motor 1.4 Fire/Flex 8V	

**C-9506 - JOGO DE ANÉIS DE VEDAÇÃO DO COLETOR DE ADMISSÃO**

	MARCA	VEÍCULO	ANO	SOMENTE PARA
	VW	Fox	2004/...	Motor 1.0 Flex 8V
	VW	Gol (ger. III e IV)	2002/2005	Motor 1.0 Gasolina 8V
	VW	Gol (ger. III e IV)	2005/...	Motor 1.0 Flex 8V
VW	Kombi	2006/...	Motor 1.4 Flex 8V	

**C-9507 - JOGO DE ANÉIS DE VEDAÇÃO DO COLETOR DE ADMISSÃO**

	MARCA	VEÍCULO	ANO	SOMENTE PARA
	Fiat	Palio	2004/2006	Motor 1.0 Fire 8V
Fiat	Siena	2004/2006	Motor 1.0 Fire 8V	

**C-9508 - JOGO DE ANÉIS DE VEDAÇÃO DO COLETOR DE ADMISSÃO**

	MARCA	VEÍCULO	ANO	SOMENTE PARA
Peugeot	206	2001/2004	Motor 1.0 16V	

**C-9509 - JOGO DE ANÉIS DE VEDAÇÃO DO COLETOR DE ADMISSÃO**

	MARCA	VEÍCULO	ANO	SOMENTE PARA
	VW	Gol (ger. II)	1997/2000	Motor 1.0 16V
	VW	Gol (ger. III e IV)	2000/2005	Motor 1.0 16V
	VW	Parati (ger. II, III e IV)	1998/2003	Motor 1.0 16V
	VW	Polo	2003/2003	Motor 1.0 16V
VW	Polo Classic	2001/2001	Motor 1.0 16V	

## Mangueiras do Filtro de Ar

GM

## C-9008 - MANGUEIRA DO FILTRO DE AR (sem bocal para sensor)

	REF. ORIGINAL	MARCA	VEÍCULO	ANO	SOMENTE PARA
	93396087	GM	Celta	2003/2008	Motor 1.0/1.6 VHC
		GM	Corsa Classic	2003/2008	
		GM	Prisma	2007/2008	

## C-9009 - MANGUEIRA DO FILTRO DE AR (com bocal para sensor)

	REF. ORIGINAL	MARCA	VEÍCULO	ANO	SOMENTE PARA
	93396087	GM	Celta	2001/2002	
		GM	Corsa	1996/2002	Motor 1.0/1.6 MPFI 8V
		GM	Corsa Classic	2003/2004	Motor 1.0/1.6 MPFI
	GM	Corsa Pick-up	1996/2003	Motor 1.0/1.6 MPFI 8V	

## C-9010 - MANGUEIRA DO FILTRO DE AR (com sensor)

	REF. ORIGINAL	MARCA	VEÍCULO	ANO	SOMENTE PARA
	90466213	GM	Celta	2001/2002	
	93335518	GM	Corsa	1996/2002	Motor 1.0/1.6 MPFI 8V
		GM	Corsa Classic	2003/2004	Motor 1.0/1.6 MPFI
	GM	Corsa Pick-up	1996/2003	Motor 1.0/1.6 MPFI 8V	

## C-9013 - MANGUEIRA DO FILTRO DE AR

	REF. ORIGINAL	MARCA	VEÍCULO	ANO	SOMENTE PARA
	93240117	GM	Vectra	1997/2005	Motor 2.0/2.2 MPFI 8V

## C-9017 - MANGUEIRA DO RESPIRO DO MOTOR

	REF. ORIGINAL	MARCA	VEÍCULO	ANO	SOMENTE PARA
	93397821	GM	Agile	2010/...	
		GM	Celta	2006/...	
		GM	Corsa	2006/...	
		GM	Meriva	2006/...	
		GM	Montana	2006/...	
	GM	Prisma	2007/...		

## C-9018 - MANGUEIRA DO FILTRO DE AR

	REF. ORIGINAL	MARCA	VEÍCULO	ANO	SOMENTE PARA
	94701921	GM	Celta	2009/...	
		GM	Corsa Classic	2009/...	
	GM	Prisma	2009/...	Motor 1.0	

## C-9019 - MANGUEIRA DO FILTRO DO MOTOR

	REF. ORIGINAL	MARCA	VEÍCULO	ANO	SOMENTE PARA
	94701922	GM	Prisma	2009/...	Motor 1.4

## C-9020 - MANGUEIRA DA TOMADA DE AR

	REF. ORIGINAL	MARCA	VEÍCULO	ANO	SOMENTE PARA
	93362610	GM	Corsa	2002/...	
		GM	Montana	2004/2010	

## C-9021 - MANGUEIRA DA TOMADA DE AR

	REF. ORIGINAL	MARCA	VEÍCULO	ANO	SOMENTE PARA
	94733164	GM - CHEVROLET	COBALT	2012/...	
		GM - CHEVROLET	COBALT	2012/...	
		GM - CHEVROLET	SPIN	2013/...	
	GM - CHEVROLET	SPIN	2013/...		

## Mangueiras do Filtro de Ar



### C-9027 - MANGUEIRA DA TOMADA DE AR

	REF. ORIGINAL	MARCA	VEÍCULO	ANO	SOMENTE PARA
	93251342	GM - CHEVROLET	BLAZER	1998/2000	2.2 MPFI
		GM - CHEVROLET	BLAZER	1998/2000	2.2 MPFI
		GM - CHEVROLET	S-10	1998/2000	2.2 MPFI
		GM - CHEVROLET	S-10	1998/2000	2.2 MPFI



### C-9001 - MANGUEIRA DO FILTRO DE AR

	REF. ORIGINAL	MARCA	VEÍCULO	ANO	SOMENTE PARA
	93397821	Fiat	Palio	2001/2004	Motor 1.0 Fire 8V
		Fiat	Palio	2003/2006	Motor 1.3 Fire 8V
		Fiat	Palio	2006/...	Motor 1.0 Fire 8V (Flex)
		Fiat	Palio Weekend	2003/2005	Motor 1.3 Fire 8V
		Fiat	Siena	2002/2003	Motor 1.0 Fire 8V
		Fiat	Siena	2003/2005	Motor 1.3 Fire 8V
		Fiat	Siena	2006/...	Motor 1.0 Fire 8V (Flex)
		Fiat	Strada	2003/2005	Motor 1.3 Fire 8V
		Fiat	Uno	2006/2006	Motor 1.0 Fire 8V (Flex)

### C-9002 - MANGUEIRA DO FILTRO DE AR

	REF. ORIGINAL	MARCA	VEÍCULO	ANO	SOMENTE PARA
	51745868	Fiat	Idea	2006/...	Motor 1.4 Fire 8V (Flex)
	55203232	Fiat	Palio	2006/...	Motor 1.4 Fire 8V (Flex)
		Fiat	Palio Weekend	2006/...	Motor 1.4 Fire 8V (Flex)
		Fiat	Siena	2006/...	Motor 1.4 Fire 8V (Flex)

### C-9003 - MANGUEIRA DO FILTRO DE AR

	REF. ORIGINAL	MARCA	VEÍCULO	ANO	SOMENTE PARA
	51712916	Fiat	Palio	2004/2006	Motor 1.0 Fire 8V
	Fiat	Siena	2004/2006	Motor 1.0 Fire 8V	

### C-9004 - MANGUEIRA DO FILTRO DE AR

	REF. ORIGINAL	MARCA	VEÍCULO	ANO	SOMENTE PARA
	50018001	Fiat	Fiorino (mo.d Uno)	2003/2007	Motor 1.3 Fire 8V
	50017371	Fiat	Uno	2004/...	Motor 1.3 MPI 8V
50018278	Fiat	Uno	2002/2006	Motor 1.0 Fire 8V	

### C-9005 - MANGUEIRA DO FILTRO DE AR

	REF. ORIGINAL	MARCA	VEÍCULO	ANO	SOMENTE PARA
	46478774	Fiat	Palio	1998/2000	Motor 1.6 8V
	46545700	Fiat	Palio Weekend	1999/2000	Motor 1.6 8V
		Fiat	Siena	1998/2000	Motor 1.6 8V
	Fiat	Strada	1999/2000	Motor 1.6 8V	

### C-9006 - MANGUEIRA DO FILTRO DE AR

	REF. ORIGINAL	MARCA	VEÍCULO	ANO	SOMENTE PARA
	46539451	Fiat	Palio	1996/2000	Motor 1.6 16V
		Fiat	Palio Weekend	1997/2000	Motor 1.6 16V
		Fiat	Siena	1998/1999	Motor 1.6 16V
	Fiat	Strada	1999/2001	Motor 1.6 16V	

### C-9007 - MANGUEIRA DO FILTRO DE AR

	REF. ORIGINAL	MARCA	VEÍCULO	ANO	SOMENTE PARA
	46789769	Fiat	Palio	2001/2003	Motor 1.0/1.3 Fire 16V
		Fiat	Palio Weekend	2001/2003	Motor 1.0/1.3 Fire 16V
	Fiat	Siena	2001/2003	Motor 1.0/1.3 Fire 16V	

## Mangueiras do Filtro de Ar



### C-9011 - MANGUEIRA DO FILTRO DE AR

	REF. ORIGINAL	MARCA	VEÍCULO	ANO	SOMENTE PARA
	50017372	Fiat	Fiorino (mod. Uno)	2003/...	Motor 1.3 Fire 8V (Flex)
		Fiat	Palio	2003/...	Motor 1.0/1.3 Fire 8V (Flex)
		Fiat	Palio Weekend	2003/2005	Motor 1.3 Fire 8V (Flex)
		Fiat	Siena	2003/...	Motor 1.0/1.3 Fire 8V (Flex)
		Fiat	Strada	2003/2005	Motor 1.3 Fire 8V (Flex)
		Fiat	uno	2002/...	Motor 1.0/1.3 Fire 8V (Flex)

### C-9012 - MANGUEIRA DO FILTRO DE AR

	REF. ORIGINAL	MARCA	VEÍCULO	ANO	SOMENTE PARA
	46789767	Fiat	Palio	2001/2003	Motor 1.0/1.3 Fire 16V
	46789766	Fiat	Palio Weekend	2001/2003	Motor 1.0/1.3 Fire 16V
		Fiat	Siena	2001/2003	Motor 1.0/1.3 Fire 16V

### C-9014 - MANGUEIRA DO FILTRO DE AR

	REF. ORIGINAL	MARCA	VEÍCULO	ANO	SOMENTE PARA
	46535628	Fiat	Palio	1996/2004	Motor 1.5 (saída maior)
		Fiat	Palio Weekend	1997/2004	Motor 1.5 (saída maior)
		Fiat	Siena	1998/2004	Motor 1.5 (saída maior)
		Fiat	STRADA	1999/2004	Motor 1.5 (saída maior)

### C-9015 - MANGUEIRA DO FILTRO DE AR

	REF. ORIGINAL	MARCA	VEÍCULO	ANO	SOMENTE PARA
	46467381	Fiat	Palio	1996/2004	Motor 1.5 (saída menor)
		Fiat	Palio Weekend	1997/2004	Motor 1.5 (saída menor)
		Fiat	Siena	1998/2004	Motor 1.5 (saída menor)
		Fiat	Strada	1999/2004	Motor 1.5 (saída menor)

### C-9016 - MANGUEIRA DO FILTRO DE AR

	REF. ORIGINAL	MARCA	VEÍCULO	ANO	SOMENTE PARA
	46445723	Fiat	Palio	1996/2000	Motor 1.0
	46448515				

### C-9022 - MANGUERA DEL RESPIRADERO DEL MOTOR - BLOW-BY HOSE

	REF. ORIGINAL	MARCA	VEÍCULO	ANO	SOMENTE PARA
	7521503	FIAT	PALIO	1996/2002	
		FIAT	PALIO	1996/2002	
		FIAT	PALIO	1996/2002	
		FIAT	PALIO	1996/2002	
		FIAT	PALIO WEEKEND	1996/2000	
		FIAT	PALIO WEEKEND	1996/2000	
		FIAT	SIENA	1996/2000	
		FIAT	SIENA	1996/2000	
		FIAT	STRADA	1996/2000	
		FIAT	STRADA	1996/2000	

### C-9023 - MANGUEIRA RESPIRO MOTOR

	REF. ORIGINAL	MARCA	VEÍCULO	ANO	SOMENTE PARA
	7731108	FIAT	FIORINO	1985/2004	(mod. Uno)
		FIAT	FIORINO	1985/2004	(mod. Uno)
		FIAT	UNO	1985/2004	
		FIAT	UNO	1985/2004	

## Mangueiras do Filtro de Ar



### C-9024 - MANGUEIRA DO FILTRO DE AR

	REF. ORIGINAL	MARCA	VEÍCULO	ANO	SOMENTE PARA
		7.524.713	FIAT	ELBA	1991/1996
		FIAT	ELBA	1991/1996	
		FIAT	FIORINO	1989/1996	(mod. Uno)
		FIAT	FIORINO	1989/1996	(mod. Uno)
		FIAT	FIORINO	1996/...	(mod. Uno)1.0
		FIAT	FIORINO	1996/...	(mod. Uno)1.0
		FIAT	PRÊMIO	1991/1994	
		FIAT	PRÊMIO	1991/1994	
		FIAT	UNO	1991/1993	MILLE
		FIAT	UNO	1991/1993	MILLE
		FIAT	UNO	1991/1996	
		FIAT	UNO	1991/1996	
		FIAT	UNO	1996/2000	MILLE SPI
		FIAT	UNO	1996/2000	MILLE SPI
		FIAT	UNO	2000/2001	SMART
		FIAT	UNO	2000/2001	SMART

### C-9026 - MANGUEIRA DO FILTRO DE AR

	REF. ORIGINAL	MARCA	VEÍCULO	ANO	SOMENTE PARA
		500.147.69	FIAT	FIORINO	1992/2004
		FIAT	FIORINO	1992/2004	1.5 8V BOCAL MAIOR PARA SENSOR
		FIAT	FIORINO	2003/2004	BOCAL MAIORPARA SENSOR
		FIAT	FIORINO	2003/2004	BOCAL MAIORPARA SENSOR
		FIAT	PALIO	2001/2003	1.3 8V BOCAL MENOR PARA SENSOR
		FIAT	PALIO	2001/2003	1.3 8V BOCAL MENOR PARA SENSOR
		FIAT	UNO	1997/2004	FURGÃO / BOCAL MAIOR PARA SENSOR
		FIAT	UNO	1997/2004	FURGÃO / BOCAL MAIOR PARA SENSOR
		FIAT	UNO	2001/2003	BOCAL MAIOR PARA SENSOR
		FIAT	UNO	2001/2003	BOCAL MAIOR PARA SENSOR

### C-9028 - MANGUEIRA DO FILTRO DE AR

	REF. ORIGINAL	MARCA	VEÍCULO	ANO	SOMENTE PARA
		46798703	FIAT	PALIO	2001/2003
		FIAT	PALIO	2001/2003	1.6 16V
		FIAT	PALIO WEEKEND	2001/2003	1.6 16V
		FIAT	PALIO WEEKEND	2001/2003	1.6 16V
		FIAT	SIENA	2001/2003	1.6 16V
		FIAT	SIENA	2001/2003	1.6 16V
		FIAT	STRADA	1999/2001	1.6 16V
		FIAT	STRADA	1999/2001	1.6 16V



### C-9030 - MANGUEIRA DO FILTRO DE AR

	REF. ORIGINAL	MARCA	VEÍCULO	ANO	SOMENTE PARA
		CD150150	MITSUBISHI	ASX	.../2011
		MITSUBISHI	ASX	.../2011	
		MITSUBISHI	LANCER	2012/...	
		MITSUBISHI	LANCER	2012/...	

### C-9031 - MANGUEIRA DO FILTRO DE AR

	REF. ORIGINAL	MARCA	VEÍCULO	ANO	SOMENTE PARA
			MITSUBISHI	PAJERO/TR4	2003/...
		MITSUBISHI	PAJERO/TR4	2003/...	

Mangueiras do Filtro de Ar



C-9029- MANGUEIRA DO FILTRO DE AR					
REF. ORIGINAL	MARCA	VEÍCULO	ANO	SOMENTE PARA	
	377.129.615.F	VOLKSWAGEN	GOL (G2)	1994/...	AP MI
		VOLKSWAGEN	GOL (G2)	1994/...	AP MI
		VOLKSWAGEN	GOL (G3)	1994/...	AP MI
		VOLKSWAGEN	GOL (G3)	1994/...	AP MI
		VOLKSWAGEN	GOL (G4)	1994/...	AP MI
		VOLKSWAGEN	GOL (G4)	1994/...	AP MI
		VOLKSWAGEN	PARATI (G2, G3 e G4)	1994/...	AP MI
		VOLKSWAGEN	PARATI (G2, G3 e G4)	1994/...	AP MI
		VOLKSWAGEN	SAVEIRO (G2, G3 e G4)	1994/...	AP MI
		VOLKSWAGEN	SAVEIRO (G2, G3 e G4)	1994/...	AP MI

NOTAS:

---

---

---

---

---

---

---

---

---

---

---

---

---

---

---

---

---

---

---

---

---

---

---

---

---

---

---

---

---

---





---

# BUSCA POR VEÍCULO

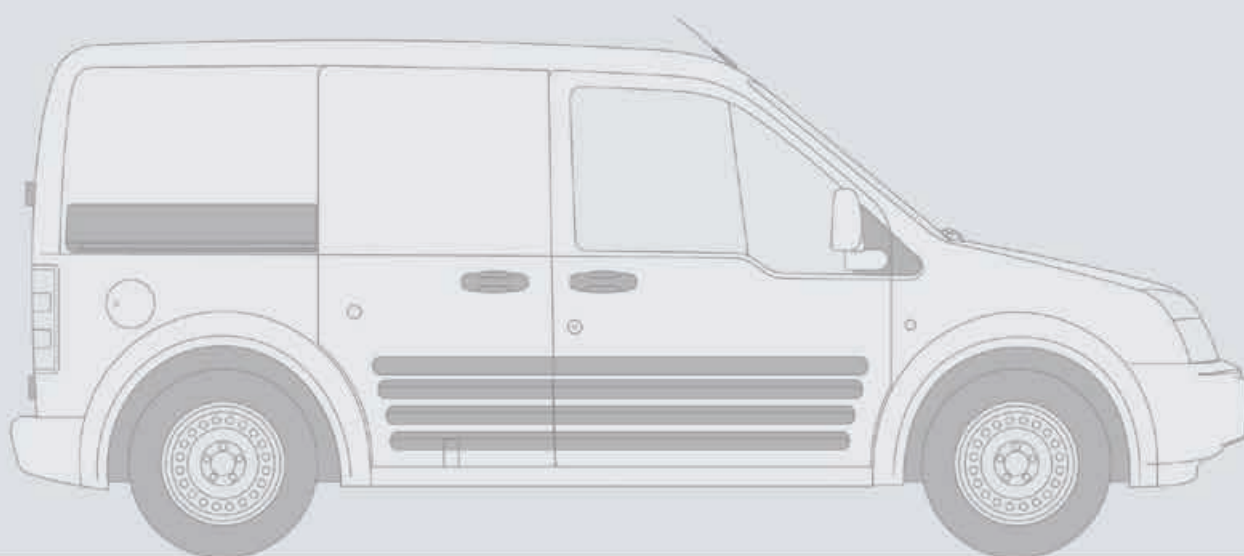

VEÍCULO		DESCRIÇÃO	ANOS	OBSERVAÇÃO	REF.	IMAGEM
<b>AGRALE</b>						
1100 D		REPARO DO CILINDRO MESTRE SIMPLES 25,40mm	1982/1983		C-1013	
1100 D	<-	REPARO DO CILINDRO DE RODA 28,57mm	1982/1983		C-1422	
1100 D	<-	COPO DO CILINDRO DE RODA 28,57mm	1982/1983		CO-1309	
1100 D	<-	TAPA-PÓ DO CILINDRO DE RODA	1982/1983		TA-0349	
1100 D	->	REPARO DO CILINDRO DE RODA 23,81mm	1982/1983		C-1405	
1100 D	->	COPO DO CILINDRO DE RODA 23,81mm	1982/1983		CO-1311	
1100 D	->	TAPA-PÓ DO CILINDRO DE RODA	1982/1983		TA-0314	
1200 A		REPARO DO CILINDRO MESTRE SIMPLES 25,40mm	1983/1985		C-1013	
1200 A	<-	REPARO DO CILINDRO DE RODA 28,57mm	1983/1985		C-1422	
1200 A	<-	COPO DO CILINDRO DE RODA 28,57mm	1983/1985		CO-1309	
1200 A	<-	TAPA-PÓ DO CILINDRO DE RODA	1983/1985		TA-0349	
1200 A	->	REPARO DO CILINDRO DE RODA 23,81mm	1983/1985		C-1405	
1200 A	->	COPO DO CILINDRO DE RODA 23,81mm	1983/1985		CO-1311	
1200 A	->	TAPA-PÓ DO CILINDRO DE RODA	1983/1985		TA-0314	
1600 A/D RS/RD		SERVO FREIO 200mm	1986/1989		C-5621	
1600 A/D RS/RD		VÁLVULA DE RETENÇÃO DE VÁCUO	1986/1989		C-1755	
1600 A/D RS/RD		CILINDRO MESTRE DUPL0 25,40mm	1986/1989		C-2054	
1600 A/D RS/RD		CILINDRO MESTRE DUPL0 28,57mm	1990/1996		C-2044	
1600 A/D RS/RD		REPARO DO CILINDRO MESTRE SIMPLES 25,40mm	1983/1985		C-1013	
1600 A/D RS/RD		REPARO DO CILINDRO MESTRE DUPL0 25,40mm	1986/1989		C-1092	
1600 A/D RS/RD		REPARO DO CILINDRO MESTRE DUPL0 28,57mm	1990/1996		C-1114	
1600 A/D RS/RD		RESERVATÓRIO C/ TAMPA	1986/1987		C-0105	
1600 A/D RS/RD		RESERVATÓRIO C/ TAMPA E AVISO DE NÍVEL	1988/1996		C-0109	
1600 A/D RS/RD		VEDANTE DO CILINDRO MESTRE	1986/1996		VE-0203	
1600 A/D RS/RD	<-	CILINDRO DE RODA ESQUERDA 28,57mm	1983/1989		C-3307	
1600 A/D RS/RD	<-	CILINDRO DE RODA DIREITA 28,57mm	1983/1989		C-3308	
1600 A/D RS/RD	<-	REPARO DO CILINDRO DE RODA 28,57mm	1983/1989		C-1422	
1600 A/D RS/RD	<-	COPO DO CILINDRO DE RODA 28,57mm	1983/1989		CO-1309	
1600 A/D RS/RD	<-	TAPA-PÓ DO CILINDRO DE RODA	1983/1989		TA-0349	
1600 A/D RS/RD	<-	REPARO DE VEDAÇÃO DA PINÇA 76,00mm	1990/1996		C-1528	
1600 A/D RS/RD	->	CILINDRO DE RODA ESQUERDA 23,81mm	1990/1996		C-3305	

Tabela de Conversão	Polegadas	9/16"	5/8"	11/16"	7/10"	3/4"	13/16"	7/8"	15/16"	1"	1 1/16"	1 1/8"	1 1/4"	1 3/8"	1 1/2"	1 5/8"	1 3/4"	1 27/32"	2"
	Milímetros	14,28mm	15,87mm	17,46mm	17,78mm	19,05mm	20,63mm	22,22mm	23,81mm	25,40mm	26,98mm	28,57mm	31,75mm	34,92mm	38,10mm	41,27mm	44,45mm	46,83mm	50,80mm

VEÍCULO		DESCRIÇÃO	ANOS	OBSERVAÇÃO	REF.	IMAGEM
<b>AGRALE</b>						
1600 A/D RS/RD	->	CILINDRO DE RODA DIREITA 23,81mm	1990/1996		C-3306	
1600 A/D RS/RD	->	REPARO DO CILINDRO DE RODA 23,81mm	1990/1996		C-1405	
1600 A/D RS/RD	->	COPO DO CILINDRO DE RODA 23,81mm	1983/1996		CO-1311	
1600 A/D RS/RD	->	TAPA-PÓ DO CILINDRO DE RODA	1983/1996		TA-0314	
1800 D RS/RD		SERVO FREIO 200mm	1988/1989		C-5621	
1800 D RS/RD		VÁLVULA DE RETENÇÃO DE VÁCUO	1988/1989		C-1755	
1800 D RS/RD		CILINDRO MESTRE DUPLO 25,40mm	1988/1989		C-2054	
1800 D RS/RD		CILINDRO MESTRE DUPLO 28,57mm	1990/1996		C-2044	
1800 D RS/RD		REPARO DO CILINDRO MESTRE DUPLO 25,40mm	1988/1989		C-1092	
1800 D RS/RD		REPARO DO CILINDRO MESTRE DUPLO 28,57mm	1990/1996		C-1114	
1800 D RS/RD		RESERVATÓRIO C/ TAMPÃO E AVISO DE NÍVEL	1988/1996		C-0109	
1800 D RS/RD		VEDANTE DO CILINDRO MESTRE	1988/1996		VE-0203	
1800 D RS/RD	<-	CILINDRO DE RODA ESQUERDA 28,57mm	1988/1989		C-3307	
1800 D RS/RD	<-	CILINDRO DE RODA DIREITA 28,57mm	1988/1989		C-3308	
1800 D RS/RD	<-	REPARO DO CILINDRO DE RODA 28,57mm	1988/1989		C-1422	
1800 D RS/RD	<-	COPO DO CILINDRO DE RODA 28,57mm	1988/1989		CO-1309	
1800 D RS/RD	<-	TAPA-PÓ DO CILINDRO DE RODA	1988/1989		TA-0349	
1800 D RS/RD	<-	REPARO DE VEDAÇÃO DA PINÇA 76,00mm	1990/1996		C-1528	
1800 D RS/RD	->	CILINDRO DE RODA ESQUERDA 23,81mm	1990/1996		C-3305	
1800 D RS/RD	->	CILINDRO DE RODA DIREITA 23,81mm	1990/1996		C-3306	
1800 D RS/RD	->	REPARO DO CILINDRO DE RODA 23,81mm	1988/1996		C-1405	
1800 D RS/RD	->	COPO DO CILINDRO DE RODA 23,81mm	1988/1996		CO-1311	
1800 D RS/RD	->	TAPA-PÓ DO CILINDRO DE RODA	1988/1996		TA-0314	

BUSCA POR VEÍCULOS

Tabela de Conversão	Polegadas	9/16"	5/8"	11/16"	7/10"	3/4"	13/16"	7/8"	15/16"	1"	1 1/16"	1 1/8"	1 1/4"	1 3/8"	1 1/2"	1 5/8"	1 3/4"	1 27/32"	2"
	Milímetros	14,28mm	15,87mm	17,46mm	17,78mm	19,05mm	20,63mm	22,22mm	23,81mm	25,40mm	26,98mm	28,57mm	31,75mm	34,92mm	38,10mm	41,27mm	44,45mm	46,83mm	50,80mm















VEÍCULO		DESCRIÇÃO	ANOS	OBSERVAÇÃO	REF.	IMAGEM
<b>AGRALE</b>						
4500/5000		CILINDRO MESTRE DE EMBREAGEM 22,22mm	1994/1998		C-2605	
4500/5000		CILINDRO AUXILIAR DE EMBREAGEM 22,22mm	1994/1998		C-2613	
4500/5000		REPARO DO CIL. MESTRE DE EMBREAGEM 22,22mm	1994/1998		C-1631	
4500/5000		REPARO DO CIL. AUXILIAR DE EMBREAGEM 22,22mm	1994/1998		C-1630	
6000		CILINDRO MESTRE DE EMBREAGEM 22,22mm	1999/...		C-2605	
6000		CILINDRO AUXILIAR DE EMBREAGEM 22,22mm	1999/...		C-2613	
6000		REPARO DO CIL. MESTRE DE EMBREAGEM 22,22mm	1999/...		C-1631	
6000		REPARO DO CIL. AUXILIAR DE EMBREAGEM 22,22mm	1999/...		C-1630	
7000/7500		CILINDRO MESTRE DE EMBREAGEM 22,22mm	1993/2005		C-2605	
7000/7500		CILINDRO AUXILIAR DE EMBREAGEM 22,22mm	1993/2005		C-2613	
7000/7500		REPARO DO CIL. MESTRE DE EMBREAGEM 22,22mm	1993/2005		C-1631	
7000/7500		REPARO DO CIL. AUXILIAR DE EMBREAGEM 22,22mm	1993/2005		C-1630	
8500		CILINDRO MESTRE DE EMBREAGEM 22,22mm	1997/...		C-2605	
8500		CILINDRO AUXILIAR DE EMBREAGEM 22,22mm	1997/...		C-2613	
8500		REPARO DO CIL. MESTRE DE EMBREAGEM 22,22mm	1997/...		C-1631	
8500		REPARO DO CIL. AUXILIAR DE EMBREAGEM 22,22mm	1997/...		C-1630	
9200 TCA		CILINDRO MESTRE DE EMBREAGEM 22,22mm	2003/...		C-2605	

Tabela de Conversão	Polegadas	9/16"	5/8"	11/16"	7/10"	3/4"	13/16"	7/8"	15/16"	1"	1 1/16"	1 1/8"	1 1/4"	1 3/8"	1 1/2"	1 5/8"	1 3/4"	1 27/32"	2"
	Milímetros	14,28mm	15,87mm	17,46mm	17,78mm	19,05mm	20,63mm	22,22mm	23,81mm	25,40mm	26,98mm	28,57mm	31,75mm	34,92mm	38,10mm	41,27mm	44,45mm	46,83mm	50,80mm

VEÍCULO		DESCRIÇÃO	ANOS	OBSERVAÇÃO	REF.	IMAGEM
<b>AGRALE</b>						
9200 TCA		CILINDRO AUXILIAR DE EMBREAGEM 22,22mm	2003/...		C-2613	
9200 TCA		REPARO DO CIL. MESTRE DE EMBREAGEM 22,22mm	2003/...		C-1631	
9200 TCA		REPARO DO CIL. AUXILIAR DE EMBREAGEM 22,22mm	2003/...		C-1630	
FURGOVAN		CILINDRO MESTRE DE EMBREAGEM 22,22mm	2002/...		C-2605	
FURGOVAN		CILINDRO MESTRE DE EMBREAGEM 23,81mm	2004/...	MOTOR ELETRÔNICO	C-2639	
FURGOVAN		CILINDRO AUXILIAR DE EMBREAGEM 22,22mm	2002/...		C-2613	
FURGOVAN		REPARO DO CIL. MESTRE DE EMBREAGEM 22,22mm	2002/...		C-1631	
FURGOVAN		REPARO DO CIL. MESTRE DE EMBREAGEM 23,81mm	2004/...	MOTOR ELETRÔNICO	C-1639	
FURGOVAN		REPARO DO CIL. AUXILIAR DE EMBREAGEM 22,22mm	2002/...		C-1630	
MA 5.0/6.0/7.5/8.0/8.5/9.2		CILINDRO MESTRE DE EMBREAGEM 22,22mm	1996/...		C-2605	
MA 5.0/6.0/7.5/8.0/8.5/9.2		CILINDRO MESTRE DE EMBREAGEM 23,81mm	2004/...	MOTOR ELETRÔNICO	C-2639	
MA 5.0/6.0/7.5/8.0/8.5/9.2		CILINDRO AUXILIAR DE EMBREAGEM 22,22mm	1996/...		C-2613	
MA 5.0/6.0/7.5/8.0/8.5/9.2		REPARO DO CIL. MESTRE DE EMBREAGEM 22,22mm	1996/...		C-1631	
MA 5.0/6.0/7.5/8.0/8.5/9.2		REPARO DO CIL. MESTRE DE EMBREAGEM 23,81mm	2004/...	MOTOR ELETRÔNICO	C-1639	
MA 5.0/6.0/7.5/8.0/8.5/9.2		REPARO DO CIL. AUXILIAR DE EMBREAGEM 22,22mm	1996/...		C-1630	
MA 12.0		CILINDRO MESTRE DE EMBREAGEM 20,63mm	2004/...		C-2621	
MA 12.0		REPARO DO CIL. MESTRE DE EMBREAGEM 20,63mm	2004/...		C-1624	
MARRUÁ		REPARO DO CIL. MESTRE DE EMBREAGEM 23,81mm	2005/...		C-1639	
MARRUÁ	<	REPARO DE VEDAÇÃO DA PINÇA 46,00mm	2005/...		C-1592	
VOLARE A5/V5		CILINDRO MESTRE DE EMBREAGEM 22,22mm	2002/2004		C-2605	

BUSCA POR VEÍCULOS

Tabela de Conversão	Polegadas	9/16"	5/8"	11/16"	7/10"	3/4"	13/16"	7/8"	15/16"	1"	1 1/16"	1 1/8"	1 1/4"	1 3/8"	1 1/2"	1 5/8"	1 3/4"	1 27/32"	2"
	Milímetros	14,28mm	15,87mm	17,46mm	17,78mm	19,05mm	20,63mm	22,22mm	23,81mm	25,40mm	26,98mm	28,57mm	31,75mm	34,92mm	38,10mm	41,27mm	44,45mm	46,83mm	50,80mm

VEÍCULO		DESCRIÇÃO	ANOS	OBSERVAÇÃO	REF.	IMAGEM
<b>AGRALE</b>						
VOLARE A5/V5		CILINDRO MESTRE DE EMBREAGEM 23,81mm	2005/2007		C-2639	
VOLARE A5/V5		CILINDRO MESTRE DE EMBREAGEM 23,81mm	2008/...		C-2670	
VOLARE A5/V5		CILINDRO AUXILIAR DE EMBREAGEM 22,22mm	2002/2007		C-2613	
VOLARE A5/V5		CILINDRO AUXILIAR DE EMBREAGEM 25,40mm	2008/...		C-2653	
VOLARE A5/V5		REPARO DO CIL. MESTRE DE EMBREAGEM 22,22mm	2002/2004		C-1631	
VOLARE A5/V5		REPARO DO CIL. MESTRE DE EMBREAGEM 23,81mm	2005/2007		C-1639	
VOLARE A5/V5		REPARO DO CIL. AUXILIAR DE EMBREAGEM 22,22mm	2002/2007		C-1630	
VOLARE A5/V5		CILINDRO MESTRE DUPLA 28,57mm	2002/...		C-2044	
VOLARE A5/V5		REPARO DO CILINDRO MESTRE DUPLA 28,57mm	2002/...		C-1114	
VOLARE A5/V5		RESERVATÓRIO C/ TAMPÃO E AVISO DE NÍVEL	2002/...		C-0109	
VOLARE A5/V5		VEDANTE DO CILINDRO MESTRE	2002/...		VE-0203	
VOLARE A5/V5	<-	REPARO DE VEDAÇÃO DA PINÇA 76,00mm	2002/...		C-1528	
VOLARE A5/V5	->	CILINDRO DE RODA ESQUERDA 23,81mm	2002/...		C-3305	
VOLARE A5/V5	->	CILINDRO DE RODA DIREITA 23,81mm	2002/...		C-3306	
VOLARE A5/V5	->	REPARO DO CILINDRO DE RODA 23,81mm	2002/...		C-1405	
VOLARE A5/V5	->	COPO DO CILINDRO DE RODA 23,81mm	2002/...		CO-1311	
VOLARE A5/V5	->	TAPA-PÓ DO CILINDRO DE RODA	2002/...		TA-0314	
VOLARE A6/V6		CILINDRO MESTRE DE EMBREAGEM 22,22mm	1998/2004		C-2605	
VOLARE A6/V6		CILINDRO MESTRE DE EMBREAGEM 23,81mm	2005/2007		C-2639	

Tabela de Conversão	Polegadas	9/16"	5/8"	11/16"	7/10"	3/4"	13/16"	7/8"	15/16"	1"	1 1/16"	1 1/8"	1 1/4"	1 3/8"	1 1/2"	1 5/8"	1 3/4"	1 27/32"	2"
	Milímetros	14,28mm	15,87mm	17,46mm	17,78mm	19,05mm	20,63mm	22,22mm	23,81mm	25,40mm	26,98mm	28,57mm	31,75mm	34,92mm	38,10mm	41,27mm	44,45mm	46,83mm	50,80mm

VEÍCULO		DESCRIÇÃO	ANOS	OBSERVAÇÃO	REF.	IMAGEM
<b>AGRALE</b>						
VOLARE A6/V6		CILINDRO MESTRE DE EMBREAGEM 23,81mm	2008/...		C-2670	
VOLARE A6/V6		CILINDRO AUXILIAR DE EMBREAGEM 22,22mm	1998/2007		C-2613	
VOLARE A6/V6		CILINDRO AUXILIAR DE EMBREAGEM 25,40mm	2008/...		C-2653	
VOLARE A6/V6		REPARO DO CIL. MESTRE DE EMBREAGEM 22,22mm	1998/2004		C-1631	
VOLARE A6/V6		REPARO DO CIL. MESTRE DE EMBREAGEM 23,81mm	2005/2007		C-1639	
VOLARE A6/V6		REPARO DO CIL. AUXILIAR DE EMBREAGEM 22,22mm	1998/2007		C-1630	
VOLARE A6/V6		CILINDRO MESTRE DUPLO 28,57mm	1998/...		C-2044	
VOLARE A6/V6		REPARO DO CILINDRO MESTRE DUPLO 28,57mm	1998/...		C-1114	
VOLARE A6/V6		RESERVATÓRIO C/ TAMP A E AVISO DE NÍVEL	1998/...		C-0109	
VOLARE A6/V6		VEDANTE DO CILINDRO MESTRE	1998/...		VE-0203	
VOLARE A6/V6	<-	REPARO DE VEDAÇÃO DA PINÇA 76,00mm	1998/...		C-1528	
VOLARE A6/V6	->	CILINDRO DE RODA ESQUERDA 23,81mm	1998/...		C-3305	
VOLARE A6/V6	->	CILINDRO DE RODA DIREITA 23,81mm	1998/...		C-3306	
VOLARE A6/V6	->	REPARO DO CILINDRO DE RODA 23,81mm	1998/...		C-1405	
VOLARE A6/V6	->	COPO DO CILINDRO DE RODA 23,81mm	1998/...		CO-1311	
VOLARE A6/V6	->	TAPA-PÓ DO CILINDRO DE RODA	1998/...		TA-0314	
VOLARE A8/V8		CILINDRO MESTRE DE EMBREAGEM 22,22mm	2000/2004		C-2605	
VOLARE A8/V8		CILINDRO MESTRE DE EMBREAGEM 23,81mm	2005/2007		C-2639	
VOLARE A8/V8		CILINDRO MESTRE DE EMBREAGEM 23,81mm	2008/...		C-2670	

BUSCA POR VEÍCULOS

Tabela de Conversão	Polegadas	9/16"	5/8"	11/16"	7/10"	3/4"	13/16"	7/8"	15/16"	1"	1 1/16"	1 1/8"	1 1/4"	1 3/8"	1 1/2"	1 5/8"	1 3/4"	1 27/32"	2"
	Milímetros	14,28mm	15,87mm	17,46mm	17,78mm	19,05mm	20,63mm	22,22mm	23,81mm	25,40mm	26,98mm	28,57mm	31,75mm	34,92mm	38,10mm	41,27mm	44,45mm	46,83mm	50,80mm













VEÍCULO		DESCRIÇÃO	ANOS	OBSERVAÇÃO	REF.	IMAGEM
<b>AGRALE</b>						
VOLARE A8/V8		CILINDRO AUXILIAR DE EMBREAGEM 22,22mm	2000/2004		C-2613	
VOLARE A8/V8		CILINDRO AUXILIAR DE EMBREAGEM 25,40mm	2008/...		C-2653	
VOLARE A8/V8		REPARO DO CIL. MESTRE DE EMBREAGEM 23,81mm	2000/2007		C-1639	
VOLARE A8/V8		REPARO DO CIL. AUXILIAR DE EMBREAGEM 22,22mm	2000/2007		C-1630	
VOLARE W8		CILINDRO MESTRE DE EMBREAGEM 22,22mm	2002/2004		C-2605	
VOLARE W8		CILINDRO MESTRE DE EMBREAGEM 23,81mm	2005/2007		C-2639	
VOLARE W8		CILINDRO MESTRE DE EMBREAGEM 23,81mm	2008/...		C-2670	
VOLARE W8		CILINDRO AUXILIAR DE EMBREAGEM 22,22mm	2002/2007		C-2613	
VOLARE W8		CILINDRO AUXILIAR DE EMBREAGEM 25,40mm	2008/...		C-2653	
VOLARE W8		REPARO DO CIL. MESTRE DE EMBREAGEM 22,22mm	2002/2004		C-1631	
VOLARE W8		REPARO DO CIL. MESTRE DE EMBREAGEM 23,81mm	2005/2007		C-1639	
VOLARE W8		REPARO DO CIL. AUXILIAR DE EMBREAGEM 22,22mm	2002/2007		C-1630	
VOLARE W9		CILINDRO MESTRE DE EMBREAGEM 23,81mm	2006/2007		C-2639	
VOLARE W9		CILINDRO MESTRE DE EMBREAGEM 23,81mm	2008/...		C-2670	
VOLARE W9		CILINDRO AUXILIAR DE EMBREAGEM 22,22mm	2006/2007		C-2613	

Tabela de Conversão	Polegadas	9/16"	5/8"	11/16"	7/10"	3/4"	13/16"	7/8"	15/16"	1"	1 1/16"	1 1/8"	1 1/4"	1 3/8"	1 1/2"	1 5/8"	1 3/4"	1 27/32"	2"
	Milímetros	14,28mm	15,87mm	17,46mm	17,78mm	19,05mm	20,63mm	22,22mm	23,81mm	25,40mm	26,98mm	28,57mm	31,75mm	34,92mm	38,10mm	41,27mm	44,45mm	46,83mm	50,80mm

VEÍCULO		DESCRIÇÃO	ANOS	OBSERVAÇÃO	REF.	IMAGEM
<b>AGRALE</b>						
VOLARE W9		CILINDRO AUXILIAR DE EMBREAGEM 25,40mm	2008/...		C-2653	
VOLARE W9		REPARO DO CIL. MESTRE DE EMBREAGEM 22,22mm	2006/2007		C-1631	
VOLARE W9		REPARO DO CIL. AUXILIAR DE EMBREAGEM 22,22mm	2006/2007		C-1630	
<b>ALFA ROMEO</b>						
145		CILINDRO MESTRE DUPLA 22,22mm	1996/1999	S/ABS	C-2053	
145		REPARO DO CILINDRO MESTRE DUPLA 22,22mm	1996/1999	P/ CIL. BENDIX	C-1130	
145		VEDANTE DO CILINDRO MESTRE	1996/1999		VE-0204	
145	<-	REPARO DE VEDAÇÃO DA PINÇA 54,00mm	1996/1999	SIST. ATE	C-1419	
145	<-	REPARO DE VEDAÇÃO DA PINÇA 54,00mm	1996/1999	SIST. GIRLING	C-1558	
145	<-	TAPA PÓ DO PINO DE GUIA	1996/1999	SIST. GIRLING	TA-0322	
145	->	REPARO DE VEDAÇÃO DA PINÇA 34,00mm	1996/1999		C-1537	
145	->	TAPA PÓ DO PINO DE GUIA	1996/1999		TA-0322	
147	<-	REPARO DE VEDAÇÃO DA PINÇA 54,00mm	2003/2006		C-1587	
147	->	REPARO DE VEDAÇÃO DA PINÇA 38,00mm	2003/2006		C-1551	
155		CILINDRO MESTRE DUPLA 22,22mm	1995/1998	S/ABS	C-2053	
155		REPARO DO CILINDRO MESTRE DUPLA 22,22mm	1995/1998	P/ CIL. BENDIX	C-1130	
155		VEDANTE DO CILINDRO MESTRE	1995/1998		VE-0204	
155	<-	REPARO DE VEDAÇÃO DA PINÇA 54,00mm	1995/1998		C-1558	
155	<-	TAPA PÓ DO PINO DE GUIA	1995/1998		TA-0322	
155	->	REPARO DE VEDAÇÃO DA PINÇA 34,00mm	1995/1998		C-1537	
155	->	TAPA PÓ DO PINO DE GUIA	1995/1998		TA-0322	
156	<-	REPARO DE VEDAÇÃO DA PINÇA 54,00mm	1999/2003		C-1587	
156	->	REPARO DE VEDAÇÃO DA PINÇA 38,00mm	1999/2003		C-1551	
156 SPORTWAGON	<-	REPARO DE VEDAÇÃO DA PINÇA 54,00mm	2001/2004		C-1587	
156 SPORTWAGON	->	REPARO DE VEDAÇÃO DA PINÇA 38,00mm	2001/2004		C-1551	
159	->	REPARO DE VEDAÇÃO DA PINÇA 38,00mm	2007/2009		C-1551	
164	<-	REPARO DE VEDAÇÃO DA PINÇA 54,00mm	1991/1997		C-1558	
164	<-	TAPA PÓ DO PINO DE GUIA	1991/1997		TA-0322	
164	->	REPARO DE VEDAÇÃO DA PINÇA 38,00mm	1991/1997		C-1549	
164	->	TAPA PÓ DO PINO DE GUIA	1991/1997		TA-0322	
166	->	REPARO DE VEDAÇÃO DA PINÇA 38,00mm	1999/2003		C-1551	
2300		VÁLVULA DE RETENÇÃO DE VÁCUO BRANCA	1981/1986	P/ SERVO VARGA FD180/SM200	C-1750	
2300		REPARO DO CILINDRO MESTRE DUPLA 23,81mm	1983/1986		C-1021	
2300		VEDANTE DO CILINDRO MESTRE	1983/1986		VE-0201	
2300	<-	REPARO DE VEDAÇÃO DA PINÇA 57,00mm	1974/1986		C-1501	
2300	->	REPARO DE VEDAÇÃO DA PINÇA 40,00mm	1974/1986		C-1498	
SPIDER		CILINDRO MESTRE DUPLA 22,22mm	1996/1998	S/ABS	C-2053	
SPIDER		REPARO DO CILINDRO MESTRE DUPLA 22,22mm	1996/1998	P/ CIL. BENDIX	C-1130	
SPIDER		VEDANTE DO CILINDRO MESTRE	1996/1998		VE-0204	
SPIDER	->	REPARO DE VEDAÇÃO DA PINÇA 34,00mm	1996/1998		C-1537	
SPIDER	->	TAPA PÓ DO PINO DE GUIA	1996/1998		TA-0322	

BUSCA POR VEÍCULOS

Tabela de Conversão	Polegadas	9/16"	5/8"	11/16"	7/10"	3/4"	13/16"	7/8"	15/16"	1"	1 1/16"	1 1/8"	1 1/4"	1 3/8"	1 1/2"	1 5/8"	1 3/4"	1 27/32"	2"
	Milímetros	14,28mm	15,87mm	17,46mm	17,78mm	19,05mm	20,63mm	22,22mm	23,81mm	25,40mm	26,98mm	28,57mm	31,75mm	34,92mm	38,10mm	41,27mm	44,45mm	46,83mm	50,80mm











VEÍCULO		DESCRIÇÃO	ANOS	OBSERVAÇÃO	REF.	IMAGEM
<b>ASIA</b>						
ROCSTA	->	CILINDRO DE RODA ESQUERDA 19,05mm	1994/1995		C-3452	
ROCSTA	->	CILINDRO DE RODA DIREITA 19,05mm	1994/1995		C-3453	
ROCSTA	->	REPARO DO CILINDRO DE RODA 19,05mm	1994/1995		C-1573	
ROCSTA	->	COPO DO CILINDRO DE RODA 19,05mm	1994/1995		CO-1312	
ROCSTA	->	TAPA-PÓ DO CILINDRO DE RODA	1994/1995		TA-0373	
TOPIC		CILINDRO MESTRE DE EMBREAGEM 15,87mm	1993/1999		C-2634	
TOPIC		CILINDRO AUXILIAR DE EMBREAGEM 19,05mm	1993/1999		C-2636	
TOPIC		REPARO DO CIL. MESTRE DE EMBREAGEM 15,87mm	1993/1999		C-1642	
TOPIC		REPARO DO CIL. AUXILIAR DE EMBREAGEM 19,05mm	1993/1999		C-1644	
TOPIC		CILINDRO MESTRE DUPL0 22,22mm	1993/1999		C-2089	
TOPIC		REPARO DO CILINDRO MESTRE DUPL0 22,22mm	1993/1999		C-1149	
TOPIC		VEDANTE DO CILINDRO MESTRE	1993/1999		VE-0207	
TOPIC	<-	REPARO DE VEDAÇÃO DA PINÇA 60,50mm	1993/1999		C-1585	
TOPIC	->	CILINDRO DE RODA ESQUERDA 19,05mm	1993/1999		C-3452	
TOPIC	->	CILINDRO DE RODA DIREITA 19,05mm	1993/1999		C-3453	
TOPIC	->	REPARO DO CILINDRO DE RODA 19,05mm	1993/1999		C-1573	
TOPIC	->	COPO DO CILINDRO DE RODA 19,05mm	1993/1999		CO-1312	
TOPIC	->	TAPA-PÓ DO CILINDRO DE RODA	1993/1999		TA-0373	
TOWNER	<-	REPARO DE VEDAÇÃO DA PINÇA 51,00mm	1993/1999		C-1586	
TOWNER	->	CILINDRO DE RODA ESQUERDA 17,46mm	1993/1999		C-3450	
TOWNER	->	CILINDRO DE RODA DIREITA 17,46mm	1993/1999		C-3451	

Tabela de Conversão	Polegadas	9/16"	5/8"	11/16"	7/10"	3/4"	13/16"	7/8"	15/16"	1"	1 1/16"	1 1/8"	1 1/4"	1 3/8"	1 1/2"	1 5/8"	1 3/4"	1 27/32"	2"
	Milímetros		14,28mm	15,87mm	17,46mm	17,78mm	19,05mm	20,63mm	22,22mm	23,81mm	25,40mm	26,98mm	28,57mm	31,75mm	34,92mm	38,10mm	41,27mm	44,45mm	46,83mm

VEÍCULO		DESCRIÇÃO	ANOS	OBSERVAÇÃO	REF.	IMAGEM
<b>ASIA</b>						
TOWNER	->	REPARO DO CILINDRO DE RODA 17,46mm	1993/1999		C-1572	
TOWNER	->	GAXETA DO CILINDRO DE RODA 17,46mm	1993/1999		GA-0309	
TOWNER	->	TAPA-PÓ DO CILINDRO DE RODA	1993/1999		TA-0374	
<b>AUDI</b>						
80	<-	REPARO DE VEDAÇÃO DA PINÇA 54,00mm	1993/1995	MOTOR 2.0	C-1558	
80	<-	TAPA PÓ DO PINO DE GUIA	1993/1995	MOTOR 2.0	TA-0322	
80	->	CILINDRO DE RODA 20,63mm	1993/1994	MOTOR 2.0 8V S/ABS	C-3480	
80	->	REPARO DO CILINDRO DE RODA 20,63mm	1993/1994	MOTOR 2.0 8V S/ABS	C-1593	
80	->	GAXETA DO CILINDRO DE RODA 20,63mm	1993/1994	MOTOR 2.0 8V S/ABS	GA-0217	
80	->	TAPA PÓ DO CILINDRO DE RODA	1993/1994	MOTOR 2.0 8V S/ABS	TA-0343	
80	->	REPARO DE VEDAÇÃO DA PINÇA 38,00mm	1993/1995		C-1549	
80	->	TAPA PÓ DO PINO DE GUIA	1993/1995		TA-0322	
80 AVANT	<-	REPARO DE VEDAÇÃO DA PINÇA 54,00mm	1993/1996	MOTOR 2.0	C-1558	
80 AVANT	<-	TAPA PÓ DO PINO DE GUIA	1993/1996	MOTOR 2.0	TA-0322	
80 AVANT	->	CILINDRO DE RODA 20,63mm	1993/1994	MOTOR 2.0 8V S/ABS	C-3480	
80 AVANT	->	REPARO DO CILINDRO DE RODA 20,63mm	1993/1994	MOTOR 2.0 8V S/ABS	C-1593	
80 AVANT	->	GAXETA DO CILINDRO DE RODA 20,63mm	1993/1994	MOTOR 2.0 8V S/ABS	GA-0217	
80 AVANT	->	TAPA PÓ DO CILINDRO DE RODA	1993/1994	MOTOR 2.0 8V S/ABS	TA-0343	
80 AVANT	->	REPARO DE VEDAÇÃO DA PINÇA 38,00mm	1993/1996		C-1549	
80 AVANT	->	TAPA PÓ DO PINO DE GUIA	1993/1996		TA-0322	
100	<-	REPARO DE VEDAÇÃO DA PINÇA 57,00mm	1993/1995		C-1567	
100	->	REPARO DE VEDAÇÃO DA PINÇA 38,00mm	1993/1995		C-1549	
100	->	TAPA PÓ DO PINO DE GUIA	1993/1995		TA-0322	
100 AVANT	<-	REPARO DE VEDAÇÃO DA PINÇA 57,00mm	1994/1995		C-1567	
100 AVANT	->	REPARO DE VEDAÇÃO DA PINÇA 38,00mm	1994/1995		C-1549	
100 AVANT	->	TAPA PÓ DO PINO DE GUIA	1994/1995		TA-0322	
A3		CILINDRO MESTRE DE EMBREAGEM 15,87mm	1997/2006		C-2650	
A3		CILINDRO AUXILIAR DE EMBREAGEM 19,05mm	1997/2002		C-2656	
A3		CILINDRO AUXILIAR DE EMBREAGEM 19,05mm	2003/2006	MOTOR 1.6 101 CV	C-2651	
A3		CILINDRO AUXILIAR DE EMBREAGEM 19,05mm	2003/2006	MOTOR 1.8	C-2656	

BUSCA POR VEÍCULOS

Tabela de Conversão	Polegadas	9/16"	5/8"	11/16"	7/10"	3/4"	13/16"	7/8"	15/16"	1"	1 1/16"	1 1/8"	1 1/4"	1 3/8"	1 1/2"	1 5/8"	1 3/4"	1 27/32"	2"
	Milímetros	14,28mm	15,87mm	17,46mm	17,78mm	19,05mm	20,63mm	22,22mm	23,81mm	25,40mm	26,98mm	28,57mm	31,75mm	34,92mm	38,10mm	41,27mm	44,45mm	46,83mm	50,80mm







VEÍCULO		DESCRIÇÃO	ANOS	OBSERVAÇÃO	REF.	IMAGEM
<b>AUDI</b>						
A3		CILINDRO AUXILIAR DE EMBREAGEM 19,05mm	2007/2010	MOTOR 1.6 102 CV	C-2651	
A3		CILINDRO MESTRE DUPL0 23,81mm	1997/2006		C-2095	
A3		REPARO DO CILINDRO MESTRE DUPL0 23,81mm	1997/2006		C-1172	
A3		VEDANTE DO CILINDRO MESTRE	1997/2006		VE-0204	
A3	<-	REPARO DE VEDAÇÃO DA PINÇA 54,00mm	1997/...		C-1587	
A3	->	REPARO DE VEDAÇÃO DA PINÇA 38,00mm	1997/...		C-1551	
A3 SPORTBACK		CILINDRO AUXILIAR DE EMBREAGEM 19,05mm	2007/2010	MOTOR 1.6 102 CV	C-2651	
A3 SPORTBACK	<-	REPARO DE VEDAÇÃO DA PINÇA 54,00mm	2007/...		C-1587	
A3 SPORTBACK	->	REPARO DE VEDAÇÃO DA PINÇA 38,00mm	2007/...		C-1551	
A4	<-	REPARO DE VEDAÇÃO DA PINÇA 54,00mm	1995/2000	SIST. GIRLING	C-1558	
A4	<-	REPARO DE VEDAÇÃO DA PINÇA 57,00mm	1995/2008	SIST. ATE	C-1567	
A4	<-	TAPA PÓ DO PINO DE GUIA	1995/2000	SIST. GIRLING	TA-0322	
A4	->	REPARO DE VEDAÇÃO DA PINÇA 38,00mm	1995/2008		C-1551	
A4 AVANT	<-	REPARO DE VEDAÇÃO DA PINÇA 54,00mm	1995/2001	SIST. GIRLING	C-1558	
A4 AVANT	<-	REPARO DE VEDAÇÃO DA PINÇA 57,00mm	1995/2008	SIST. ATE	C-1567	
A4 AVANT	<-	TAPA PÓ DO PINO DE GUIA	1995/2001	SIST. GIRLING	TA-0322	
A4 AVANT	->	REPARO DE VEDAÇÃO DA PINÇA 38,00mm	1995/2008		C-1551	
A6	<-	REPARO DE VEDAÇÃO DA PINÇA 57,00mm	1994/2011		C-1567	
A6	->	REPARO DE VEDAÇÃO DA PINÇA 38,00mm	1994/1997		C-1549	
A6	->	REPARO DE VEDAÇÃO DA PINÇA 38,00mm	1998/2004		C-1551	
A6	->	TAPA PÓ DO PINO DE GUIA	1994/1997		TA-0322	
A6 AVANT	<-	REPARO DE VEDAÇÃO DA PINÇA 57,00mm	1994/2011		C-1567	
A6 AVANT	->	REPARO DE VEDAÇÃO DA PINÇA 38,00mm	1994/1997		C-1549	
A6 AVANT	->	REPARO DE VEDAÇÃO DA PINÇA 38,00mm	1998/2004		C-1551	
A6 AVANT	->	TAPA PÓ DO PINO DE GUIA	1994/1997		TA-0322	
TT		CILINDRO MESTRE DE EMBREAGEM 15,87mm	1999/2006		C-2650	
TT		CILINDRO AUXILIAR DE EMBREAGEM 19,05mm	1999/2006		C-2656	
TT		CILINDRO MESTRE DUPL0 23,81mm	1999/2006		C-2095	
TT		REPARO DO CILINDRO MESTRE DUPL0 23,81mm	1999/2006		C-1172	
TT		VEDANTE DO CILINDRO MESTRE	1999/2006		VE-0204	
TT	<-	REPARO DE VEDAÇÃO DA PINÇA 54,00mm	1999/2006		C-1587	
TT	->	REPARO DE VEDAÇÃO DA PINÇA 38,00mm	1999/...		C-1551	
<b>BMW</b>						
SÉRIE 3	<-	REPARO DE VEDAÇÃO DA PINÇA 54,00mm	1991/2005		C-1587	

Tabela de Conversão	Polegadas	9/16"	5/8"	11/16"	7/10"	3/4"	13/16"	7/8"	15/16"	1"	1 1/16"	1 1/8"	1 1/4"	1 3/8"	1 1/2"	1 5/8"	1 3/4"	1 27/32"	2"
	Milímetros	14,28mm	15,87mm	17,46mm	17,78mm	19,05mm	20,63mm	22,22mm	23,81mm	25,40mm	26,98mm	28,57mm	31,75mm	34,92mm	38,10mm	41,27mm	44,45mm	46,83mm	50,80mm

VEÍCULO		DESCRIÇÃO	ANOS	OBSERVAÇÃO	REF.	IMAGEM
<b>BMW</b>						
SÉRIE 3	<-	REPARO DE VEDAÇÃO DA PINÇA 60,00mm	1992/1999	MOD. M3	C-1545	
SÉRIE 5	<-	REPARO DE VEDAÇÃO DA PINÇA 60,00mm	1991/1995		C-1545	
SÉRIE 5	<-	REPARO DE VEDAÇÃO DA PINÇA 60,00mm	1996/2003	MOD. 530/535/540/M5	C-1545	
SÉRIE 5 TOURING	<-	REPARO DE VEDAÇÃO DA PINÇA 60,00mm	1991/1997		C-1545	
SÉRIE 5 TOURING	<-	REPARO DE VEDAÇÃO DA PINÇA 60,00mm	1997/2004	MOD. 530/540	C-1545	
SÉRIE 7	<-	REPARO DE VEDAÇÃO DA PINÇA 60,00mm	1991/1994		C-1545	
SÉRIE 7	<-	REPARO DE VEDAÇÃO DA PINÇA 60,00mm	1994/2001	MOD. 740	C-1545	
SÉRIE 8	<-	REPARO DE VEDAÇÃO DA PINÇA 60,00mm	1990/1999		C-1545	
X5	<-	REPARO DE VEDAÇÃO DA PINÇA 60,00mm	2000/...	E353	C-1545	
Z3	<-	REPARO DE VEDAÇÃO DA PINÇA 54,00mm	1995/2003		C-1587	
Z3	<-	REPARO DE VEDAÇÃO DA PINÇA 60,00mm	1997/2003	MOD. M 3.2	C-1545	
<b>CHRYSLER</b>						
DODGE 1800		VÁLVULA DE RETENÇÃO DE VÁCUO	1976/1976		C-1755	
DODGE 1800	->	REPARO DO CILINDRO DE RODA 22,22mm	1976/1976		C-1442	
DODGE 1800	->	COPO DO CILINDRO DE RODA 22,22mm	1976/1976		CO-1315	
DODGE 1800	->	TAPA-PÓ DO CILINDRO DE RODA	1973/1976		TA-0310	
DODGE CHARGER		VÁLVULA DE RETENÇÃO DE VÁCUO BRANCA	1970/1981		C-1750	
DODGE CHARGER		VEDANTE DO CILINDRO MESTRE	1970/1981		VE-0200	
DODGE DART		VÁLVULA DE RETENÇÃO DE VÁCUO BRANCA	1970/1981		C-1750	
DODGE DART		VEDANTE DO CILINDRO MESTRE	1970/1981		VE-0200	
DODGE LE BARON		VÁLVULA DE RETENÇÃO DE VÁCUO BRANCA	1980/1981		C-1750	
DODGE LE BARON		VEDANTE DO CILINDRO MESTRE	1980/1981		VE-0200	
DODGE MAGNUM		VÁLVULA DE RETENÇÃO DE VÁCUO BRANCA	1980/1981		C-1750	
DODGE MAGNUM		VEDANTE DO CILINDRO MESTRE	1980/1981		VE-0200	
POLARA		VÁLVULA DE RETENÇÃO DE VÁCUO BRANCA	1977/1981	P/ SERVO FD150	C-1750	
POLARA		VÁLVULA DE RETENÇÃO DE VÁCUO	1977/1981		C-1753	
POLARA		VEDANTE DO CILINDRO MESTRE	1977/1981		VE-0200	
POLARA	->	REPARO DO CILINDRO DE RODA 22,22mm	1977/1981		C-1442	
POLARA	->	COPO DO CILINDRO DE RODA 22,22mm	1977/1981		CO-1315	
POLARA	->	TAPA-PÓ DO CILINDRO DE RODA	1977/1981		TA-0310	
<b>CHRYSLER - CAMINHÕES</b>						
D-400		REPARO DO CILINDRO MESTRE SIMPLES 31,75mm	1970/1978		C-1059	
D-400	<-	REPARO DO CILINDRO DE RODA 28,57mm	1970/1978		C-1408	
D-400	<-	COPO DO CILINDRO DE RODA 28,57mm	1970/1978		CO-1309	
D-400	<-	TAPA-PÓ DO CILINDRO DE RODA	1970/1978		TA-0314	
D-400	->	REPARO DO CILINDRO DE RODA 31,75mm	1970/1978		C-1412	
D-400	->	COPO DO CILINDRO DE RODA 31,75mm	1970/1978		CO-1300	
D-400	->	TAPA-PÓ DO CILINDRO DE RODA	1970/1978		TA-0350	
D-700		REPARO DO HYDROVAC 9 1/2"	1970/1981		C-1213	
D-700		REPARO DO CILINDRO MESTRE SIMPLES 38,10mm	1970/1981		C-1011	
D-700	<-	COPO DO CILINDRO DE RODA 25,40mm	1970/1981		CO-1307	
D-700	<-	TAPA-PÓ DO CILINDRO DE RODA	1970/1981		TA-0314	
D-700	->	REPARO DO CILINDRO DE RODA 41,27mm	1970/1981	P/ CILINDRO VARGA	C-1487	
D-700	->	REPARO DO CILINDRO DE RODA 41,27mm	1974/1981	P/ CILINDRO BENDIX	C-1485	
D-700	->	COPO DO CILINDRO DE RODA 41,27mm	1970/1981	P/ CILINDRO VARGA	CO-1316	
D-700	->	GAXETA DO CILINDRO DE RODA 41,27mm	1974/1981	P/ CILINDRO BENDIX	GA-0300	
D-700	->	TAPA-PÓ DO CILINDRO DE RODA	1970/1981		TA-0323	
P-400		REPARO DO HYDROVAC 9 1/2"	1979/1981		C-1213	
P-400		REPARO DO CILINDRO MESTRE SIMPLES 31,75mm	1978/1981		C-1059	
P-400	->	REPARO DO CILINDRO DE RODA 31,75mm	1978/1981		C-1412	
P-400	->	COPO DO CILINDRO DE RODA 31,75mm	1978/1981		CO-1300	
P-400	->	TAPA-PÓ DO CILINDRO DE RODA	1978/1981		TA-0350	
<b>CITROËN</b>						
AIRCROSS		CILINDRO MESTRE DE EMBREAGEM 15,87mm	2010/...		C-2681	

BUSCA POR VEÍCULOS

Tabela de Conversão	Polegadas	9/16"	5/8"	11/16"	7/10"	3/4"	13/16"	7/8"	15/16"	1"	1 1/16"	1 1/8"	1 1/4"	1 3/8"	1 1/2"	1 5/8"	1 3/4"	1 27/32"	2"
	Milímetros	14,28mm	15,87mm	17,46mm	17,78mm	19,05mm	20,63mm	22,22mm	23,81mm	25,40mm	26,98mm	28,57mm	31,75mm	34,92mm	38,10mm	41,27mm	44,45mm	46,83mm	50,80mm

VEÍCULO		DESCRIÇÃO	ANOS	OBSERVAÇÃO	REF.	IMAGEM
<b>CITROËN</b>						
AIRCROSS	->	CILINDRO DE RODA 22,22mm	2011/...	1.6 16V	C-3547	
AX		CILINDRO MESTRE DUPLO 20,63mm	1993/1996	MOD. GTI	C-2065	
AX		REPARO DO CILINDRO MESTRE DUPLO 20,63mm	1993/1996	MOD. GTI C/ CIL. CONTROL	C-1165	
AX		VEDANTE DO CILINDRO MESTRE	1993/1996		VE-0204	
BERLINGO		CILINDRO MESTRE DUPLO 23,81mm	2001/2007	S/ABS	C-2171	
BERLINGO	<-	REPARO DE VEDAÇÃO DA PINÇA 54,00mm	2000/2002	FURGÃO	C-1530	
BERLINGO	->	CILINDRO DE RODA 22,22mm	1998/2007		C-3505	
BERLINGO	->	REPARO DO CILINDRO DE RODA 22,22mm	1998/2007		C-1582	
BERLINGO	->	GAXETA DO CILINDRO DE RODA 22,22mm	1998/2007		GA-0207	
BERLINGO	->	TAPA-PÓ DO CILINDRO DE RODA	1998/2007		TA-0312	
C3		CILINDRO MESTRE DE EMBREAGEM 15,87mm	2004/...	1.4 8V / 1.6 16V	C-2681	
C3		CILINDRO MESTRE DE EMBREAGEM 15,87mm	2011/...	C3 PICASSO	C-2681	
C3		CILINDRO MESTRE DE EMBREAGEM 15,87mm	2013/...	1.5/1.6 16V	C-2681	
C3		CILINDRO AUXILIAR DE EMBREAGEM 19,05mm	2004/...	1.4 8V / 1.6 16V	C-2682	
C3		CILINDRO MESTRE DUPLO 20,63mm	2002/2012	S/ABS	C-2172	
C3	<-	REPARO DE VEDAÇÃO DA PINÇA 54,00mm	2003/2005		C-1530	
C3	->	CILINDRO DE RODA ESQ. 19,05mm C/ VÁLV. REG.	2002/2009	S/ABS	C-3524	

Tabela de Conversão	Polegadas	9/16"	5/8"	11/16"	7/10"	3/4"	13/16"	7/8"	15/16"	1"	1 1/16"	1 1/8"	1 1/4"	1 3/8"	1 1/2"	1 5/8"	1 3/4"	1 27/32"	2"
	Milímetros	14,28mm	15,87mm	17,46mm	17,78mm	19,05mm	20,63mm	22,22mm	23,81mm	25,40mm	26,98mm	28,57mm	31,75mm	34,92mm	38,10mm	41,27mm	44,45mm	46,83mm	50,80mm



VEÍCULO		DESCRIÇÃO	ANOS	OBSERVAÇÃO	REF.	IMAGEM
<b>CITROËN</b>						
C3	->	CILINDRO DE RODA DIR. 19,05mm C/ VÁLV. REG.	2002/2009	S/ABS	C-3525	
C3	->	CILINDRO DE RODA 20,63mm	2006/2012	C/ABS	C-3535	
C3	->	CILINDRO DE RODA 19,05mm	2010/2012	S/ABS	C-3538	
C3	->	CILINDRO DE RODA 22,22mm	2011/...	PICASSO 1.6 16V	C-3547	
C3	->	CILINDRO DE RODA 20,63mm	2013/...	(NOVO)	C-3496	
C3	->	REPARO DE VEDAÇÃO DA PINÇA 38,00mm	2002/2012		C-1551	
C3		JOGO ANÉIS VEDAÇÃO COLETOR DE ADMISSÃO	2002/...	MOTOR 1.6 16V	C-9503	
C4		CILINDRO MESTRE DE EMBREAGEM 15,87mm	2003/...	2.0 16V	C-2685	
C4		CILINDRO MESTRE DE EMBREAGEM 15,87mm	2003/...		C-2686	
C4		CILINDRO AUXILIAR DE EMBREAGEM 19,05mm	2003/...	2.0 16V	C-2687	
C4		CILINDRO MESTRE DUPLO 23,81mm	2004/2007	2.0 VTR 16V	C-2193	
C4		CILINDRO MESTRE DUPLO 23,81mm	2006/2009	2.0 16V	C-2193	
C4	->	REPARO DE VEDAÇÃO DA PINÇA 38,00mm	2004/...	SIST. TRW	C-1551	

Tabela de Conversão	Polegadas	9/16"	5/8"	11/16"	7/10"	3/4"	13/16"	7/8"	15/16"	1"	1 1/16"	1 1/8"	1 1/4"	1 3/8"	1 1/2"	1 5/8"	1 3/4"	1 27/32"	2"
	Milímetros	14,28mm	15,87mm	17,46mm	17,78mm	19,05mm	20,63mm	22,22mm	23,81mm	25,40mm	26,98mm	28,57mm	31,75mm	34,92mm	38,10mm	41,27mm	44,45mm	46,83mm	50,80mm



VEÍCULO		DESCRIÇÃO	ANOS	OBSERVAÇÃO	REF.	IMAGEM
<b>CITROËN</b>						
C4		JOGO ANÉIS VEDAÇÃO COLETOR DE ADMISSÃO	2009/...	MOTOR 1.6 16V	C-9503	
C5	->	REPARO DE VEDAÇÃO DA PINÇA 38,00mm	2008/...	SIST. TRW	C-1551	
C6	->	REPARO DE VEDAÇÃO DA PINÇA 38,00mm	2006/2008		C-1551	
C8	->	REPARO DE VEDAÇÃO DA PINÇA 38,00mm	2003/2005		C-1551	
JUMPER		CILINDRO MESTRE DUPL0 23,81mm	1996/2002	S/ABS	C-2080	
JUMPER		CILINDRO MESTRE DUPL0 25,40mm	2003/...	S/ABS	C-2163	
JUMPER		REPARO DO CILINDRO MESTRE DUPL0 23,81mm	1996/2002		C-1167	
JUMPER		VEDANTE DO CILINDRO MESTRE	1996/2002		VE-0201	
JUMPER	->	CILINDRO DE RODA 26,98mm	1996/2002		C-3486	
JUMPER	->	REPARO DO CILINDRO DE RODA 26,98mm	1996/2002		C-1597	
JUMPER	->	GAXETA DO CILINDRO DE RODA 26,98mm	1996/2002		GA-0321	
XSARA		CILINDRO MESTRE DUPL0 22,22mm	1998/2000	S/ABS	C-2138	
XSARA		CILINDRO MESTRE DUPL0 23,81mm	2001/2003	S/ABS	C-2171	
XSARA	<-	REPARO DE VEDAÇÃO DA PINÇA 54,00mm	1997/2000	1.8 16V	C-1530	
XSARA	<-	REPARO DE VEDAÇÃO DA PINÇA 48,00mm	1998/2003	SIST. ATE	C-1443	
XSARA	<-	REPARO DE VEDAÇÃO DA PINÇA 54,00mm	2001/2005	1.6 16V	C-1530	
XSARA	->	CILINDRO DE RODA 20,63mm	1998/2003	SIST. LUCAS C/ABS	C-3478	
XSARA	->	CILINDRO DE RODA ESQ. 20,63mm C/ VÁLV. REG.	1998/2003	SIST. BENDIX S/ABS	C-3511	
XSARA	->	CILINDRO DE RODA DIR. 20,63mm C/ VÁLV. REG.	1998/2003	SIST. BENDIX S/ABS	C-3512	

Tabela de Conversão	Polegadas	9/16"	5/8"	11/16"	7/10"	3/4"	13/16"	7/8"	15/16"	1"	1 1/16"	1 1/8"	1 1/4"	1 3/8"	1 1/2"	1 5/8"	1 3/4"	1 27/32"	2"
	Milímetros	14,28mm	15,87mm	17,46mm	17,78mm	19,05mm	20,63mm	22,22mm	23,81mm	25,40mm	26,98mm	28,57mm	31,75mm	34,92mm	38,10mm	41,27mm	44,45mm	46,83mm	50,80mm

VEÍCULO		DESCRIÇÃO	ANOS	OBSERVAÇÃO	REF.	IMAGEM
<b>CITROËN</b>						
XSARA	->	CILINDRO DE RODA ESQ. 20,63mm C/ VÁLV. REG.	1998/2003	SIST. LUCAS S/ABS	C-3522	
XSARA	->	CILINDRO DE RODA DIR. 20,63mm C/ VÁLV. REG.	1998/2003	SIST. LUCAS S/ABS	C-3523	
XSARA	->	REPARO DO CILINDRO DE RODA 20,63mm	1998/2003	SIST. LUCAS C/ABS	C-1578	
XSARA	->	GAXETA DO CILINDRO DE RODA 20,63mm	1998/2003	SIST. LUCAS C/ABS	GA-0206	
XSARA	->	TAPA-PÓ DO CILINDRO DE RODA	1998/2003	SIST. LUCAS C/ABS	TA-0312	
XSARA BREAK		CILINDRO MESTRE DUPL0 23,81mm	1997/2001	S/ABS	C-2171	
XSARA BREAK	<-	REPARO DE VEDAÇÃO DA PINÇA 54,00mm	1998/2000	1.8 16V	C-1530	
XSARA BREAK	<-	REPARO DE VEDAÇÃO DA PINÇA 54,00mm	1999/2000	2.0 16V	C-1530	
XSARA BREAK	<-	REPARO DE VEDAÇÃO DA PINÇA 54,00mm	2001/2005	1.6 16V	C-1530	
XSARA PICASSO		CILINDRO AUXILIAR DE EMBREAGEM 19,05mm	2003/...	1.6/2.0 16V	C-2687	
XSARA PICASSO		CILINDRO MESTRE DUPL0 23,81mm	2001/2012	S/ABS	C-2171	
XSARA PICASSO	<-	REPARO DE VEDAÇÃO DA PINÇA 54,00mm	2003/...	2.0 16V	C-1530	
XSARA PICASSO	<-	REPARO DE VEDAÇÃO DA PINÇA 54,00mm	2006	1.6 16V	C-1530	
XSARA PICASSO	<-	REPARO DE VEDAÇÃO DA PINÇA 54,00mm	2010/...	1.6 FLEX	C-1530	
XSARA PICASSO	->	CILINDRO DE RODA 22,22mm	2001/2012		C-3505	
XSARA PICASSO	->	REPARO DO CILINDRO DE RODA 22,22mm	2001/2012		C-1582	
XSARA PICASSO	->	GAXETA DO CILINDRO DE RODA 22,22mm	2001/2012		GA-0207	
XSARA PICASSO	->	TAPA-PÓ DO CILINDRO DE RODA	2001/2012		TA-0312	
ZX		CILINDRO MESTRE DUPL0 20,63mm	1992/1997	1.6/1.8 SIST. TEVES S/ABS	C-2065	
ZX		REPARO DO CILINDRO MESTRE DUPL0 20,63mm	1992/1997	C/ CIL. CONTROL	C-1165	
ZX		VEDANTE DO CILINDRO MESTRE	1992/1998		VE-0204	
ZX	<-	REPARO DE VEDAÇÃO DA PINÇA 54,00mm	1992/1997	MOTOR 2,0 16V	C-1558	
ZX	<-	TAPA PÓ DO PINO DE GUIA	1992/1997	MOTOR 2.0 16V	TA-0322	
ZX	->	CILINDRO DE RODA ESQ. 20,63mm C/ VÁLV. REG.	1992/1998	SIST. BENDIX S/ABS	C-3511	

BUSCA POR VEÍCULOS

Tabela de Conversão	Polegadas	9/16"	5/8"	11/16"	7/10"	3/4"	13/16"	7/8"	15/16"	1"	1 1/16"	1 1/8"	1 1/4"	1 3/8"	1 1/2"	1 5/8"	1 3/4"	1 27/32"	2"
	Milímetros	14,28mm	15,87mm	17,46mm	17,78mm	19,05mm	20,63mm	22,22mm	23,81mm	25,40mm	26,98mm	28,57mm	31,75mm	34,92mm	38,10mm	41,27mm	44,45mm	46,83mm	50,80mm

VEÍCULO		DESCRIÇÃO	ANOS	OBSERVAÇÃO	REF.	IMAGEM
<b>CITROËN</b>						
ZX	->	CILINDRO DE RODA DIR. 20,63mm C/ VÁLV. REG.	1992/1998	SIST. BENDIX S/ABS	C-3512	
ZX	->	CILINDRO DE RODA ESQ. 20,63mm C/ VÁLV. REG.	1992/1998	SIST. LUCAS S/ABS	C-3522	
ZX	->	CILINDRO DE RODA DIR. 20,63mm C/ VÁLV. REG.	1992/1998	SIST. LUCAS S/ABS	C-3523	
ZX	->	CILINDRO DE RODA 20,63mm	1995/1998	C/ABS	C-3478	
ZX	->	REPARO DO CILINDRO DE RODA 20,63mm	1995/1998	C/ABS	C-1578	
ZX	->	GAXETA DO CILINDRO DE RODA 20,63mm	1995/1998	C/ABS	GA-0206	
ZX	->	TAPA-PÓ DO CILINDRO DE RODA	1995/1998	C/ABS	TA-0312	
<b>CROSS LANDER</b>						
CL-244		CIL. ATUADOR CONCÊNTRICO DE EMBREAGEM	2003/2006		C-2702	
CL-330		CIL. ATUADOR CONCÊNTRICO DE EMBREAGEM	2006/2006		C-2702	
<b>DAEWOO</b>						
ESPERO		REPARO DO CILINDRO MESTRE DUPLO 22,22mm	1993/1998	C/ABS E S/ABS	C-1141	
ESPERO		VEDANTE DO CILINDRO MESTRE	1993/1998		VE-0206	
ESPERO	->	CILINDRO DE RODA 19,05mm	1993/1998		C-3410	
ESPERO	->	REPARO DO CILINDRO DE RODA 19,05mm	1993/1998		C-1543	
ESPERO	->	GAXETA DO CILINDRO DE RODA 19,05mm	1993/1998		GA-0307	
ESPERO	->	TAPA-PÓ DO CILINDRO DE RODA	1993/1998		TA-0369	
LANOS	<-	REPARO DE VEDAÇÃO DA PINÇA 48,00mm	1997/2000	SIST. ATE C/ARO 13"	C-1443	
LANOS	->	CILINDRO DE RODA 19,05mm	1997/2000		C-3410	
LANOS	->	REPARO DO CILINDRO DE RODA 19,05mm	1997/2000		C-1543	
LANOS	->	GAXETA DO CILINDRO DE RODA 19,05mm	1997/2000		GA-0307	
LANOS	->	TAPA-PÓ DO CILINDRO DE RODA	1997/2000		TA-0369	
<b>DODGE</b>						
DAKOTA		CILINDRO AUXILIAR DE EMBREAGEM 20,63mm	1998/2001		C-2660	

Tabela de Conversão	Polegadas	9/16"	5/8"	11/16"	7/10"	3/4"	13/16"	7/8"	15/16"	1"	1 1/16"	1 1/8"	1 1/4"	1 3/8"	1 1/2"	1 5/8"	1 3/4"	1 27/32"	2"
	Milímetros	14,28mm	15,87mm	17,46mm	17,78mm	19,05mm	20,63mm	22,22mm	23,81mm	25,40mm	26,98mm	28,57mm	31,75mm	34,92mm	38,10mm	41,27mm	44,45mm	46,83mm	50,80mm

VEÍCULO		DESCRIÇÃO	ANOS	OBSERVAÇÃO	REF.	IMAGEM
<b>FIAT</b>						
147/SPAZIO		SERVO FREIO 200mm	1983/1987	SIST. VARGA	C-5630	
147/SPAZIO		VÁLVULA DE RETENÇÃO DE VÁCUO	1976/1987	SIST. BENDIX	C-1755	
147/SPAZIO		VÁLVULA DE RETENÇÃO DE VÁCUO BRANCA	1983/1987	P/ SERVO VARGA SM180	C-1750	
147/SPAZIO		VÁLVULA DE RETENÇÃO DE VÁCUO	1983/1987	SIST. VARGA	C-1753	
147/SPAZIO		CILINDRO MESTRE DUPL0 19,05mm	1976/1987	SIST. ATE C/ E S/SERVO	C-2006	
147/SPAZIO		CILINDRO MESTRE DUPL0 20,63mm	1983/1987	SIST. VARGA	C-2087	
147/SPAZIO		REPARO DO CILINDRO MESTRE DUPL0 19,05mm	1976/1987	SIST. ATE C/ E S/SERVO	C-1098	
147/SPAZIO		REPARO DO CILINDRO MESTRE DUPL0 20,63mm	1983/1987	SIST. VARGA	C-1028	
147/SPAZIO		RESERVATÓRIO C/ TAMP A E AVISO DE NÍVEL	1983/1987	SIST. VARGA	C-0102	
147/SPAZIO		VEDANTE DO CILINDRO MESTRE	1976/1987	SIST. ATE	VE-0204	
147/SPAZIO		VEDANTE DO CILINDRO MESTRE	1983/1987	SIST. VARGA	VE-0201	
147/SPAZIO	<-	REPARO DE VEDAÇÃO DA PINÇA 48,00mm	1976/1987	SIST. BENDIX	C-1421	
147/SPAZIO	<-	REPARO DE VEDAÇÃO DA PINÇA 48,00mm	1981/1987	SIST. ATE (2 RODAS)	C-1434	
147/SPAZIO	->	CILINDRO DE RODA 19,05mm	1976/1987		C-3355	
147/SPAZIO	->	REPARO DO CILINDRO DE RODA 19,05mm	1976/1987	P/ CILINDRO BENDIX	C-1424	
147/SPAZIO	->	REPARO DO CILINDRO DE RODA 19,05mm	1976/1987		C-1427	
147/SPAZIO	->	COPO DO CILINDRO DE RODA 19,05mm	1976/1987	P/ CILINDRO BENDIX	CO-1312	
147/SPAZIO	->	GAXETA DO CILINDRO DE RODA 19,05mm	1976/1987		GA-0307	
147/SPAZIO	->	TAPA-PÓ DO CILINDRO DE RODA	1976/1987		TA-0303	
147/SPAZIO	->	TAPA-PÓ DO CILINDRO DE RODA	1976/1987	P/ CILINDRO BENDIX	TA-0310	
BRAVA		SERVO FREIO 200mm	2000/2002	MOTOR 1.6 16V	C-5626	
BRAVA		CILINDRO MESTRE DUPL0 22,22mm	2000/2002	MOTOR 1.6 16V S/ABS	C-2053	
BRAVA		CILINDRO MESTRE DUPL0 23,81mm	2000/2003	MOTOR 1.8 16V	C-2142	
BRAVA		REPARO DO CILINDRO MESTRE DUPL0 22,22mm	2000/2002	MOTOR 1.6 16V C/ CIL. BENDIX	C-1130	
BRAVA		VEDANTE DO CILINDRO MESTRE	2000/2003		VE-0204	
BRAVA	->	CILINDRO DE RODA 20,63mm	2000/2003		C-3411	

BUSCA POR VEÍCULOS

Tabela de Conversão	Polegadas	9/16"	5/8"	11/16"	7/10"	3/4"	13/16"	7/8"	15/16"	1"	1 1/16"	1 1/8"	1 1/4"	1 3/8"	1 1/2"	1 5/8"	1 3/4"	1 27/32"	2"
	Milímetros	14,28mm	15,87mm	17,46mm	17,78mm	19,05mm	20,63mm	22,22mm	23,81mm	25,40mm	26,98mm	28,57mm	31,75mm	34,92mm	38,10mm	41,27mm	44,45mm	46,83mm	50,80mm

VEÍCULO		DESCRIÇÃO	ANOS	OBSERVAÇÃO	REF.	IMAGEM
<b>FIAT</b>						
BRAVA	->	REPARO DO CILINDRO DE RODA 20,63mm	2000/2003		C-1534	
BRAVA	->	COPO DO CILINDRO DE RODA 20,63mm	2000/2003		CO-1317	
BRAVA	->	TAPA-PÓ DO CILINDRO DE RODA	2000/2003		TA-0321	
COUPÉ		SERVO FREIO 200mm	1995/1997		C-5626	
COUPÉ		VÁLVULA DE RETENÇÃO DE VÁCUO	1995/1997		C-1753	
COUPÉ		CILINDRO MESTRE DUPLO 22,22mm	1995/1997	S/ABS	C-2053	
COUPÉ		REPARO DO CILINDRO MESTRE DUPLO 22,22mm	1995/1997	P/ CIL. BENDIX	C-1130	
COUPÉ		VEDANTE DO CILINDRO MESTRE	1995/1997		VE-0204	
COUPÉ	<-	REPARO DE VEDAÇÃO DA PINÇA 54,00mm	1995/1997		C-1558	
COUPÉ	<-	TAPA PÓ DO PINO DE GUIA	1995/1997		TA-0322	
COUPÉ	->	REPARO DE VEDAÇÃO DA PINÇA 34,00mm	1995/1997		C-1537	
COUPÉ	->	TAPA PÓ DO PINO DE GUIA	1995/1997		TA-0322	
DOBLÔ		CIL. ATUADOR CONCÊNTRICO DE EMBREAGEM	2005/...	MOTOR 1.8 8V / EtorQ 1.8 16V	C-2712	
DOBLÔ		CILINDRO MESTRE DUPLO 22,22mm	2002/...	S/ABS	C-2139	
DOBLÔ		REPARO DO CILINDRO MESTRE DUPLO 22,22mm	2002/...	S/ABS	C-1180	
DOBLÔ		VEDANTE DO CILINDRO MESTRE	2002/...		VE-0204	
DOBLÔ	<-	REPARO DE VEDAÇÃO DA PINÇA 54,00mm	2002/...		C-1419	
DOBLÔ	->	CILINDRO DE RODA 20,63mm	2002/ 2012	EXCETO ADVENTURE	C-3411	
DOBLÔ	->	REPARO DO CILINDRO DE RODA 20,63mm	2002/2012	EXCETO ADVENTURE	C-1534	
DOBLÔ	->	COPO DO CILINDRO DE RODA 20,63mm	2002/...		CO-1317	
DOBLÔ	->	TAPA-PÓ DO CILINDRO DE RODA	2002/...		TA-0321	
DOBLÔ		JOGO ANÉIS VEDAÇÃO COLETOR DE ADMISSÃO	2006/...	MOTOR 1.8 FLEX 8V	C-9501	
DUCATO		CILINDRO MESTRE DUPLO 23,81mm	1998/1998	10/15 LUGARES S/ABS	C-2080	
DUCATO		CILINDRO MESTRE DUPLO 25,40mm	1998/1998	8/10 S/ABS	C-2137	

Tabela de Conversão	Polegadas	9/16"	5/8"	11/16"	7/10"	3/4"	13/16"	7/8"	15/16"	1"	1 1/16"	1 1/8"	1 1/4"	1 3/8"	1 1/2"	1 5/8"	1 3/4"	1 27/32"	2"
	Milímetros		14,28mm	15,87mm	17,46mm	17,78mm	19,05mm	20,63mm	22,22mm	23,81mm	25,40mm	26,98mm	28,57mm	31,75mm	34,92mm	38,10mm	41,27mm	44,45mm	46,83mm

VEÍCULO		DESCRIÇÃO	ANOS	OBSERVAÇÃO	REF.	IMAGEM
<b>FIAT</b>						
DUCATO		CILINDRO MESTRE DUPL0 23,81mm	1999/2000	15/COMB./MINIBUS/MAXI S/TURBO S/ABS	C-2080	
DUCATO		CILINDRO MESTRE DUPL0 25,40mm	1999/2001	15/COMB./MINIBUS/MAXI TURBO S/ABS	C-2137	
DUCATO		CILINDRO MESTRE DUPL0 23,81mm	2002/2002	MINIBUS S/INTERCOOLER S/ABS	C-2080	
DUCATO		CILINDRO MESTRE DUPL0 25,40mm	2002/2002	15/COMB./MINIBUS/MAXI TD INTERC. S/ABS	C-2137	
DUCATO		CILINDRO MESTRE DUPL0 25,40mm	2003/...	S/ABS	C-2163	
DUCATO		REPARO DO CILINDRO MESTRE DUPL0 23,81mm	1998/1998	10/15 LUGARES	C-1167	
DUCATO		REPARO DO CILINDRO MESTRE DUPL0 23,81mm	1999/2000	15/COMBINATO/MINIBUS/MAXI S/TURBO	C-1167	
DUCATO		REPARO DO CILINDRO MESTRE DUPL0 23,81mm	2002/2002	MINIBUS S/INTERCOOLER	C-1167	
DUCATO		VEDANTE DO CILINDRO MESTRE	1998/2002		VE-0201	
DUCATO	->	CILINDRO DE RODA 26,98mm	1998/1998	10/15 LUGARES	C-3486	
DUCATO	->	CILINDRO DE RODA 28,57mm	1998/1998	8-Oct	C-3510	
DUCATO	->	CILINDRO DE RODA 26,98mm	1999/2002	15/COMBINATO/MINIBUS	C-3486	
DUCATO	->	CILINDRO DE RODA 28,57mm	1999/2002	MAXI	C-3510	
DUCATO	->	REPARO DO CILINDRO DE RODA 28,57mm	1998/1998	8-Oct	C-1440	
DUCATO	->	REPARO DO CILINDRO DE RODA 26,98mm	1998/1998	10/15 LUGARES	C-1597	
DUCATO	->	REPARO DO CILINDRO DE RODA 28,57mm	1999/2002	MAXI	C-1440	
DUCATO	->	REPARO DO CILINDRO DE RODA 26,98mm	1999/2002	15/COMBINATO/MINIBUS	C-1597	
DUCATO	->	GAXETA DO CILINDRO DE RODA 26,98mm	1998/1998	10/15 LUGARES	GA-0321	
DUCATO	->	GAXETA DO CILINDRO DE RODA 28,57mm	1998/1998	8-Oct	GA-0322	
DUCATO	->	GAXETA DO CILINDRO DE RODA 26,98mm	1999/2002	15/COMBINATO/MINIBUS	GA-0321	
DUCATO	->	GAXETA DO CILINDRO DE RODA 28,57mm	1999/2002	MAXI	GA-0322	

BUSCA POR VEÍCULOS

Tabela de Conversão	Polegadas	9/16"	5/8"	11/16"	7/10"	3/4"	13/16"	7/8"	15/16"	1"	1 1/16"	1 1/8"	1 1/4"	1 3/8"	1 1/2"	1 5/8"	1 3/4"	1 27/32"	2"
	Milímetros	14,28mm	15,87mm	17,46mm	17,78mm	19,05mm	20,63mm	22,22mm	23,81mm	25,40mm	26,98mm	28,57mm	31,75mm	34,92mm	38,10mm	41,27mm	44,45mm	46,83mm	50,80mm

VEÍCULO		DESCRIÇÃO	ANOS	OBSERVAÇÃO	REF.	IMAGEM
<b>FIAT</b>						
DUNA		SERVO FREIO 200mm	1994/1996		C-5613	
DUNA		VÁLVULA DE RETENÇÃO DE VÁCUO	1994/1996		C-1755	
DUNA		CILINDRO MESTRE DUPL0 20,63mm	1994/1996	SIST. ATE	C-2033	
DUNA		CILINDRO MESTRE DUPL0 20,63mm	1994/1996	SIST. BOSCH	C-2035	
DUNA		REPARO DO CILINDRO MESTRE DUPL0 20,63mm	1994/1996	SIST. ATE	C-1110	
DUNA		REPARO DO CILINDRO MESTRE DUPL0 20,63mm	1994/1996	SIST. ATE - REPOSIÇÃO	C-1132	
DUNA		REPARO DO CILINDRO MESTRE DUPL0 20,63mm	1994/1996	SIST. BOSCH	C-1142	
DUNA		VEDANTE DO CILINDRO MESTRE	1994/1996		VE-0204	
DUNA	<-	REPARO DE VEDAÇÃO DA PINÇA 48,00mm	1994/1996	SIST. ATE	C-1443	
DUNA	<-	REPARO DE VEDAÇÃO DA PINÇA 48,00mm	1994/1996	SIST. VARGA	C-1532	
DUNA	<-	TAPA PÓ DO PINO DE GUIA	1994/1996	SIST. VARGA	TA-0322	
DUNA	->	CILINDRO DE RODA AUTOAJUSTÁVEL 19,05mm	1994/1996		C-3509	
DUNA	->	REPARO DO CILINDRO DE RODA AUTOAJ. 19,05mm	1994/1996		C-1428	
DUNA	->	GAXETA DO CILINDRO DE RODA 19,05mm	1994/1996		GA-0307	
DUNA	->	TAPA-PÓ DO CILINDRO DE RODA	1994/1996		TA-0303	
ELBA		SERVO FREIO 200mm	1992/1996	SIST. ATE E BOSCH	C-5613	
ELBA		VÁLVULA DE RETENÇÃO DE VÁCUO	1986/1996		C-1755	
ELBA		CILINDRO MESTRE DUPL0 19,05mm	1986/1991		C-2030	
ELBA		CILINDRO MESTRE DUPL0 20,63mm	1991/1996	SIST. ATE	C-2033	
ELBA		CILINDRO MESTRE DUPL0 20,63mm	1991/1996	SIST. BOSCH	C-2035	
ELBA		REPARO DO CILINDRO MESTRE DUPL0 19,05mm	1986/1991		C-1098	
ELBA		REPARO DO CILINDRO MESTRE DUPL0 20,63mm	1991/1994	P/ CILINDRO BENDIX 2260511S	C-1120	
ELBA		REPARO DO CILINDRO MESTRE DUPL0 20,63mm	1991/1996	SIST. ATE	C-1110	
ELBA		REPARO DO CILINDRO MESTRE DUPL0 20,63mm	1991/1996	SIST. ATE - REPOSIÇÃO	C-1132	
ELBA		REPARO DO CILINDRO MESTRE DUPL0 20,63mm	1991/1996	SIST. BOSCH	C-1142	
ELBA		VEDANTE DO CILINDRO MESTRE	1986/1996		VE-0204	

Tabela de Conversão	Polegadas	9/16"	5/8"	11/16"	7/10"	3/4"	13/16"	7/8"	15/16"	1"	1 1/16"	1 1/8"	1 1/4"	1 3/8"	1 1/2"	1 5/8"	1 3/4"	1 27/32"	2"
	Milímetros		14,28mm	15,87mm	17,46mm	17,78mm	19,05mm	20,63mm	22,22mm	23,81mm	25,40mm	26,98mm	28,57mm	31,75mm	34,92mm	38,10mm	41,27mm	44,45mm	46,83mm

VEÍCULO		DESCRIÇÃO	ANOS	OBSERVAÇÃO	REF.	IMAGEM
<b>FIAT</b>						
ELBA	<-	REPARO DE VEDAÇÃO DA PINÇA 48,00mm	1986/1996	SIST. ATE	C-1443	
ELBA	<-	REPARO DE VEDAÇÃO DA PINÇA 48,00mm	1986/1996	SIST. VARGA	C-1532	
ELBA	<-	TAPA PÓ DO PINO DE GUIA	1986/1996	SIST. VARGA	TA-0322	
ELBA	->	CILINDRO DE RODA 19,05mm	1986/1996		C-3353	
ELBA	->	REPARO DO CILINDRO DE RODA 19,05mm	1986/1996		C-1427	
ELBA	->	GAXETA DO CILINDRO DE RODA 19,05mm	1986/1996		GA-0307	
ELBA	->	TAPA-PÓ DO CILINDRO DE RODA	1986/1996		TA-0303	
ELBA		MANGUEIRA DO FILTRO DE AR	1991/1996		C-9024	
FIORINO (mod. 147)		SERVO FREIO 200mm	1983/1988	SIST. VARGA	C-5630	
FIORINO (mod. 147)		VÁLVULA DE RETENÇÃO DE VÁCUO	1978/1988	SIST. BENDIX	C-1755	
FIORINO (mod. 147)		VÁLVULA DE RETENÇÃO DE VÁCUO BRANCA	1983/1988	P/ SERVO VARGA FD180	C-1750	
FIORINO (mod. 147)		VÁLVULA DE RETENÇÃO DE VÁCUO	1983/1988	SIST. VARGA	C-1753	
FIORINO (mod. 147)		CILINDRO MESTRE DUPLA 19,05mm	1978/1988	SIST. ATE	C-2006	
FIORINO (mod. 147)		CILINDRO MESTRE DUPLA 20,63mm	1983/1988	SIST. VARGA	C-2087	
FIORINO (mod. 147)		REPARO DO CILINDRO MESTRE DUPLA 19,05mm	1978/1988	SIST. ATE	C-1098	
FIORINO (mod. 147)		REPARO DO CILINDRO MESTRE DUPLA 20,63mm	1983/1988	SIST. VARGA	C-1028	
FIORINO (mod. 147)		RESERVATÓRIO C/ TAMPÃO E AVISO DE NÍVEL	1983/1988	SIST. VARGA	C-0102	
FIORINO (mod. 147)		VEDANTE DO CILINDRO MESTRE	1978/1988	SIST. ATE	VE-0204	
FIORINO (mod. 147)		VEDANTE DO CILINDRO MESTRE	1983/1988	SIST. VARGA	VE-0201	
FIORINO (mod. 147)	<-	REPARO DE VEDAÇÃO DA PINÇA 48,00mm	1978/1988	SIST. BENDIX	C-1421	
FIORINO (mod. 147)	<-	REPARO DE VEDAÇÃO DA PINÇA 48,00mm	1981/1988	SIST. ATE (2 RODAS)	C-1434	
FIORINO (mod. 147)	->	CILINDRO DE RODA 19,05mm	1978/1988		C-3355	
FIORINO (mod. 147)	->	REPARO DO CILINDRO DE RODA 19,05mm	1978/1988	P/ CILINDRO BENDIX	C-1424	
FIORINO (mod. 147)	->	REPARO DO CILINDRO DE RODA 19,05mm	1978/1988		C-1427	
FIORINO (mod. 147)	->	COPO DO CILINDRO DE RODA 19,05mm	1978/1988	P/ CILINDRO BENDIX	CO-1312	
FIORINO (mod. 147)	->	GAXETA DO CILINDRO DE RODA 19,05mm	1978/1988		GA-0307	
FIORINO (mod. 147)	->	TAPA-PÓ DO CILINDRO DE RODA	1978/1988		TA-0303	
FIORINO (mod. 147)	->	TAPA-PÓ DO CILINDRO DE RODA	1978/1988	P/ CILINDRO BENDIX	TA-0310	
FIORINO (mod. Uno)		SERVO FREIO 200mm	1992/1993	SIST. ATE E BOSCH	C-5613	

Tabela de Conversão	Polegadas	9/16"	5/8"	11/16"	7/10"	3/4"	13/16"	7/8"	15/16"	1"	1 1/16"	1 1/8"	1 1/4"	1 3/8"	1 1/2"	1 5/8"	1 3/4"	1 27/32"	2"
	Milímetros	14,28mm	15,87mm	17,46mm	17,78mm	19,05mm	20,63mm	22,22mm	23,81mm	25,40mm	26,98mm	28,57mm	31,75mm	34,92mm	38,10mm	41,27mm	44,45mm	46,83mm	50,80mm



VEÍCULO		DESCRIÇÃO	ANOS	OBSERVAÇÃO	REF.	IMAGEM
<b>FIAT</b>						
FIORINO (mod. Uno)		SERVO FREIO 200mm	1994/...	SIST. ATE E BOSCH	C-5629	
FIORINO (mod. Uno)		VÁLVULA DE RETENÇÃO DE VÁCUO	1988/...		C-1755	
FIORINO (mod. Uno)		CILINDRO MESTRE DUPL0 19,05mm	1988/1991		C-2030	
FIORINO (mod. Uno)		CILINDRO MESTRE DUPL0 20,63mm	1991/1993	SIST. ATE	C-2033	
FIORINO (mod. Uno)		CILINDRO MESTRE DUPL0 20,63mm	1991/1993	SIST. BOSCH	C-2035	
FIORINO (mod. Uno)		CILINDRO MESTRE DUPL0 22,22mm	1994/...	SIST. BOSCH	C-2042	
FIORINO (mod. Uno)		CILINDRO MESTRE DUPL0 22,22mm	1994/...	SIST. ATE	C-2075	
FIORINO (mod. Uno)		REPARO DO CILINDRO MESTRE DUPL0 19,05mm	1988/1991		C-1098	
FIORINO (mod. Uno)		REPARO DO CILINDRO MESTRE DUPL0 20,63mm	1991/1993	SIST. ATE	C-1110	
FIORINO (mod. Uno)		REPARO DO CILINDRO MESTRE DUPL0 20,63mm	1991/1993	P/ CILINDRO BENDIX 2260511S	C-1120	
FIORINO (mod. Uno)		REPARO DO CILINDRO MESTRE DUPL0 20,63mm	1991/1993	SIST. ATE - REPOSIÇÃO	C-1132	
FIORINO (mod. Uno)		REPARO DO CILINDRO MESTRE DUPL0 20,63mm	1991/1993	SIST. BOSCH	C-1142	
FIORINO (mod. Uno)		REPARO DO CILINDRO MESTRE DUPL0 22,22mm	1994/...	SIST. BOSCH	C-1119	
FIORINO (mod. Uno)		REPARO DO CILINDRO MESTRE DUPL0 22,22mm	1994/...	SIST. ATE	C-1152	
FIORINO (mod. Uno)		REPARO DO CILINDRO MESTRE DUPL0 22,22mm	1994/1994	P/ CILINDRO BENDIX 2261700S	C-1118	
FIORINO (mod. Uno)		VEDANTE DO CILINDRO MESTRE	1988/...		VE-0204	
FIORINO (mod. Uno)	<-	REPARO DE VEDAÇÃO DA PINÇA 48,00mm	1988/1993	SIST. ATE	C-1443	
FIORINO (mod. Uno)	<-	REPARO DE VEDAÇÃO DA PINÇA 48,00mm	1988/1993	SIST. VARGA	C-1532	
FIORINO (mod. Uno)	<-	REPARO DE VEDAÇÃO DA PINÇA 54,00mm	1994/...		C-1419	
FIORINO (mod. Uno)	<-	TAPA PÓ DO PINO DE GUIA	1988/1993	SIST. VARGA	TA-0322	
FIORINO (mod. Uno)	->	CILINDRO DE RODA 19,05mm	1988/1993		C-3353	
FIORINO (mod. Uno)	->	CILINDRO DE RODA 20,63mm	1994/...		C-3411	
FIORINO (mod. Uno)	->	REPARO DO CILINDRO DE RODA 19,05mm	1988/1993		C-1427	
FIORINO (mod. Uno)	->	REPARO DO CILINDRO DE RODA 20,63mm	1994/...		C-1534	
FIORINO (mod. Uno)	->	GAXETA DO CILINDRO DE RODA 19,05mm	1988/1993		GA-0307	
FIORINO (mod. Uno)	->	COPO DO CILINDRO DE RODA 20,63mm	1994/...		CO-1317	

Tabela de Conversão	Polegadas	9/16"	5/8"	11/16"	7/10"	3/4"	13/16"	7/8"	15/16"	1"	1 1/16"	1 1/8"	1 1/4"	1 3/8"	1 1/2"	1 5/8"	1 3/4"	1 27/32"	2"
	Milímetros	14,28mm	15,87mm	17,46mm	17,78mm	19,05mm	20,63mm	22,22mm	23,81mm	25,40mm	26,98mm	28,57mm	31,75mm	34,92mm	38,10mm	41,27mm	44,45mm	46,83mm	50,80mm

VEÍCULO		DESCRIÇÃO	ANOS	OBSERVAÇÃO	REF.	IMAGEM
<b>FIAT</b>						
FIORINO (mod. Uno)	->	TAPA-PÓ DO CILINDRO DE RODA	1988/1993		TA-0303	
FIORINO (mod. Uno)	->	TAPA-PÓ DO CILINDRO DE RODA	1994/...		TA-0321	
FIORINO (mod. Uno)		MANGUEIRA DO FILTRO DE AR	1989/1996		C-9024	
FIORINO (mod. Uno)		MANGUEIRA DO FILTRO DE AR	1992/2004	1.5 8V BOCAL MAIOR PARA SENSOR	C-9026	
FIORINO (mod. Uno)		MANGUEIRA DO FILTRO DE AR	1996	1.0 8V	C-9024	
FIORINO (mod. Uno)		MANGUEIRA DO FILTRO DE AR	1997/2004	BOCAL MENOR PARA SENSOR	C-9025	
FIORINO (mod. Uno)		MANGUEIRA DO FILTRO DE AR	2003/2004	1.3 8V / BOCAL MENOR PARA SENSOR	C-9025	
FIORINO (mod. Uno)		MANGUEIRA DO FILTRO DE AR	2003/2004	BOCAL MAIOR PARA SENSOR	C-9026	
FIORINO (mod. Uno)		MANGUEIRA DO FILTRO DE AR	2003/2007	MOTOR 1.3 FIRE 8V	C-9004	
FIORINO (mod. Uno)		MANGUEIRA DE AR DO CORPO DA BORBOLETA	2003/...	MOTOR 1.3 FIRE/FIRE FLEX 8V	C-9011	
FIORINO (mod. Uno)		MANGUEIRA DO RESPIRO DO MOTOR	1985/2004		C-9023	
FIORINO (mod. Uno)		JOGO ANÉIS VEDAÇÃO COLETOR DE ADMISSÃO	2003/...	MOTOR 1.3 FIRE/FIRE FLEX 8V	C-9504	
GRAND SIENA	->	CILINDRO DE RODA 20,63mm	2012/...		C-3478	
GRAND SIENA	->	REPARO DO CILINDRO DE RODA 20,63mm	2012/...		C-1578	
GRAND SIENA	->	GAXETA DO CILINDRO DE RODA 20,63mm	2012/...		GA-0206	
GRAND SIENA	->	TAPA-PÓ DO CILINDRO DE RODA	2012/...		TA-0312	
IDEA		CILINDRO MESTRE DE EMBREAGEM 15,87mm	2006/...		C-2647	

Tabela de Conversão	Polegadas	9/16"	5/8"	11/16"	7/10"	3/4"	13/16"	7/8"	15/16"	1"	1 1/16"	1 1/8"	1 1/4"	1 3/8"	1 1/2"	1 5/8"	1 3/4"	1 27/32"	2"
	Milímetros	14,28mm	15,87mm	17,46mm	17,78mm	19,05mm	20,63mm	22,22mm	23,81mm	25,40mm	26,98mm	28,57mm	31,75mm	34,92mm	38,10mm	41,27mm	44,45mm	46,83mm	50,80mm

VEÍCULO		DESCRIÇÃO	ANOS	OBSERVAÇÃO	REF.	IMAGEM
<b>FIAT</b>						
IDEA		CIL. ATUADOR CONCÊNTRICO DE EMBREAGEM	2005/...	MOTOR 1.8 8V / EtorQ 1.8 16V	C-2712	
IDEA		CILINDRO AUXILIAR DE EMBREAGEM 22,22mm	2006/...	MOTOR 1.4	C-2648	
IDEA		SERVO FREIO 230mm	2006/...	MOTOR 1.4	C-5657	
IDEA		CILINDRO MESTRE DUPLA 22,22mm	2006/...	S/ABS	C-2176	
IDEA	<-	REPARO DE VEDAÇÃO DA PINÇA 54,00mm	2006/...		C-1419	
IDEA	->	CILINDRO DE RODA 20,63mm	2006/...		C-3411	
IDEA	->	REPARO DO CILINDRO DE RODA 20,63mm	2006/...		C-1534	
IDEA	->	COPO DO CILINDRO DE RODA 20,63mm	2006/...		CO-1317	
IDEA	->	TAPA-PÓ DO CILINDRO DE RODA	2006/...		TA-0321	
IDEA		MANGUEIRA DO FILTRO DE AR	2006/...	MOTOR 1.4 FIRE FLEX 8V	C-9002	
IDEA		JOGO ANÉIS VEDAÇÃO COLETOR DE ADMISSÃO	2006/...	MOTOR 1.4 FIRE FLEX 8V	C-9505	
IDEA		JOGO ANÉIS VEDAÇÃO COLETOR DE ADMISSÃO	2007/...	MOTOR 1.8 FLEX 8V	C-9501	
LINEA	<-	REPARO DE VEDAÇÃO DA PINÇA 54,00mm	2007/...		C-1419	
MAREA		CILINDRO MESTRE DUPLA 23,81mm	1999/2007	MOTOR 2.0/2.4 20V	C-2142	
MAREA		CILINDRO MESTRE DUPLA 23,81mm	1999/2007	MOTOR 2.0 TURBO 20V	C-2142	

Tabela de Conversão	Polegadas	9/16"	5/8"	11/16"	7/10"	3/4"	13/16"	7/8"	15/16"	1"	1 1/16"	1 1/8"	1 1/4"	1 3/8"	1 1/2"	1 5/8"	1 3/4"	1 27/32"	2"
	Milímetros	14,28mm	15,87mm	17,46mm	17,78mm	19,05mm	20,63mm	22,22mm	23,81mm	25,40mm	26,98mm	28,57mm	31,75mm	34,92mm	38,10mm	41,27mm	44,45mm	46,83mm	50,80mm

VEÍCULO		DESCRIÇÃO	ANOS	OBSERVAÇÃO	REF.	IMAGEM
<b>FIAT</b>						
MAREA		CILINDRO MESTRE DUPL0 23,81mm	2000/2007	MOTOR 1.8 16V	C-2142	
MAREA		CILINDRO MESTRE DUPL0 22,22mm	2006/2007	MOTOR 1.6 16V S/ABS	C-2053	
MAREA		VEDANTE DO CILINDRO MESTRE	1999/2007		VE-0204	
MAREA	->	CILINDRO DE RODA 20,63mm	2000/2007		C-3411	
MAREA	->	REPARO DO CILINDRO DE RODA 20,63mm	2000/2007		C-1534	
MAREA	->	COPO DO CILINDRO DE RODA 20,63mm	2000/2007		CO-1317	
MAREA	->	TAPA-PÓ DO CILINDRO DE RODA	2000/2007		TA-0321	
MAREA	->	REPARO DE VEDAÇÃO DA PINÇA 34,00mm	1999/2007		C-1537	
MAREA WEEKEND		CILINDRO MESTRE DUPL0 23,81mm	1999/2007	MOTOR 2.0/2.4 20V	C-2142	
MAREA WEEKEND		CILINDRO MESTRE DUPL0 23,81mm	1999/2007	MOTOR 2.0 TURBO 20V	C-2142	
MAREA WEEKEND		CILINDRO MESTRE DUPL0 23,81mm	2000/2007	MOTOR 1.8 16V	C-2142	
MAREA WEEKEND		CILINDRO MESTRE DUPL0 22,22mm	2006/2007	MOTOR 1.6 16V S/ABS	C-2053	
MAREA WEEKEND		VEDANTE DO CILINDRO MESTRE	1999/2007		VE-0204	
MAREA WEEKEND	->	CILINDRO DE RODA 20,63mm	2000/2007		C-3411	
MAREA WEEKEND	->	REPARO DO CILINDRO DE RODA 20,63mm	2000/2007		C-1534	
MAREA WEEKEND	->	COPO DO CILINDRO DE RODA 20,63mm	2000/2007		CO-1317	
MAREA WEEKEND	->	TAPA-PÓ DO CILINDRO DE RODA	2000/2007		TA-0321	
MAREA WEEKEND	->	REPARO DE VEDAÇÃO DA PINÇA 34,00mm	1999/2007		C-1537	
OGGI		SERVO FREIO 200mm	1983/1985	SIST. VARGA	C-5630	
OGGI		VÁLVULA DE RETENÇÃO DE VÁCUO BRANCA	1983/1985	P/ SERVO VARGA FD180	C-1750	
OGGI		VÁLVULA DE RETENÇÃO DE VÁCUO	1983/1985	SIST. VARGA	C-1753	

Tabela de Conversão	Polegadas	9/16"	5/8"	11/16"	7/10"	3/4"	13/16"	7/8"	15/16"	1"	1 1/16"	1 1/8"	1 1/4"	1 3/8"	1 1/2"	1 5/8"	1 3/4"	1 27/32"	2"
	Milímetros	14,28mm	15,87mm	17,46mm	17,78mm	19,05mm	20,63mm	22,22mm	23,81mm	25,40mm	26,98mm	28,57mm	31,75mm	34,92mm	38,10mm	41,27mm	44,45mm	46,83mm	50,80mm

VEÍCULO		DESCRIÇÃO	ANOS	OBSERVAÇÃO	REF.	IMAGEM
<b>FIAT</b>						
OGGI		VÁLVULA DE RETENÇÃO DE VÁCUO	1983/1985	SIST. BENDIX	C-1755	
OGGI		CILINDRO MESTRE DUPL0 19,05mm	1983/1985	SIST. ATE	C-2006	
OGGI		CILINDRO MESTRE DUPL0 20,63mm	1983/1985	SIST. VARGA	C-2087	
OGGI		REPARO DO CILINDRO MESTRE DUPL0 20,63mm	1983/1985	SIST. VARGA	C-1028	
OGGI		REPARO DO CILINDRO MESTRE DUPL0 19,05mm	1983/1985	SIST. ATE	C-1098	
OGGI		RESERVATÓRIO C/ TAMP A E AVISO DE NÍVEL	1983/1985	SIST. VARGA	C-0102	
OGGI		VEDANTE DO CILINDRO MESTRE	1983/1985	SIST. VARGA	VE-0201	
OGGI		VEDANTE DO CILINDRO MESTRE	1983/1985	SIST. ATE	VE-0204	
OGGI	<-	REPARO DE VEDAÇÃO DA PINÇA 48,00mm	1983/1985	SIST. BENDIX	C-1421	
OGGI	<-	REPARO DE VEDAÇÃO DA PINÇA 48,00mm	1983/1985	SIST. ATE (2 RODAS)	C-1434	
OGGI	->	CILINDRO DE RODA 19,05mm	1983/1985		C-3355	
OGGI	->	REPARO DO CILINDRO DE RODA 19,05mm	1983/1985	P/ CILINDRO BENDIX	C-1424	
OGGI	->	REPARO DO CILINDRO DE RODA 19,05mm	1983/1985		C-1427	
OGGI	->	COPO DO CILINDRO DE RODA 19,05mm	1983/1985	P/ CILINDRO BENDIX	CO-1312	
OGGI	->	GAXETA DO CILINDRO DE RODA 19,05mm	1983/1985		GA-0307	
OGGI	->	TAPA-PÓ DO CILINDRO DE RODA	1983/1985		TA-0303	
OGGI	->	TAPA-PÓ DO CILINDRO DE RODA	1983/1985	P/ CILINDRO BENDIX	TA-0310	
PALIO		CILINDRO MESTRE DE EMBREAGEM 15,87mm	2001/...	MOTOR 1.0/1.3/1.4/1.6	C-2647	
PALIO		CILINDRO MESTRE DE EMBREAGEM 15,87mm	2006/...	MOTOR 1.8 SIST. LUK	C-2647	
PALIO		CILINDRO AUXILIAR DE EMBREAGEM 22,22mm	2001/...	MOTOR 1.0/1.3/1.4/1.6	C-2648	
PALIO		CIL. ATUADOR CONCÊNTRICO DE EMBREAGEM	2005/...	MOTOR 1.8 8V / EtorQ 1.8 16V	C-2712	
PALIO		SERVO FREIO 200mm	1996/1997	S/ABS	C-5631	

Tabela de Conversão	Polegadas	9/16"	5/8"	11/16"	7/10"	3/4"	13/16"	7/8"	15/16"	1"	1 1/16"	1 1/8"	1 1/4"	1 3/8"	1 1/2"	1 5/8"	1 3/4"	1 27/32"	2"
	Milímetros	14,28mm	15,87mm	17,46mm	17,78mm	19,05mm	20,63mm	22,22mm	23,81mm	25,40mm	26,98mm	28,57mm	31,75mm	34,92mm	38,10mm	41,27mm	44,45mm	46,83mm	50,80mm

VEÍCULO		DESCRIÇÃO	ANOS	OBSERVAÇÃO	REF.	IMAGEM
<b>FIAT</b>						
PALIO		SERVO FREIO 200mm	1996/1997	C/ABS	C-5651	
PALIO		SERVO FREIO 230mm	1998/1999	SIST. ATE E BOSCH S/ABS	C-5636	
PALIO		SERVO FREIO 230mm	1998/1999	C/ABS	C-5653	
PALIO		SERVO FREIO 230mm	2000/...	SIST. ATE E BOSCH S/ABS	C-5656	
PALIO		SERVO FREIO 230mm	2000/...	C/ABS	C-5657	
PALIO		CILINDRO MESTRE DUPL0 20,63mm	1996/1998	S/ABS	C-2046	
PALIO		CILINDRO MESTRE DUPL0 22,22mm	1998/...	SIST. BOSCH S/ABS	C-2042	
PALIO		CILINDRO MESTRE DUPL0 22,22mm	1998/...	SIST. ATE S/ABS	C-2075	
PALIO		REPARO DO CILINDRO MESTRE DUPL0 20,63mm	1996/1998	S/ABS	C-1132	
PALIO		REPARO DO CILINDRO MESTRE DUPL0 22,22mm	1998/...	SIST. BOSCH S/ABS	C-1119	
PALIO		REPARO DO CILINDRO MESTRE DUPL0 22,22mm	1998/...	SIST. ATE S/ABS	C-1152	
PALIO		VEDANTE DO CILINDRO MESTRE	1996/...		VE-0204	
PALIO	<	REPARO DE VEDAÇÃO DA PINÇA 48,00mm	1996/1998		C-1443	
PALIO	<	REPARO DE VEDAÇÃO DA PINÇA 54,00mm	1998/...		C-1419	
PALIO	>	CILINDRO DE RODA 19,05mm	1996/1998		C-3437	
PALIO	>	CILINDRO DE RODA 19,05mm	1999/2011	S/ABS	C-3472	

Tabela de Conversão	Polegadas	9/16"	5/8"	11/16"	7/10"	3/4"	13/16"	7/8"	15/16"	1"	1 1/16"	1 1/8"	1 1/4"	1 3/8"	1 1/2"	1 5/8"	1 3/4"	1 27/32"	2"
	Milímetros	14,28mm	15,87mm	17,46mm	17,78mm	19,05mm	20,63mm	22,22mm	23,81mm	25,40mm	26,98mm	28,57mm	31,75mm	34,92mm	38,10mm	41,27mm	44,45mm	46,83mm	50,80mm













VEÍCULO		DESCRIÇÃO	ANOS	OBSERVAÇÃO	REF.	IMAGEM
<b>FIAT</b>						
PALIO	->	CILINDRO DE RODA 20,63mm	1999/2011	C/ABS	C-3496	
PALIO	->	CILINDRO DE RODA 19,05mm	2012/...	ATTRACTIVE 1.0 8V	C-3427	
PALIO	->	CILINDRO DE RODA 19,05mm	2012/...	ELX 1.0 8V	C-3427	
PALIO	->	CILINDRO DE RODA 19,05mm	2012/...	ESSENCE 1.6 16V	C-3427	
PALIO	->	CILINDRO DE RODA 19,05mm	2012/...	FIRE 1.0 8V	C-3427	
PALIO	->	CILINDRO DE RODA 19,05mm	2012/...	SPORTING 1.6 16V	C-3427	
PALIO	->	CILINDRO DE RODA 20,63mm	2012/...	ATTRACTIVE 1.4 8V	C-3428	
PALIO	->	CILINDRO DE RODA 22,22mm	2012/...	1.0 COM ABS	C-3429	
PALIO	->	CILINDRO DE RODA 22,22mm	2012/...	1.6 16V	C-3429	
PALIO	->	CILINDRO DE RODA 22,22mm	2012/...	1.4	C-3429	
PALIO	->	CILINDRO DE RODA 19,05mm	2012/...	MOD. FIRE S/ABS	C-3472	

Tabela de Conversão	Polegadas	9/16"	5/8"	11/16"	7/10"	3/4"	13/16"	7/8"	15/16"	1"	1 1/16"	1 1/8"	1 1/4"	1 3/8"	1 1/2"	1 5/8"	1 3/4"	1 27/32"	2"
	Milímetros	14,28mm	15,87mm	17,46mm	17,78mm	19,05mm	20,63mm	22,22mm	23,81mm	25,40mm	26,98mm	28,57mm	31,75mm	34,92mm	38,10mm	41,27mm	44,45mm	46,83mm	50,80mm

VEÍCULO		DESCRIÇÃO	ANOS	OBSERVAÇÃO	REF.	IMAGEM
<b>FIAT</b>						
PALIO	->	CILINDRO DE RODA 20,63mm	2012/...	SIST. TRW	C-3478	
PALIO	->	CILINDRO DE RODA 20,63mm	2012/...	MOD. FIRE C/ABS	C-3496	
PALIO	->	REPARO DO CILINDRO DE RODA 19,05mm	1996/1998		C-1556	
PALIO	->	REPARO DO CILINDRO DE RODA 20,63mm	1999/2011	C/ABS	C-1555	
PALIO	->	REPARO DO CILINDRO DE RODA 19,05mm	1999/2011	S/ABS	C-1556	
PALIO	->	REPARO DO CILINDRO DE RODA 20,63mm	2012/...	MOD. FIRE C/ABS	C-1555	
PALIO	->	REPARO DO CILINDRO DE RODA 19,05mm	2012/...	MOD. FIRE S/ABS	C-1556	
PALIO	->	REPARO DO CILINDRO DE RODA 20,63mm	2012/...	SIST. TRW	C-1578	
PALIO	->	GAXETA DO CILINDRO DE RODA 19,05mm	1996/1998		GA-0320	
PALIO	->	GAXETA DO CILINDRO DE RODA 20,63mm	1999/2011	C/ABS	GA-0217	
PALIO	->	GAXETA DO CILINDRO DE RODA 19,05mm	1999/2011	S/ABS	GA-0320	
PALIO	->	GAXETA DO CILINDRO DE RODA 20,63mm	2012/...	SIST. TRW	GA-0206	
PALIO	->	GAXETA DO CILINDRO DE RODA 20,63mm	2012/...	MOD. FIRE C/ABS	GA-0217	
PALIO	->	GAXETA DO CILINDRO DE RODA 19,05mm	2012/...	MOD. FIRE S/ABS	GA-0320	
PALIO	->	TAPA-PÓ DO CILINDRO DE RODA	1996/2011		TA-0303	
PALIO	->	TAPA-PÓ DO CILINDRO DE RODA	2012/...	MOD. FIRE	TA-0303	
PALIO	->	TAPA-PÓ DO CILINDRO DE RODA	2012/...	SIST. TRW	TA-0312	
PALIO		MANGUEIRA DO FILTRO DE AR	1996/2000	MOTOR 1.6 16V	C-9006	
PALIO		MANGUEIRA DO FILTRO DE AR	1996/2000	MOTOR 1.0	C-9016	
PALIO		MANGUEIRA DO FILTRO DE AR	1996/2004	MOTOR 1.5 (SAIDA MAIOR)	C-9014	
PALIO		MANGUEIRA DO FILTRO DE AR	1996/2004	MOTOR 1.5 (SAIDA MENOR)	C-9015	
PALIO		MANGUEIRA DO FILTRO DE AR	1998/2000	MOTOR 1.6 8V	C-9005	
PALIO		MANGUEIRA DO FILTRO DE AR	2001/2003	MOTOR 1.0/1.3 FIRE 16V	C-9012	

BUSCA POR VEÍCULOS

Tabela de Conversão	Polegadas	9/16"	5/8"	11/16"	7/10"	3/4"	13/16"	7/8"	15/16"	1"	1 1/16"	1 1/8"	1 1/4"	1 3/8"	1 1/2"	1 5/8"	1 3/4"	1 27/32"	2"
	Milímetros	14,28mm	15,87mm	17,46mm	17,78mm	19,05mm	20,63mm	22,22mm	23,81mm	25,40mm	26,98mm	28,57mm	31,75mm	34,92mm	38,10mm	41,27mm	44,45mm	46,83mm	50,80mm



VEÍCULO		DESCRIÇÃO	ANOS	OBSERVAÇÃO	REF.	IMAGEM
<b>FIAT</b>						
PALIO		MANGUEIRA DO FILTRO DE AR	2001/2003	1.3 8V BOCAL MAIOR PARA SENSOR	C-9026	
PALIO		MANGUEIRA DO FILTRO DE AR	2001/2003	MOTOR 1.6 16V	C-9028	
PALIO		MANGUEIRA DO FILTRO DE AR	2001/2004	MOTOR 1.0 FIRE 8V	C-9001	
PALIO		MANGUEIRA DO FILTRO DE AR	2003/2003	BOCAL MENOR PARA SENSOR	C-9025	
PALIO		MANGUEIRA DO FILTRO DE AR	2003/2006	MOTOR 1.3 FIRE 8V	C-9001	
PALIO		MANGUEIRA DO FILTRO DE AR	2004/2006	MOTOR 1.0 FIRE 8V	C-9003	
PALIO		MANGUEIRA DO FILTRO DE AR	2006/...	MOTOR 1.0 FIRE FLEX 8V	C-9001	
PALIO		MANGUEIRA DO FILTRO DE AR	2006/...	MOTOR 1.4 FIRE FLEX 8V	C-9002	
PALIO		MANGUEIRA DE AR DO CORPO DA BORBOLETA	2001/2003	MOTOR 1.0/1.3 FIRE 16V	C-9007	
PALIO		MANGUEIRA DE AR DO CORPO DA BORBOLETA	2003/...	MOTOR 1.0/1.3 FIRE/FIRE FLEX 8V	C-9011	
PALIO		MANGUEIRA DO RESPIRO DO MOTOR	1996/2002		C-9022	
PALIO		JOGO ANÉIS VEDAÇÃO COLETOR DE ADMISSÃO	2001/2004	MOTOR 1.0/1.3 FIRE 8V	C-9504	

Tabela de Conversão	Polegadas	9/16"	5/8"	11/16"	7/10"	3/4"	13/16"	7/8"	15/16"	1"	1 1/16"	1 1/8"	1 1/4"	1 3/8"	1 1/2"	1 5/8"	1 3/4"	1 27/32"	2"
	Milímetros		14,28mm	15,87mm	17,46mm	17,78mm	19,05mm	20,63mm	22,22mm	23,81mm	25,40mm	26,98mm	28,57mm	31,75mm	34,92mm	38,10mm	41,27mm	44,45mm	46,83mm





















VEÍCULO		DESCRIÇÃO	ANOS	OBSERVAÇÃO	REF.	IMAGEM
<b>FIAT</b>						
PALIO		JOGO ANÉIS VEDAÇÃO COLETOR DE ADMISSÃO	2004/2005	MOTOR 1.3 FIRE FLEX 8V	C-9504	
PALIO		JOGO ANÉIS VEDAÇÃO COLETOR DE ADMISSÃO	2004/2006	MOTOR 1.0 FIRE 8V	C-9507	
PALIO		JOGO ANÉIS VEDAÇÃO COLETOR DE ADMISSÃO	2006/...	MOD. 1.8 R	C-9501	
PALIO		JOGO ANÉIS VEDAÇÃO COLETOR DE ADMISSÃO	2006/...	MOTOR 1.0 FIRE FLEX 8V	C-9504	
PALIO		JOGO ANÉIS VEDAÇÃO COLETOR DE ADMISSÃO	2006/...	MOTOR 1.4 FIRE FLEX 8V	C-9505	
PALIO		JOGO ANÉIS VEDAÇÃO COLETOR DE ADMISSÃO	2007/...	MOTOR 1.8 FLEX 8V	C-9501	
PALIO WAY	->	CILINDRO DE RODA 20,63mm	2012/...	FIRE 1.0	C-3428	
PALIO WEEKEND		CILINDRO MESTRE DE EMBREAGEM 15,87mm	2001/...	MOTOR 1.0/1.3/1.4/1.6	C-2647	
PALIO WEEKEND		CILINDRO MESTRE DE EMBREAGEM 15,87mm	2005/...	MOTOR 1.8 SIST. LUK	C-2647	
PALIO WEEKEND		CILINDRO AUXILIAR DE EMBREAGEM 22,22mm	2001/...	MOTOR 1.0/1.3/1.4/1.6	C-2648	
PALIO WEEKEND		SERVO FREIO 200mm	1997/1997	S/ABS	C-5631	

Tabela de Conversão	Polegadas	9/16"	5/8"	11/16"	7/10"	3/4"	13/16"	7/8"	15/16"	1"	1 1/16"	1 1/8"	1 1/4"	1 3/8"	1 1/2"	1 5/8"	1 3/4"	1 27/32"	2"
	Milímetros	14,28mm	15,87mm	17,46mm	17,78mm	19,05mm	20,63mm	22,22mm	23,81mm	25,40mm	26,98mm	28,57mm	31,75mm	34,92mm	38,10mm	41,27mm	44,45mm	46,83mm	50,80mm

VEÍCULO		DESCRIÇÃO	ANOS	OBSERVAÇÃO	REF.	IMAGEM
<b>FIAT</b>						
PALIO WEEKEND		SERVO FREIO 200mm	1997/1997	C/ABS	C-5651	
PALIO WEEKEND		SERVO FREIO 230mm	1998/1999	SIST. ATE E BOSCH S/ABS	C-5636	
PALIO WEEKEND		SERVO FREIO 230mm	1998/1999	C/ABS	C-5653	
PALIO WEEKEND		SERVO FREIO 230mm	2000/...	SIST. ATE E BOSCH S/ABS	C-5656	
PALIO WEEKEND		SERVO FREIO 230mm	2000/...	C/ABS	C-5657	
PALIO WEEKEND		CILINDRO MESTRE DUPL0 20,63mm	1997/1998	MOTOR 1.5 S/ABS	C-2046	
PALIO WEEKEND		CILINDRO MESTRE DUPL0 22,22mm	1997/1998	MOTOR 1.6 16V S/ABS	C-2075	
PALIO WEEKEND		CILINDRO MESTRE DUPL0 22,22mm	1998/...	SIST. BOSCH S/ABS	C-2042	
PALIO WEEKEND		CILINDRO MESTRE DUPL0 22,22mm	1998/...	SIST. ATE S/ABS	C-2075	
PALIO WEEKEND		REPARO DO CILINDRO MESTRE DUPL0 20,63mm	1997/1998	MOTOR 1.5 S/ABS	C-1132	
PALIO WEEKEND		REPARO DO CILINDRO MESTRE DUPL0 22,22mm	1997/1998	MOTOR 1.6 16V S/ABS	C-1152	
PALIO WEEKEND		REPARO DO CILINDRO MESTRE DUPL0 22,22mm	1998/...	SIST. BOSCH S/ABS	C-1119	
PALIO WEEKEND		REPARO DO CILINDRO MESTRE DUPL0 22,22mm	1998/...	SIST. ATE S/ABS	C-1152	
PALIO WEEKEND		VEDANTE DO CILINDRO MESTRE	1997/...		VE-0204	
PALIO WEEKEND	<	REPARO DE VEDAÇÃO DA PINÇA 54,00mm	1997/1998	MOTOR 1.6 16V	C-1419	
PALIO WEEKEND	<	REPARO DE VEDAÇÃO DA PINÇA 48,00mm	1997/1998	MOTOR 1.5	C-1443	
PALIO WEEKEND	<	REPARO DE VEDAÇÃO DA PINÇA 54,00mm	1998/...		C-1419	

Tabela de Conversão	Polegadas	9/16"	5/8"	11/16"	7/10"	3/4"	13/16"	7/8"	15/16"	1"	1 1/16"	1 1/8"	1 1/4"	1 3/8"	1 1/2"	1 5/8"	1 3/4"	1 27/32"	2"
	Milímetros	14,28mm	15,87mm	17,46mm	17,78mm	19,05mm	20,63mm	22,22mm	23,81mm	25,40mm	26,98mm	28,57mm	31,75mm	34,92mm	38,10mm	41,27mm	44,45mm	46,83mm	50,80mm

VEÍCULO		DESCRIÇÃO	ANOS	OBSERVAÇÃO	REF.	IMAGEM
<b>FIAT</b>						
PALIO WEEKEND	->	CILINDRO DE RODA 20,63mm	1997/2008	EXCETO LOCKER	C-3411	
PALIO WEEKEND	->	CILINDRO DE RODA 20,63mm	2009/...	SIST. BOSCH	C-3411	
PALIO WEEKEND	->	CILINDRO DE RODA 20,63mm	2009/...	SIST. TRW	C-3478	
PALIO WEEKEND	->	CILINDRO DE RODA 19,05mm	2012/...	ESSENCE 1.6 16V	C-3427	
PALIO WEEKEND	->	CILINDRO DE RODA 19,05mm	2012/...	TREKKING 1.6 16V	C-3427	
PALIO WEEKEND	->	CILINDRO DE RODA 20,63mm	2012/...	ADVENTURE 1.8	C-3428	
PALIO WEEKEND	->	CILINDRO DE RODA 20,63mm	2012/...	ATTRACTIVE 1.4	C-3428	
PALIO WEEKEND	->	REPARO DO CILINDRO DE RODA 20,63mm	1997/2008		C-1534	
PALIO WEEKEND	->	REPARO DO CILINDRO DE RODA 20,63mm	2009/...	SIST. BOSCH	C-1534	
PALIO WEEKEND	->	REPARO DO CILINDRO DE RODA 20,63mm	2009/...	SIST. TRW	C-1578	
PALIO WEEKEND	->	COPO DO CILINDRO DE RODA 20,63mm	1997/2008		CO-1317	
PALIO WEEKEND	->	COPO DO CILINDRO DE RODA 20,63mm	2009/...	SIST. BOSCH	CO-1317	
PALIO WEEKEND	->	GAXETA DO CILINDRO DE RODA 20,63mm	2009/...	SIST. TRW	GA-0206	
PALIO WEEKEND	->	TAPA-PÓ DO CILINDRO DE RODA	1997/2008		TA-0321	
PALIO WEEKEND	->	TAPA-PÓ DO CILINDRO DE RODA	2009/...	SIST. TRW	TA-0312	
PALIO WEEKEND	->	TAPA-PÓ DO CILINDRO DE RODA	2009/...	SIST. BOSCH	TA-0321	
PALIO WEEKEND		MANGUEIRA DO FILTRO DE AR	1997/2000	MOTOR 1.6 16V	C-9006	
PALIO WEEKEND		MANGUEIRA DO FILTRO DE AR	1997/2004	MOTOR 1.5 (SAIDA MAIOR)	C-9014	

BUSCA POR VEÍCULOS

Tabela de Conversão	Polegadas	9/16"	5/8"	11/16"	7/10"	3/4"	13/16"	7/8"	15/16"	1"	1 1/16"	1 1/8"	1 1/4"	1 3/8"	1 1/2"	1 5/8"	1 3/4"	1 27/32"	2"
	Milímetros	14,28mm	15,87mm	17,46mm	17,78mm	19,05mm	20,63mm	22,22mm	23,81mm	25,40mm	26,98mm	28,57mm	31,75mm	34,92mm	38,10mm	41,27mm	44,45mm	46,83mm	50,80mm

VEÍCULO		DESCRIÇÃO	ANOS	OBSERVAÇÃO	REF.	IMAGEM
<b>FIAT</b>						
PALIO WEEKEND		MANGUEIRA DO FILTRO DE AR	1997/2004	MOTOR 1.5 (SAIDA MENOR)	C-9015	
PALIO WEEKEND		MANGUEIRA DO FILTRO DE AR	1999/2000	MOTOR 1.6 8V	C-9005	
PALIO WEEKEND		MANGUEIRA DO FILTRO DE AR	2001/2003	MOTOR 1.0/1.3 FIRE 16V	C-9012	
PALIO WEEKEND		MANGUEIRA DO FILTRO DE AR	2001/2003	MOTOR 1.6 16V	C-9028	
PALIO WEEKEND		MANGUEIRA DO FILTRO DE AR	2003/2005	MOTOR 1.3 FIRE 8V	C-9001	
PALIO WEEKEND		MANGUEIRA DO FILTRO DE AR	2006/...	MOTOR 1.4 FIRE FLEX 8V	C-9002	
PALIO WEEKEND		MANGUEIRA DE AR DO CORPO DA BORBOLETA	2001/2003	MOTOR 1.0/1.3 FIRE 16V	C-9007	
PALIO WEEKEND		MANGUEIRA DE AR DO CORPO DA BORBOLETA	2003/2005	MOTOR 1.3 FIRE 8V	C-9011	
PALIO WEEKEND		MANGUEIRA DO RESPIRO DO MOTOR	1996/2000		C-9022	
PALIO WEEKEND		JOGO ANÉIS VEDAÇÃO COLETOR DE ADMISSÃO	2003/2005	MOTOR 1.3 FIRE/FIRE FLEX 8V	C-9504	
PALIO WEEKEND		JOGO ANÉIS VEDAÇÃO COLETOR DE ADMISSÃO	2006/...	MOTOR 1.4 FIRE FLEX 8V	C-9505	

Tabela de Conversão	Polegadas	9/16"	5/8"	11/16"	7/10"	3/4"	13/16"	7/8"	15/16"	1"	1 1/16"	1 1/8"	1 1/4"	1 3/8"	1 1/2"	1 5/8"	1 3/4"	1 27/32"	2"
	Milímetros	14,28mm	15,87mm	17,46mm	17,78mm	19,05mm	20,63mm	22,22mm	23,81mm	25,40mm	26,98mm	28,57mm	31,75mm	34,92mm	38,10mm	41,27mm	44,45mm	46,83mm	50,80mm

VEÍCULO		DESCRIÇÃO	ANOS	OBSERVAÇÃO	REF.	IMAGEM
<b>FIAT</b>						
PALIO WEEKEND		JOGO ANÉIS VEDAÇÃO COLETOR DE ADMISSÃO	2007/...	MOTOR 1.8 FLEX 8V	C-9501	
PANORAMA		SERVO FREIO 200mm	1983/1987	SIST. VARGA	C-5630	
PANORAMA		VÁLVULA DE RETENÇÃO DE VÁCUO	1980/1987	SIST. BENDIX	C-1755	
PANORAMA		VÁLVULA DE RETENÇÃO DE VÁCUO BRANCA	1983/1987	P/ SERVO VARGA FD180	C-1750	
PANORAMA		VÁLVULA DE RETENÇÃO DE VÁCUO	1983/1987	SIST. VARGA	C-1753	
PANORAMA		CILINDRO MESTRE DUPL0 19,05mm	1980/1987	SIST. ATE	C-2006	
PANORAMA		CILINDRO MESTRE DUPL0 20,63mm	1983/1987	SIST. VARGA	C-2087	
PANORAMA		REPARO DO CILINDRO MESTRE DUPL0 19,05mm	1980/1987	SIST. ATE	C-1098	
PANORAMA		REPARO DO CILINDRO MESTRE DUPL0 20,63mm	1983/1987	SIST. VARGA	C-1028	
PANORAMA		RESERVATÓRIO C/ TAMP A E AVISO DE NÍVEL	1983/1987	SIST. VARGA	C-0102	
PANORAMA		VEDANTE DO CILINDRO MESTRE	1980/1987	SIST. ATE	VE-0204	
PANORAMA		VEDANTE DO CILINDRO MESTRE	1983/1987	SIST. VARGA	VE-0201	
PANORAMA	<	REPARO DE VEDAÇÃO DA PINÇA 48,00mm	1980/1987	SIST. BENDIX	C-1421	
PANORAMA	<	REPARO DE VEDAÇÃO DA PINÇA 48,00mm	1981/1987	SIST. ATE (2 RODAS)	C-1434	
PANORAMA	>	CILINDRO DE RODA 19,05mm	1980/1987		C-3355	
PANORAMA	>	REPARO DO CILINDRO DE RODA 19,05mm	1980/1987	P/ CILINDRO BENDIX	C-1424	
PANORAMA	>	REPARO DO CILINDRO DE RODA 19,05mm	1980/1987		C-1427	
PANORAMA	>	COPO DO CILINDRO DE RODA 19,05mm	1980/1987	P/ CILINDRO BENDIX	CO-1312	
PANORAMA	>	GAXETA DO CILINDRO DE RODA 19,05mm	1980/1987		GA-0307	
PANORAMA	>	TAPA-PÓ DO CILINDRO DE RODA	1980/1987		TA-0303	
PANORAMA	>	TAPA-PÓ DO CILINDRO DE RODA	1980/1987	P/ CILINDRO BENDIX	TA-0310	
PRÊMIO		SERVO FREIO 200mm	1992/1996	SIST. ATE E BOSCH	C-5613	
PRÊMIO		VÁLVULA DE RETENÇÃO DE VÁCUO	1985/1996		C-1755	
PRÊMIO		CILINDRO MESTRE DUPL0 19,05mm	1985/1991		C-2030	
PRÊMIO		CILINDRO MESTRE DUPL0 20,63mm	1991/1996	SIST. ATE	C-2033	

BUSCA POR VEÍCULOS

Tabela de Conversão	Polegadas	9/16"	5/8"	11/16"	7/10"	3/4"	13/16"	7/8"	15/16"	1"	1 1/16"	1 1/8"	1 1/4"	1 3/8"	1 1/2"	1 5/8"	1 3/4"	1 27/32"	2"
	Milímetros	14,28mm	15,87mm	17,46mm	17,78mm	19,05mm	20,63mm	22,22mm	23,81mm	25,40mm	26,98mm	28,57mm	31,75mm	34,92mm	38,10mm	41,27mm	44,45mm	46,83mm	50,80mm

VEÍCULO		DESCRIÇÃO	ANOS	OBSERVAÇÃO	REF.	IMAGEM
<b>FIAT</b>						
PRÊMIO		CILINDRO MESTRE DUPL0 20,63mm	1991/1996	SIST. BOSCH	C-2035	
PRÊMIO		REPARO DO CILINDRO MESTRE DUPL0 19,05mm	1985/1991		C-1098	
PRÊMIO		REPARO DO CILINDRO MESTRE DUPL0 20,63mm	1991/1994	P/ CILINDRO BENDIX 2260511S	C-1120	
PRÊMIO		REPARO DO CILINDRO MESTRE DUPL0 20,63mm	1991/1996	SIST. ATE	C-1110	
PRÊMIO		REPARO DO CILINDRO MESTRE DUPL0 20,63mm	1991/1996	SIST. ATE - REPOSIÇÃO	C-1132	
PRÊMIO		REPARO DO CILINDRO MESTRE DUPL0 20,63mm	1991/1996	SIST. BOSCH	C-1142	
PRÊMIO		VEDANTE DO CILINDRO MESTRE	1985/1996		VE-0204	
PRÊMIO	<-	REPARO DE VEDAÇÃO DA PINÇA 48,00mm	1985/1996	SIST. ATE	C-1443	
PRÊMIO	<-	REPARO DE VEDAÇÃO DA PINÇA 48,00mm	1985/1996	SIST. VARGA	C-1532	
PRÊMIO	<-	TAPA PÓ DO PINO DE GUIA	1985/1996	SIST. VARGA	TA-0322	
PRÊMIO	->	CILINDRO DE RODA 19,05mm	1985/1996	EXCETO DUNA	C-3353	
PRÊMIO	->	REPARO DO CILINDRO DE RODA 19,05mm	1985/1996	EXCETO DUNA	C-1427	
PRÊMIO	->	GAXETA DO CILINDRO DE RODA 19,05mm	1985/1996	EXCETO DUNA	GA-0307	
PRÊMIO	->	TAPA-PÓ DO CILINDRO DE RODA	1985/1996		TA-0303	
PRÊMIO		MANGUEIRA DO FILTRO DE AR	1991/1994		C-9024	
PUNTO		CIL. ATUADOR CONCÊNTRICO DE EMBREAGEM	2005/...	MOTOR 1.8 8V / EtorQ 1.8 16V	C-2712	
PUNTO		CILINDRO AUXILIAR DE EMBREAGEM 22,22mm	2008/...	MOTOR 1.4	C-2648	
PUNTO	<-	REPARO DE VEDAÇÃO DA PINÇA 54,00mm	2008/...		C-1419	
PUNTO	->	CILINDRO DE RODA 20,63mm	2008/...		C-3478	
PUNTO	->	REPARO DO CILINDRO DE RODA 20,63mm	2008/...		C-1578	
PUNTO	->	GAXETA DO CILINDRO DE RODA 20,63mm	2008/...		GA-0206	
PUNTO	->	TAPA-PÓ DO CILINDRO DE RODA	2008/...		TA-0312	
SIENA		CILINDRO MESTRE DE EMBREAGEM 15,87mm	2001/...	MOTOR 1.0/1.3/1.4/1.6	C-2647	
SIENA		CILINDRO MESTRE DE EMBREAGEM 15,87mm	2006/...	MOTOR 1.8 SIST. LUK	C-2647	

Tabela de Conversão	Polegadas	9/16"	5/8"	11/16"	7/10"	3/4"	13/16"	7/8"	15/16"	1"	1 1/16"	1 1/8"	1 1/4"	1 3/8"	1 1/2"	1 5/8"	1 3/4"	1 27/32"	2"
	Milímetros	14,28mm	15,87mm	17,46mm	17,78mm	19,05mm	20,63mm	22,22mm	23,81mm	25,40mm	26,98mm	28,57mm	31,75mm	34,92mm	38,10mm	41,27mm	44,45mm	46,83mm	50,80mm

VEÍCULO		DESCRIÇÃO	ANOS	OBSERVAÇÃO	REF.	IMAGEM
<b>FIAT</b>						
SIENA		CILINDRO AUXILIAR DE EMBREAGEM 22,22mm	2001/...	MOTOR 1.0/1.3/1.4/1.6	C-2648	
SIENA		CIL. ATUADOR CONCÊNTRICO DE EMBREAGEM	2005/...	MOTOR 1.8 8V / EtorQ 1.8 16V	C-2712	
SIENA		SERVO FREIO 230mm	1998/1999	SIST. ATE E BOSCH S/ABS	C-5636	
SIENA		SERVO FREIO 230mm	1998/1999	C/ABS	C-5653	
SIENA		SERVO FREIO 230mm	2000/...	SIST. ATE E BOSCH S/ABS	C-5656	
SIENA		SERVO FREIO 230mm	2000/...	C/ABS	C-5657	
SIENA		CILINDRO MESTRE DUPLA 22,22mm	1998/...	SIST. BOSCH S/ABS	C-2042	
SIENA		CILINDRO MESTRE DUPLA 22,22mm	1998/...	SIST. ATE S/ABS	C-2075	
SIENA		CILINDRO MESTRE DUPLA 20,63mm	1998/1998	S/ABS	C-2046	
SIENA		REPARO DO CILINDRO MESTRE DUPLA 22,22mm	1998/...	SIST. BOSCH S/ABS	C-1119	
SIENA		REPARO DO CILINDRO MESTRE DUPLA 22,22mm	1998/...	SIST. ATE S/ABS	C-1152	
SIENA		REPARO DO CILINDRO MESTRE DUPLA 20,63mm	1998/1998	S/ABS	C-1132	
SIENA		VEDANTE DO CILINDRO MESTRE	1998/...		VE-0204	
SIENA	<	REPARO DE VEDAÇÃO DA PINÇA 54,00mm	1998/...		C-1419	
SIENA	<	REPARO DE VEDAÇÃO DA PINÇA 48,00mm	1998/1998		C-1443	
SIENA	>	CILINDRO DE RODA 19,05mm	1998/1998		C-3437	

Tabela de Conversão	Polegadas	9/16"	5/8"	11/16"	7/10"	3/4"	13/16"	7/8"	15/16"	1"	1 1/16"	1 1/8"	1 1/4"	1 3/8"	1 1/2"	1 5/8"	1 3/4"	1 27/32"	2"
	Milímetros	14,28mm	15,87mm	17,46mm	17,78mm	19,05mm	20,63mm	22,22mm	23,81mm	25,40mm	26,98mm	28,57mm	31,75mm	34,92mm	38,10mm	41,27mm	44,45mm	46,83mm	50,80mm











VEÍCULO		DESCRIÇÃO	ANOS	OBSERVAÇÃO	REF.	IMAGEM
<b>FIAT</b>						
SIENA	->	CILINDRO DE RODA 19,05mm	1999/2000	S/ABS	C-3472	
SIENA	->	CILINDRO DE RODA 20,63mm	1999/2000	C/ABS	C-3496	
SIENA	->	CILINDRO DE RODA 19,05mm	2001/...	MOTOR 1.0/1.3 S/ABS	C-3472	
SIENA	->	CILINDRO DE RODA 20,63mm	2001/...	MOTOR 1.6/1.8	C-3496	
SIENA	->	CILINDRO DE RODA 20,63mm	2001/...	MOTOR 1.0/1.3 C/ABS	C-3496	
SIENA	->	REPARO DO CILINDRO DE RODA 19,05mm	1998/1998		C-1556	
SIENA	->	REPARO DO CILINDRO DE RODA 20,63mm	1999/2000	C/ABS	C-1555	
SIENA	->	REPARO DO CILINDRO DE RODA 19,05mm	1999/2000	S/ABS	C-1556	
SIENA	->	REPARO DO CILINDRO DE RODA 20,63mm	2001/...	MOTOR 1.6/1.8	C-1555	
SIENA	->	REPARO DO CILINDRO DE RODA 20,63mm	2001/...	MOTOR 1.0/1.3 C/ABS	C-1555	
SIENA	->	REPARO DO CILINDRO DE RODA 19,05mm	2001/...	MOTOR 1.0/1.3 S/ABS	C-1556	
SIENA	->	GAXETA DO CILINDRO DE RODA 19,05mm	1998/1998		GA-0320	
SIENA	->	GAXETA DO CILINDRO DE RODA 20,63mm	1999/2000	C/ABS	GA-0217	
SIENA	->	GAXETA DO CILINDRO DE RODA 19,05mm	1999/2000	S/ABS	GA-0320	
SIENA	->	GAXETA DO CILINDRO DE RODA 20,63mm	2001/...	MOTOR 1.6/1.8	GA-0217	
SIENA	->	GAXETA DO CILINDRO DE RODA 20,63mm	2001/...	MOTOR 1.0/1.3 C/ABS	GA-0217	
SIENA	->	GAXETA DO CILINDRO DE RODA 19,05mm	2001/...	MOTOR 1.0/1.3 S/ABS	GA-0320	
SIENA	->	TAPA-PÓ DO CILINDRO DE RODA	1998/...		TA-0303	
SIENA		MANGUEIRA DO FILTRO DE AR	1998/1999	MOTOR 1.6 16V	C-9006	
SIENA		MANGUEIRA DO FILTRO DE AR	1998/2000	MOTOR 1.6 8V	C-9005	
SIENA		MANGUEIRA DO FILTRO DE AR	1998/2004	MOTOR 1.5 (SAIDA MAIOR)	C-9014	

Tabela de Conversão	Polegadas	9/16"	5/8"	11/16"	7/10"	3/4"	13/16"	7/8"	15/16"	1"	1 1/16"	1 1/8"	1 1/4"	1 3/8"	1 1/2"	1 5/8"	1 3/4"	1 27/32"	2"
	Milímetros	14,28mm	15,87mm	17,46mm	17,78mm	19,05mm	20,63mm	22,22mm	23,81mm	25,40mm	26,98mm	28,57mm	31,75mm	34,92mm	38,10mm	41,27mm	44,45mm	46,83mm	50,80mm

VEÍCULO		DESCRIÇÃO	ANOS	OBSERVAÇÃO	REF.	IMAGEM
<b>FIAT</b>						
SIENA		MANGUEIRA DO FILTRO DE AR	1998/2004	MOTOR 1.5 (SAIDA MENOR)	C-9015	
SIENA		MANGUEIRA DO FILTRO DE AR	2001/2003	MOTOR 1.0/1.3 FIRE 16V	C-9012	
SIENA		MANGUEIRA DO FILTRO DE AR	2001/2003	MOTOR 1.6 16V	C-9028	
SIENA		MANGUEIRA DO FILTRO DE AR	2002/2003	MOTOR 1.0 FIRE 8V	C-9001	
SIENA		MANGUEIRA DO FILTRO DE AR	2003/2005	MOTOR 1.3 FIRE 8V	C-9001	
SIENA		MANGUEIRA DO FILTRO DE AR	2004/2006	MOTOR 1.0 FIRE 8V	C-9003	
SIENA		MANGUEIRA DO FILTRO DE AR	2006/...	MOTOR 1.0 FIRE FLEX 8V	C-9001	
SIENA		MANGUEIRA DO FILTRO DE AR	2006/...	MOTOR 1.4 FIRE FLEX 8V	C-9002	
SIENA		MANGUEIRA DE AR DO CORPO DA BORBOLETA	2001/2003	MOTOR 1.0/1.3 FIRE 16V	C-9007	
SIENA		MANGUEIRA DE AR DO CORPO DA BORBOLETA	2003/...	MOTOR 1.0/1.3 FIRE/FIRE FLEX 8V	C-9011	
SIENA		MANGUEIRA DO RESPIRO DO MOTOR	1996/2000		C-9022	

Tabela de Conversão	Polegadas	9/16"	5/8"	11/16"	7/10"	3/4"	13/16"	7/8"	15/16"	1"	1 1/16"	1 1/8"	1 1/4"	1 3/8"	1 1/2"	1 5/8"	1 3/4"	1 27/32"	2"
	Milímetros	14,28mm	15,87mm	17,46mm	17,78mm	19,05mm	20,63mm	22,22mm	23,81mm	25,40mm	26,98mm	28,57mm	31,75mm	34,92mm	38,10mm	41,27mm	44,45mm	46,83mm	50,80mm









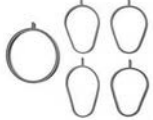

VEÍCULO		DESCRIÇÃO	ANOS	OBSERVAÇÃO	REF.	IMAGEM
<b>FIAT</b>						
SIENA		JOGO ANÉIS VEDAÇÃO COLETOR DE ADMISSÃO	2002/2004	MOTOR 1.0/1.3 FIRE 8V	C-9504	
SIENA		JOGO ANÉIS VEDAÇÃO COLETOR DE ADMISSÃO	2004/2006	MOTOR 1.0 FIRE 8V	C-9507	
SIENA		JOGO ANÉIS VEDAÇÃO COLETOR DE ADMISSÃO	2005/2005	MOTOR 1.3 FIRE FLEX 8V	C-9504	
SIENA		JOGO ANÉIS VEDAÇÃO COLETOR DE ADMISSÃO	2006/...	MOTOR 1.0 FIRE FLEX 8V	C-9504	
SIENA		JOGO ANÉIS VEDAÇÃO COLETOR DE ADMISSÃO	2006/...	MOTOR 1.4 FIRE FLEX 8V	C-9505	
SIENA		JOGO ANÉIS VEDAÇÃO COLETOR DE ADMISSÃO	2007/...	MOTOR 1.8 FLEX 8V	C-9501	
STILO		CIL. ATUADOR CONCÊNTRICO DE EMBREAGEM	2005/...	MOTOR 1.8 8V / EtorQ 1.8 16V	C-2712	
STILO	->	CILINDRO DE RODA 20,63mm	2003/2011		C-3411	
STILO	->	REPARO DO CILINDRO DE RODA 20,63mm	2003/2011		C-1534	
STILO	->	COPO DO CILINDRO DE RODA 20,63mm	2003/2011		CO-1317	
STILO	->	TAPA-PÓ DO CILINDRO DE RODA	2003/2011		TA-0321	
STILO		JOGO ANÉIS VEDAÇÃO COLETOR DE ADMISSÃO	2006/2011	MOTOR 1.8 FLEX 8V	C-9501	
STRADA		CILINDRO MESTRE DE EMBREAGEM 15,87mm	2001/...	MOTOR 1.3/1.4/1.6	C-2647	

Tabela de Conversão	Polegadas	9/16"	5/8"	11/16"	7/10"	3/4"	13/16"	7/8"	15/16"	1"	1 1/16"	1 1/8"	1 1/4"	1 3/8"	1 1/2"	1 5/8"	1 3/4"	1 27/32"	2"
	Milímetros	14,28mm	15,87mm	17,46mm	17,78mm	19,05mm	20,63mm	22,22mm	23,81mm	25,40mm	26,98mm	28,57mm	31,75mm	34,92mm	38,10mm	41,27mm	44,45mm	46,83mm	50,80mm

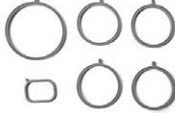









VEÍCULO		DESCRIÇÃO	ANOS	OBSERVAÇÃO	REF.	IMAGEM
<b>FIAT</b>						
STRADA		CILINDRO MESTRE DE EMBREAGEM 15,87mm	2005/...	MOTOR 1.8 SIST. LUK	C-2647	
STRADA		CILINDRO AUXILIAR DE EMBREAGEM 22,22mm	2001/...	MOTOR 1.3/1.4/1.6	C-2648	
STRADA		CIL. ATUADOR CONCÊNTRICO DE EMBREAGEM	2005/...	MOTOR 1.8 8V / EtorQ 1.8 16V	C-2712	
STRADA		SERVO FREIO 230mm	1999/1999	SIST. ATE E BOSCH S/ABS	C-5636	
STRADA		SERVO FREIO 230mm	1999/1999	C/ABS	C-5653	
STRADA		SERVO FREIO 230mm	2000/...	SIST. ATE E BOSCH S/ABS	C-5656	
STRADA		SERVO FREIO 230mm	2000/...	C/ABS	C-5657	
STRADA		CILINDRO MESTRE DUPLO 22,22mm	1999/...	SIST. BOSCH S/ABS	C-2042	
STRADA		CILINDRO MESTRE DUPLO 22,22mm	1999/...	SIST. ATE S/ABS	C-2075	
STRADA		REPARO DO CILINDRO MESTRE DUPLO 22,22mm	1999/...	SIST. BOSCH S/ABS	C-1119	
STRADA		REPARO DO CILINDRO MESTRE DUPLO 22,22mm	1999/...	SIST. ATE S/ABS	C-1152	
STRADA		VEDANTE DO CILINDRO MESTRE	1999/...		VE-0204	
STRADA	<	REPARO DE VEDAÇÃO DA PINÇA 54,00mm	1999/...		C-1419	
STRADA	>	CILINDRO DE RODA 20,63mm	1999/2012		C-3411	
STRADA	>	REPARO DO CILINDRO DE RODA 20,63mm	1999/2012		C-1534	
STRADA	>	COPO DO CILINDRO DE RODA 20,63mm	1999/...		CO-1317	
STRADA	>	TAPA-PÓ DO CILINDRO DE RODA	1999/...		TA-0321	

Tabela de Conversão	Polegadas	9/16"	5/8"	11/16"	7/10"	3/4"	13/16"	7/8"	15/16"	1"	1 1/16"	1 1/8"	1 1/4"	1 3/8"	1 1/2"	1 5/8"	1 3/4"	1 27/32"	2"
	Milímetros	14,28mm	15,87mm	17,46mm	17,78mm	19,05mm	20,63mm	22,22mm	23,81mm	25,40mm	26,98mm	28,57mm	31,75mm	34,92mm	38,10mm	41,27mm	44,45mm	46,83mm	50,80mm

VEÍCULO		DESCRIÇÃO	ANOS	OBSERVAÇÃO	REF.	IMAGEM
<b>FIAT</b>						
STRADA		MANGUEIRA DO FILTRO DE AR	1999/2000	MOTOR 1.6 8V	C-9005	
STRADA		MANGUEIRA DO FILTRO DE AR	1999/2001	MOTOR 1.6 16V	C-9006	
STRADA		MANGUEIRA DO FILTRO DE AR	1999/2001	MOTOR 1.6 16V	C-9028	
STRADA		MANGUEIRA DO FILTRO DE AR	1999/2004	MOTOR 1.5 (SAIDA MAIOR)	C-9014	
STRADA		MANGUEIRA DO FILTRO DE AR	1999/2004	MOTOR 1.5 (SAIDA MENOR)	C-9015	
STRADA		MANGUEIRA DO FILTRO DE AR	2003/2005	MOTOR 1.3 FIRE 8V	C-9001	
STRADA		MANGUEIRA DO FILTRO DE AR	2006/...	MOTOR 1.4 FIRE FLEX 8V	C-9002	
STRADA		MANGUEIRA DE AR DO CORPO DA BORBOLETA	2003/2005	MOTOR 1.3 FIRE 8V	C-9011	
STRADA		MANGUEIRA DO RESPIRO DO MOTOR	1996/2000		C-9022	
STRADA		JOGO ANÉIS VEDAÇÃO COLETOR DE ADMISSÃO	2003/2005	MOTOR 1.3 FIRE 8V	C-9504	
STRADA		JOGO ANÉIS VEDAÇÃO COLETOR DE ADMISSÃO	2006/...	MOTOR 1.4 FIRE FLEX 8V	C-9505	

Tabela de Conversão	Polegadas	9/16"	5/8"	11/16"	7/10"	3/4"	13/16"	7/8"	15/16"	1"	1 1/16"	1 1/8"	1 1/4"	1 3/8"	1 1/2"	1 5/8"	1 3/4"	1 27/32"	2"
	Milímetros	14,28mm	15,87mm	17,46mm	17,78mm	19,05mm	20,63mm	22,22mm	23,81mm	25,40mm	26,98mm	28,57mm	31,75mm	34,92mm	38,10mm	41,27mm	44,45mm	46,83mm	50,80mm

VEÍCULO		DESCRIÇÃO	ANOS	OBSERVAÇÃO	REF.	IMAGEM
<b>FIAT</b>						
STRADA		JOGO ANÉIS VEDAÇÃO COLETOR DE ADMISSÃO	2007/...	MOTOR 1.8 FLEX 8V	C-9501	
TEMPRA		SERVO FREIO 200mm	1992/1999	MOTOR 2.0 8V/16V S/ABS	C-5625	
TEMPRA		SERVO FREIO 200mm	1993/1999	MOTOR 2.0 16V C/ABS	C-5648	
TEMPRA		CILINDRO MESTRE DUPL0 22,22mm	1992/1999	MOTOR 2.0 8V/16V S/ABS	C-2042	
TEMPRA		CILINDRO MESTRE DUPL0 22,22mm	1993/1999	MOTOR 2.0 16V C/ABS	C-2133	
TEMPRA		CILINDRO MESTRE DUPL0 22,22mm	1995/1998	MOTOR 2.0 TURBO C/ CIL. BENDIX C/ ABS	C-2133	
TEMPRA		CILINDRO MESTRE DUPL0 22,22mm	1995/1998	MOTOR 2.0 TURBO C/ CIL. BENDIX S/ ABS	C-2140	
TEMPRA		REPARO DO CILINDRO MESTRE DUPL0 22,22mm	1992/1994	P/ CILINDRO BENDIX 2261700S	C-1118	
TEMPRA		REPARO DO CILINDRO MESTRE DUPL0 22,22mm	1992/1999	MOTOR 2.0 8V/16V S/ABS	C-1119	
TEMPRA		REPARO DO CILINDRO MESTRE DUPL0 22,22mm	1993/1999	MOTOR 2.0 16V C/ABS	C-1131	
TEMPRA		REPARO DO CILINDRO MESTRE DUPL0 22,22mm	1995/1998	MOTOR 2.0 TURBO C/ CIL. BENDIX	C-1131	
TEMPRA		VEDANTE DO CILINDRO MESTRE	1992/1999		VE-0204	
TEMPRA	<	REPARO DE VEDAÇÃO DA PINÇA 54,00mm	1992/1999		C-1419	
TEMPRA	>	CILINDRO DE RODA 20,63mm	1992/1999		C-3411	
TEMPRA	>	REPARO DO CILINDRO DE RODA 20,63mm	1992/1999		C-1534	
TEMPRA	>	COPO DO CILINDRO DE RODA 20,63mm	1992/1999		CO-1317	
TEMPRA	>	TAPA-PÓ DO CILINDRO DE RODA	1992/1999		TA-0321	
TEMPRA	>	REPARO DE VEDAÇÃO DA PINÇA 38,00mm	1993/1999		C-1549	
TEMPRA	>	TAPA PÓ DO PINO DE GUIA	1993/1999		TA-0322	
TEMPRA SW		SERVO FREIO 200mm	1994/1997		C-5626	
TEMPRA SW		VÁLVULA DE RETENÇÃO DE VÁCUO	1994/1997		C-1753	

BUSCA POR VEÍCULOS

Tabela de Conversão	Polegadas	9/16"	5/8"	11/16"	7/10"	3/4"	13/16"	7/8"	15/16"	1"	1 1/16"	1 1/8"	1 1/4"	1 3/8"	1 1/2"	1 5/8"	1 3/4"	1 27/32"	2"
	Milímetros	14,28mm	15,87mm	17,46mm	17,78mm	19,05mm	20,63mm	22,22mm	23,81mm	25,40mm	26,98mm	28,57mm	31,75mm	34,92mm	38,10mm	41,27mm	44,45mm	46,83mm	50,80mm

VEÍCULO		DESCRIÇÃO	ANOS	OBSERVAÇÃO	REF.	IMAGEM
<b>FIAT</b>						
TEMPRA SW		CILINDRO MESTRE DUPL0 22,22mm	1994/1997	S/ABS	C-2053	
TEMPRA SW		REPARO DO CILINDRO MESTRE DUPL0 22,22mm	1994/1997	P/ CIL. BENDIX	C-1130	
TEMPRA SW		VEDANTE DO CILINDRO MESTRE	1994/1997		VE-0204	
TEMPRA SW	<-	REPARO DE VEDAÇÃO DA PINÇA 54,00mm	1994/1997	SIST. ATE	C-1419	
TEMPRA SW	<-	REPARO DE VEDAÇÃO DA PINÇA 54,00mm	1994/1997	SIST. GIRLING/BENDIX	C-1558	
TEMPRA SW	<-	TAPA PÓ DO PINO DE GUIA	1994/1997	SIST. GIRLING/BENDIX	TA-0322	
TEMPRA SW	->	REPARO DE VEDAÇÃO DA PINÇA 34,00mm	1994/1997		C-1537	
TEMPRA SW	->	TAPA PÓ DO PINO DE GUIA	1994/1997		TA-0322	
TIPO		SERVO FREIO 200mm	1993/1997		C-5626	
TIPO		VÁLVULA DE RETENÇÃO DE VÁCUO	1993/1997		C-1753	
TIPO		CILINDRO MESTRE DUPL0 22,22mm	1993/1997	S/ABS	C-2053	
TIPO		REPARO DO CILINDRO MESTRE DUPL0 22,22mm	1993/1997	P/ CIL. BENDIX	C-1130	
TIPO		VEDANTE DO CILINDRO MESTRE	1993/1997		VE-0204	
TIPO	<-	REPARO DE VEDAÇÃO DA PINÇA 54,00mm	1993/1995	MOTOR 2.0 8V/16V	C-1419	
TIPO	<-	REPARO DE VEDAÇÃO DA PINÇA 54,00mm	1993/1995	MOTOR 1.6 ie	C-1558	
TIPO	<-	REPARO DE VEDAÇÃO DA PINÇA 54,00mm	1996/1997	MOTOR 1.6 mpi	C-1419	
TIPO	<-	TAPA PÓ DO PINO DE GUIA	1993/1995	MOTOR 1.6 ie	TA-0322	
TIPO	->	CILINDRO DE RODA 22,00mm	1993/1997		C-3413	
TIPO	->	REPARO DO CILINDRO DE RODA 22,00mm	1993/1997		C-1540	
TIPO	->	GAXETA DO CILINDRO DE RODA 22,00mm	1993/1997		GA-0319	
TIPO	->	TAPA-PÓ DO CILINDRO DE RODA	1993/1997		TA-0367	
TIPO	->	REPARO DE VEDAÇÃO DA PINÇA 34,00mm	1993/1995		C-1537	
TIPO	->	TAPA PÓ DO PINO DE GUIA	1993/1995		TA-0322	
UNO		SERVO FREIO 200mm	1992/1999	SIST. ATE E BOSCH	C-5613	
UNO		SERVO FREIO 200mm	2000/2010		C-5649	
UNO		SERVO FREIO 200mm	2011/...	MILLE/FURGÃO	C-5649	
UNO		VÁLVULA DE RETENÇÃO DE VÁCUO	1984/...		C-1755	

Tabela de Conversão	Polegadas	9/16"	5/8"	11/16"	7/10"	3/4"	13/16"	7/8"	15/16"	1"	1 1/16"	1 1/8"	1 1/4"	1 3/8"	1 1/2"	1 5/8"	1 3/4"	1 27/32"	2"
	Milímetros	14,28mm	15,87mm	17,46mm	17,78mm	19,05mm	20,63mm	22,22mm	23,81mm	25,40mm	26,98mm	28,57mm	31,75mm	34,92mm	38,10mm	41,27mm	44,45mm	46,83mm	50,80mm

VEÍCULO		DESCRIÇÃO	ANOS	OBSERVAÇÃO	REF.	IMAGEM
<b>FIAT</b>						
UNO		CILINDRO MESTRE DUPLO 19,05mm	1984/1991		C-2030	
UNO		CILINDRO MESTRE DUPLO 20,63mm	1987/1991	MOD. 1.5R/1.6R	C-2033	
UNO		CILINDRO MESTRE DUPLO 20,63mm	1991/2010	SIST. ATE	C-2033	
UNO		CILINDRO MESTRE DUPLO 20,63mm	1991/2010	SIST. BOSCH	C-2035	
UNO		CILINDRO MESTRE DUPLO 20,63mm	2011/...	MILLE/FURGÃO	C-2033	
UNO		CILINDRO MESTRE DUPLO 22,22mm	2011/...	MOTOR 1.4 S/ABS	C-2181	
UNO		REPARO DO CILINDRO MESTRE DUPLO 19,05mm	1984/1991		C-1098	
UNO		REPARO DO CILINDRO MESTRE DUPLO 20,63mm	1987/1991	MOD. 1.5R/1.6R	C-1110	
UNO		REPARO DO CILINDRO MESTRE DUPLO 20,63mm	1987/1991	MOD. 1.5R/1.6R - REPOSIÇÃO	C-1132	
UNO		REPARO DO CILINDRO MESTRE DUPLO 20,63mm	1991/1994	P/ CILINDRO BENDIX 2260511S	C-1120	
UNO		REPARO DO CILINDRO MESTRE DUPLO 20,63mm	1991/2001	SIST. ATE	C-1110	
UNO		REPARO DO CILINDRO MESTRE DUPLO 20,63mm	1991/2001	SIST. ATE - REPOSIÇÃO	C-1132	
UNO		REPARO DO CILINDRO MESTRE DUPLO 20,63mm	1991/2010	SIST. BOSCH	C-1142	
UNO		REPARO DO CILINDRO MESTRE DUPLO 20,63mm	2001/2010	SIST. ATE	C-1132	
UNO		REPARO DO CILINDRO MESTRE DUPLO 20,63mm	2011/...	MILLE/FURGÃO	C-1132	
UNO		VEDANTE DO CILINDRO MESTRE	1984/...		VE-0204	
UNO	<	REPARO DE VEDAÇÃO DA PINÇA 48,00mm	1984/...	SIST. ATE C/ DISCO 240mm	C-1443	
UNO	<	REPARO DE VEDAÇÃO DA PINÇA 48,00mm	1984/1998	SIST. VARGA, BENDIX, WEBER E GIRLING	C-1532	
UNO	<	REPARO DE VEDAÇÃO DA PINÇA 48,00mm	1986/1988	SIST. ATE C/ DISCO 227mm (2 RODAS)	C-1434	
UNO	<	TAPA PÓ DO PINO DE GUIA	1984/...	SIST. VARGA, BENDIX, WEBER E GIRLING	TA-0322	
UNO	>	CILINDRO DE RODA 19,05mm	1984/2008		C-3353	
UNO	>	CILINDRO DE RODA 17,46mm	1987/1996	MOD. 1.5R/1.6R	C-3404	
UNO	>	CILINDRO DE RODA 19,05mm	2008/2010		C-3472	

Tabela de Conversão	Polegadas	9/16"	5/8"	11/16"	7/10"	3/4"	13/16"	7/8"	15/16"	1"	1 1/16"	1 1/8"	1 1/4"	1 3/8"	1 1/2"	1 5/8"	1 3/4"	1 27/32"	2"
	Milímetros	14,28mm	15,87mm	17,46mm	17,78mm	19,05mm	20,63mm	22,22mm	23,81mm	25,40mm	26,98mm	28,57mm	31,75mm	34,92mm	38,10mm	41,27mm	44,45mm	46,83mm	50,80mm













VEÍCULO		DESCRIÇÃO	ANOS	OBSERVAÇÃO	REF.	IMAGEM
<b>FIAT</b>						
UNO	->	CILINDRO DE RODA 19,05mm	2011/...	MILLE/FURGÃO	C-3472	
UNO	->	CILINDRO DE RODA 20,63mm	2011/...	S/ABS COM 1 FURO DE FIXAÇÃO	C-3496	
UNO	->	CILINDRO DE RODA 19,05mm	2012/...	CABRIO 1.4 8V	C-3427	
UNO	->	CILINDRO DE RODA 19,05mm	2012/...	ECONOMY 1.4 8V	C-3427	
UNO	->	CILINDRO DE RODA 19,05mm	2012/...	FIRE ECONOMY 1.0 8V	C-3427	
UNO	->	CILINDRO DE RODA 19,05mm	2012/...	FIRE SMART 1.0 8V	C-3427	
UNO	->	CILINDRO DE RODA 19,05mm	2012/...	FURGÃO 1.3 8V	C-3427	
UNO	->	CILINDRO DE RODA 19,05mm	2012/...	SPORTING 1.4 8V	C-3427	
UNO	->	CILINDRO DE RODA 20,63mm	2012/...	ATTRACTIVE 1.4 8V	C-3428	
UNO	->	REPARO DO CILINDRO DE RODA 19,05mm	1984/2008		C-1427	
UNO	->	REPARO DO CILINDRO DE RODA 19,05mm	2008/2010		C-1556	
UNO	->	REPARO DO CILINDRO DE RODA 20,63mm	2011/...	S/ABS	C-1555	
UNO	->	REPARO DO CILINDRO DE RODA 19,05mm	2011/...	MILLE/FURGÃO	C-1556	
UNO	->	GAXETA DO CILINDRO DE RODA 19,05mm	1984/2008		GA-0307	
UNO	->	GAXETA DO CILINDRO DE RODA 17,46mm	1987/1996	MOD. 1.5R/1.6R	GA-0309	
UNO	->	GAXETA DO CILINDRO DE RODA 19,05mm	2008/2010		GA-0320	
UNO	->	GAXETA DO CILINDRO DE RODA 20,63mm	2011/...	S/ABS	GA-0217	

Tabela de Conversão	Polegadas	9/16"	5/8"	11/16"	7/10"	3/4"	13/16"	7/8"	15/16"	1"	1 1/16"	1 1/8"	1 1/4"	1 3/8"	1 1/2"	1 5/8"	1 3/4"	1 27/32"	2"
	Milímetros	14,28mm	15,87mm	17,46mm	17,78mm	19,05mm	20,63mm	22,22mm	23,81mm	25,40mm	26,98mm	28,57mm	31,75mm	34,92mm	38,10mm	41,27mm	44,45mm	46,83mm	50,80mm

VEÍCULO		DESCRIÇÃO	ANOS	OBSERVAÇÃO	REF.	IMAGEM
<b>FIAT</b>						
UNO	->	GAXETA DO CILINDRO DE RODA 19,05mm	2011/...	MILLE/FURGÃO	GA-0320	
UNO	->	TAPA-PÓ DO CILINDRO DE RODA	1984/...		TA-0303	
UNO		MANGUEIRA DO FILTRO DE AR	1991/1993	MILLE	C-9024	
UNO		MANGUEIRA DO FILTRO DE AR	1991/1996		C-9024	
UNO		MANGUEIRA DO FILTRO DE AR	1996/2000	MILLE SPI	C-9024	
UNO		MANGUEIRA DO FILTRO DE AR	1997/2004	FURGÃO / BOCAL MENOR PARA SENSOR	C-9025	
UNO		MANGUEIRA DO FILTRO DE AR	1997/2004	FURGÃO / BOCAL MAIOR PARA SENSOR	C-9026	
UNO		MANGUEIRA DO FILTRO DE AR	2000/2001	SMART	C-9024	
UNO		MANGUEIRA DO FILTRO DE AR	2001/2003	1.3 8V	C-9025	
UNO		MANGUEIRA DO FILTRO DE AR	2001/2003	BOCAL MAIOR PARA SENSOR	C-9026	
UNO		MANGUEIRA DO FILTRO DE AR	2002/2006	MOTOR 1.0 FIRE 8V	C-9004	
UNO		MANGUEIRA DO FILTRO DE AR	2004/...	MOTOR 1.3 MPI 8V	C-9004	
UNO		MANGUEIRA DO FILTRO DE AR	2006/2006	MOTOR 1.0 FIRE FLEX 8V	C-9001	
UNO		MANGUEIRA DE AR DO CORPO DA BORBOLETA	2002/...	MOTOR 1.0/1.3 FIRE/FIRE FLEX 8V	C-9011	

BUSCA POR VEÍCULOS

Tabela de Conversão	Polegadas	9/16"	5/8"	11/16"	7/10"	3/4"	13/16"	7/8"	15/16"	1"	1 1/16"	1 1/8"	1 1/4"	1 3/8"	1 1/2"	1 5/8"	1 3/4"	1 27/32"	2"
	Milímetros	14,28mm	15,87mm	17,46mm	17,78mm	19,05mm	20,63mm	22,22mm	23,81mm	25,40mm	26,98mm	28,57mm	31,75mm	34,92mm	38,10mm	41,27mm	44,45mm	46,83mm	50,80mm









VEÍCULO		DESCRIÇÃO	ANOS	OBSERVAÇÃO	REF.	IMAGEM
<b>FIAT</b>						
UNO		MANGUEIRA DO RESPIRO DO MOTOR	1985/2004		C-9023	
UNO		JOGO ANÉIS VEDAÇÃO COLETOR DE ADMISSÃO	2002/...	MOTOR 1.0/1.3 FIRE/FIRE FLEX 8V	C-9504	
UNO TURBO		SERVO FREIO 200mm	1994/1996		C-5629	
UNO TURBO		VÁLVULA DE RETENÇÃO DE VÁCUO	1994/1996		C-1755	
UNO TURBO		REPARO DO CILINDRO MESTRE DUPL0 22,22mm	1994/1994		C-1118	
UNO TURBO		REPARO DO CILINDRO MESTRE DUPL0 22,22mm	1994/1996		C-1119	
UNO TURBO		VEDANTE DO CILINDRO MESTRE	1994/1996		VE-0204	
UNO TURBO	<-	REPARO DE VEDAÇÃO DA PINÇA 54,00mm	1994/1996		C-1419	
UNO TURBO	->	CILINDRO DE RODA 20,63mm	1994/1996		C-3411	
UNO TURBO	->	REPARO DO CILINDRO DE RODA 20,63mm	1994/1996		C-1534	
UNO TURBO	->	COPO DO CILINDRO DE RODA 20,63mm	1994/1996		CO-1317	
UNO TURBO	->	TAPA-PÓ DO CILINDRO DE RODA	1994/1996		TA-0321	
UNO WAY		CILINDRO MESTRE DUPL0 22,22mm	2011/...	MOTOR 1.0	C-2181	
UNO WAY	->	CILINDRO DE RODA 20,63mm	2012/...	1.0 8V	C-3428	
UNO VIVACE		SERVO FREIO 200mm	2011/...	MOTOR 1.0 S/ABS	C-5674	
UNO VIVACE		CILINDRO MESTRE DUPL0 20,63mm	2011/...	MOTOR 1.0 S/ABS	C-2182	
UNO VIVACE	->	CILINDRO DE RODA 20,63mm	2012/...	1.0 8V	C-3428	
<b>FIAT ALLIS</b>						
134BR		REPARO DO CILINDRO MESTRE SIMPLES 31,75mm	.../1983		C-1040	
1500BR		REPARO DO CILINDRO MESTRE SIMPLES 31,75mm	.../1983		C-1040	
1911BR		REPARO DO CILINDRO MESTRE SIMPLES 31,75mm	.../1983		C-1040	
FR10M		REPARO DO CILINDRO MESTRE SIMPLES 31,75mm	1983/...		C-1059	
FR11M		REPARO DO CILINDRO MESTRE SIMPLES 31,75mm	1983/...		C-1059	
FR12M		REPARO DO CILINDRO MESTRE SIMPLES 31,75mm	1983/...		C-1059	
<b>FIAT - CAMINHÕES</b>						
70/80		REPARO DO HYDROVAC 9 1/2"	1982/1985		C-1213	
70/80	<-	REPARO DO CILINDRO DE RODA 34,92mm	1980/1985		C-1520	
70/80	<-	GAXETA DO CILINDRO DE RODA 34,92mm	1980/1985		GA-0318	
70/80	<-	TAPA-PÓ DO CILINDRO DE RODA	1978/1980		TA-0315	
70/80	<-	TAPA-PÓ DO CILINDRO DE RODA	1980/1985		TA-0325	





Tabela de Conversão	Polegadas	9/16"	5/8"	11/16"	7/10"	3/4"	13/16"	7/8"	15/16"	1"	1 1/16"	1 1/8"	1 1/4"	1 3/8"	1 1/2"	1 5/8"	1 3/4"	1 27/32"	2"
	Milímetros	14,28mm	15,87mm	17,46mm	17,78mm	19,05mm	20,63mm	22,22mm	23,81mm	25,40mm	26,98mm	28,57mm	31,75mm	34,92mm	38,10mm	41,27mm	44,45mm	46,83mm	50,80mm

VEÍCULO		DESCRIÇÃO	ANOS	OBSERVAÇÃO	REF.	IMAGEM
<b>FIAT - CAMINHÕES</b>						
70/80	->	TAPA-PÓ DO CILINDRO DE RODA	1978/1980		TA-0315	
100		REPARO DO CIL. MESTRE DE EMBREAGEM 28,57mm	1977/1985		C-1610	
120		REPARO DO CILINDRO MESTRE SIMPLES 31,75mm	1979/1980		C-1040	
120	<	CILINDRO DE RODA ESQUERDA SUPERIOR 41,27mm	1979/1985		C-3315	
120	<	CILINDRO DE RODA DIREITA SUPERIOR 41,27mm	1979/1985		C-3316	
120	<	REPARO DO CILINDRO DE RODA 41,27mm	1979/1985		C-1485	
120	<	GAXETA DO CILINDRO DE RODA 41,27mm	1979/1985		GA-0300	
120	<	TAPA-PÓ DO CILINDRO DE RODA	1979/1985		TA-0323	
120	->	CILINDRO DE RODA ESQUERDA SUPERIOR 41,27mm	1979/1985		C-3315	
120	->	CILINDRO DE RODA DIREITA SUPERIOR 41,27mm	1979/1985		C-3316	
120	->	REPARO DO CILINDRO DE RODA 41,27mm	1979/1985		C-1485	
120	->	GAXETA DO CILINDRO DE RODA 41,27mm	1979/1985		GA-0300	
120	->	TAPA-PÓ DO CILINDRO DE RODA	1979/1985		TA-0323	
140/150/180		REPARO DO CIL. MESTRE DE EMBREAGEM 28,57mm	1977/1985		C-1610	
190		REPARO DO CIL. MESTRE DE EMBREAGEM 28,57mm	1975/1985		C-1610	
210/211		REPARO DO CIL. MESTRE DE EMBREAGEM 28,57mm	1975/1978		C-1610	
<b>FORD</b>						
AERO/ITAMARATY		CILINDRO MESTRE SIMPLES 25,40mm	1961/1971		C-2036	
AERO/ITAMARATY		REPARO DO CILINDRO MESTRE SIMPLES 25,40mm	1961/1971		C-1013	
AERO/ITAMARATY	<	CILINDRO DE RODA ESQUERDA 28,57mm	1961/1961		C-3378	
AERO/ITAMARATY	<	CILINDRO DE RODA DIREITA 28,57mm	1961/1961		C-3379	
AERO/ITAMARATY	<	CILINDRO DE RODA ESQUERDA 28,57mm	1961/1971		C-3390	

Tabela de Conversão	Polegadas	9/16"	5/8"	11/16"	7/10"	3/4"	13/16"	7/8"	15/16"	1"	1 1/16"	1 1/8"	1 1/4"	1 3/8"	1 1/2"	1 5/8"	1 3/4"	1 27/32"	2"
	Milímetros	14,28mm	15,87mm	17,46mm	17,78mm	19,05mm	20,63mm	22,22mm	23,81mm	25,40mm	26,98mm	28,57mm	31,75mm	34,92mm	38,10mm	41,27mm	44,45mm	46,83mm	50,80mm

VEÍCULO		DESCRIÇÃO	ANOS	OBSERVAÇÃO	REF.	IMAGEM
<b>FORD</b>						
AERO/ITAMARATY	<-	CILINDRO DE RODA DIREITA 28,57mm	1961/1971		C-3391	
AERO/ITAMARATY	<-	REPARO DO CILINDRO DE RODA 28,57mm	1961/1961		C-1438	
AERO/ITAMARATY	<-	REPARO DO CILINDRO DE RODA 28,57mm	1961/1971		C-1422	
AERO/ITAMARATY	<-	COPO DO CILINDRO DE RODA 28,57mm	1961/1971		CO-1309	
AERO/ITAMARATY	<-	TAPA-PÓ DO CILINDRO DE RODA	1961/1961		TA-0316	
AERO/ITAMARATY	<-	TAPA-PÓ DO CILINDRO DE RODA	1961/1971		TA-0349	
AERO/ITAMARATY	->	CILINDRO DE RODA ESQUERDA 25,40mm	1961/1961		C-3380	
AERO/ITAMARATY	->	CILINDRO DE RODA DIREITA 25,40mm	1961/1961		C-3381	
AERO/ITAMARATY	->	CILINDRO DE RODA ESQUERDA 25,40mm	1961/1962		C-3392	
AERO/ITAMARATY	->	CILINDRO DE RODA DIREITA 25,40mm	1961/1962		C-3393	
AERO/ITAMARATY	->	CILINDRO DE RODA ESQUERDA 22,22mm	1963/1971		C-3460	
AERO/ITAMARATY	->	CILINDRO DE RODA DIREITA 22,22mm	1963/1971		C-3461	
AERO/ITAMARATY	->	REPARO DO CILINDRO DE RODA 25,40mm	1961/1961		C-1435	
AERO/ITAMARATY	->	REPARO DO CILINDRO DE RODA 25,40mm	1961/1962		C-1416	
AERO/ITAMARATY	->	REPARO DO CILINDRO DE RODA 22,22mm	1963/1971		C-1407	
AERO/ITAMARATY	->	COPO DO CILINDRO DE RODA 25,40mm	1961/1962		CO-1307	
AERO/ITAMARATY	->	COPO DO CILINDRO DE RODA 22,22mm	1963/1971		CO-1315	
AERO/ITAMARATY	->	TAPA-PÓ DO CILINDRO DE RODA	1961/1961		TA-0320	
AERO/ITAMARATY	->	TAPA-PÓ DO CILINDRO DE RODA	1961/1971		TA-0314	
BELINA		REPARO DO CILINDRO MESTRE SIMPLES 19,05mm	1969/1976		C-1062	
BELINA		REPARO DO CILINDRO MESTRE DUPLA 19,05mm	1977/1977		C-1099	
BELINA		RESERVATÓRIO C/ TAMPÃO E AVISO DE NÍVEL	1977/1977		C-0102	
BELINA		VEDANTE DO CILINDRO MESTRE	1977/1977		VE-0201	
BELINA	<-	REPARO DE VEDAÇÃO DA PINÇA 48,00mm	1969/1977		C-1479	
BELINA	->	CILINDRO DE RODA ESQUERDA 19,05mm	1969/1977		C-3358	
BELINA	->	CILINDRO DE RODA DIREITA 19,05mm	1969/1977		C-3359	
BELINA	->	REPARO DO CILINDRO DE RODA 19,05mm	1969/1977		C-1441	
BELINA	->	COPO DO CILINDRO DE RODA 19,05mm	1969/1977		CO-1312	
BELINA	->	TAPA-PÓ DO CILINDRO DE RODA	1969/1977		TA-0310	

Tabela de Conversão	Polegadas	9/16"	5/8"	11/16"	7/10"	3/4"	13/16"	7/8"	15/16"	1"	1 1/16"	1 1/8"	1 1/4"	1 3/8"	1 1/2"	1 5/8"	1 3/4"	1 27/32"	2"
	Milímetros	14,28mm	15,87mm	17,46mm	17,78mm	19,05mm	20,63mm	22,22mm	23,81mm	25,40mm	26,98mm	28,57mm	31,75mm	34,92mm	38,10mm	41,27mm	44,45mm	46,83mm	50,80mm

VEÍCULO		DESCRIÇÃO	ANOS	OBSERVAÇÃO	REF.	IMAGEM
<b>FORD</b>						
BELINA II		SERVO FREIO 200mm	1980/1991		C-5601	
BELINA II		VÁLVULA DE RETENÇÃO DE VÁCUO BRANCA	1978/1991	P/ SERVO VARGA FD30/FD150/SM180	C-1750	
BELINA II		VÁLVULA DE RETENÇÃO DE VÁCUO	1980/1991		C-1753	
BELINA II		CILINDRO MESTRE DUPL0 22,22mm	1978/1991	C/SERVO	C-2002	
BELINA II		REPARO DO CILINDRO MESTRE DUPL0 19,05mm	1978/1980	S/SERVO	C-1099	
BELINA II		REPARO DO CILINDRO MESTRE DUPL0 22,22mm	1978/1991		C-1019	
BELINA II		REPARO DO CILINDRO MESTRE DUPL0 20,63mm	1978/1991	P/ CILINDRO VARGA 13/16"	C-1047	
BELINA II		RESERVATÓRIO C/ TAMP A E AVISO DE NÍVEL	1978/1991		C-0102	
BELINA II		VEDANTE DO CILINDRO MESTRE	1978/1991		VE-0201	
BELINA II	<-	REPARO DE VEDAÇÃO DA PINÇA 48,00mm	1978/1989	SIST. BENDIX COIFA C/ ENCAIXE INTERNO	C-1421	
BELINA II	<-	REPARO DE VEDAÇÃO DA PINÇA 48,00mm	1978/1989	SIST. BENDIX COIFA C/ ENCAIXE EXTERNO	C-1479	
BELINA II	<-	REPARO DE VEDAÇÃO DA PINÇA 48,00mm	1981/1989	SIST. ATE (2 RODAS)	C-1434	
BELINA II	<-	REPARO DE VEDAÇÃO DA PINÇA 48,00mm	1983/1991	SIST. VARGA	C-1413	
BELINA II	<-	TAPA PÓ DO PINO DE GUIA	1983/1991	SIST. VARGA	TA-0322	
BELINA II	->	CILINDRO DE RODA ESQUERDA 19,05mm	1978/1991	SIST. BENDIX	C-3358	
BELINA II	->	CILINDRO DE RODA DIREITA 19,05mm	1978/1991	SIST. BENDIX	C-3359	
BELINA II	->	CILINDRO DE RODA ESQUERDA 19,05mm	1978/1991	SIST. VARGA	C-3397	
BELINA II	->	CILINDRO DE RODA DIREITA 19,05mm	1978/1991	SIST. VARGA	C-3398	
BELINA II	->	REPARO DO CILINDRO DE RODA 22,22mm	1978/1979	P/ CILINDRO VARGA 7/8"	C-1439	
BELINA II	->	REPARO DO CILINDRO DE RODA 22,22mm	1978/1979	P/ CILINDRO BENDIX 7/8"	C-1442	
BELINA II	->	REPARO DO CILINDRO DE RODA 20,63mm	1978/1981	P/ CILINDRO BENDIX 13/16"	C-1510	
BELINA II	->	REPARO DO CILINDRO DE RODA 19,05mm	1978/1991	SIST. BENDIX	C-1441	
BELINA II	->	REPARO DO CILINDRO DE RODA 19,05mm	1978/1991	SIST. VARGA	C-1481	
BELINA II	->	REPARO DO CILINDRO DE RODA 15,87mm	1984/1987	C/ TRAÇÃO 4X4	C-1489	
BELINA II	->	COPO DO CILINDRO DE RODA 22,22mm	1978/1979	P/ CILINDRO BENDIX 7/8"	CO-1315	
BELINA II	->	GAXETA DO CILINDRO DE RODA 22,22mm	1978/1979	P/ CILINDRO VARGA 7/8"	GA-0316	
BELINA II	->	COPO DO CILINDRO DE RODA 20,63mm	1978/1981	P/ CILINDRO BENDIX 13/16"	CO-1317	
BELINA II	->	COPO DO CILINDRO DE RODA 19,05mm	1978/1991	SIST. BENDIX	CO-1312	
BELINA II	->	GAXETA DO CILINDRO DE RODA 19,05mm	1978/1991	SIST. VARGA	GA-0307	
BELINA II	->	COPO DO CILINDRO DE RODA 15,87mm	1984/1987	C/ TRAÇÃO 4X4	CO-1306	
BELINA II	->	TAPA-PÓ DO CILINDRO DE RODA	1978/1991	SIST. BENDIX	TA-0310	
BELINA II	->	TAPA-PÓ DO CILINDRO DE RODA	1978/1991	SIST. VARGA	TA-0312	
CORCEL		CILINDRO MESTRE SIMPLES 19,05mm	1968/1976		C-2048	

BUSCA POR VEÍCULOS

Tabela de Conversão	Polegadas	9/16"	5/8"	11/16"	7/10"	3/4"	13/16"	7/8"	15/16"	1"	1 1/16"	1 1/8"	1 1/4"	1 3/8"	1 1/2"	1 5/8"	1 3/4"	1 27/32"	2"
	Milímetros	14,28mm	15,87mm	17,46mm	17,78mm	19,05mm	20,63mm	22,22mm	23,81mm	25,40mm	26,98mm	28,57mm	31,75mm	34,92mm	38,10mm	41,27mm	44,45mm	46,83mm	50,80mm

VEÍCULO		DESCRIÇÃO	ANOS	OBSERVAÇÃO	REF.	IMAGEM
<b>FORD</b>						
CORCEL		REPARO DO CILINDRO MESTRE SIMPLES 19,05mm	1968/1976		C-1062	
CORCEL		REPARO DO CILINDRO MESTRE DUPLO 19,05mm	1977/1977		C-1099	
CORCEL		RESERVATÓRIO C/ TAMP A E AVISO DE NÍVEL	1977/1977		C-0102	
CORCEL		VEDANTE DO CILINDRO MESTRE	1977/1977		VE-0201	
CORCEL	<-	REPARO DE VEDAÇÃO DA PINÇA 48,00mm	1968/1977		C-1479	
CORCEL	->	REPARO DO CILINDRO DE RODA 15,87mm	1968/1977		C-1489	
CORCEL	->	COPO DO CILINDRO DE RODA 15,87mm	1968/1977		CO-1306	
CORCEL	->	TAPA-PÓ DO CILINDRO DE RODA	1968/1977		TA-0310	
CORCEL II		SERVO FREIO 200mm	1980/1986		C-5601	
CORCEL II		VÁLVULA DE RETENÇÃO DE VÁCUO BRANCA	1978/1986	P/ SERVO VARGA FD30/FD150/SM180	C-1750	
CORCEL II		VÁLVULA DE RETENÇÃO DE VÁCUO	1980/1986		C-1753	
CORCEL II		CILINDRO MESTRE DUPLO 22,22mm	1978/1986	C/SERVO	C-2002	
CORCEL II		REPARO DO CILINDRO MESTRE DUPLO 19,05mm	1978/1980	S/SERVO	C-1099	
CORCEL II		REPARO DO CILINDRO MESTRE DUPLO 22,22mm	1978/1986		C-1019	
CORCEL II		REPARO DO CILINDRO MESTRE DUPLO 20,63mm	1978/1986	P/ CILINDRO VARGA 13/16"	C-1047	
CORCEL II		RESERVATÓRIO C/ TAMP A E AVISO DE NÍVEL	1978/1986		C-0102	
CORCEL II		VEDANTE DO CILINDRO MESTRE	1978/1986		VE-0201	
CORCEL II	<-	REPARO DE VEDAÇÃO DA PINÇA 48,00mm	1978/1986	SIST. BENDIX COIFA C/ ENCAIXE INTERNO	C-1421	
CORCEL II	<-	REPARO DE VEDAÇÃO DA PINÇA 48,00mm	1978/1986	SIST. BENDIX COIFA C/ ENCAIXE EXTERNO	C-1479	
CORCEL II	<-	REPARO DE VEDAÇÃO DA PINÇA 48,00mm	1981/1986	SIST. ATE (2 RODAS)	C-1434	
CORCEL II	->	CILINDRO DE RODA ESQUERDA 19,05mm	1978/1986	SIST. BENDIX	C-3358	
CORCEL II	->	CILINDRO DE RODA DIREITA 19,05mm	1978/1986	SIST. BENDIX	C-3359	
CORCEL II	->	CILINDRO DE RODA ESQUERDA 19,05mm	1978/1986	SIST. VARGA	C-3397	
CORCEL II	->	CILINDRO DE RODA DIREITA 19,05mm	1978/1986	SIST. VARGA	C-3398	
CORCEL II	->	REPARO DO CILINDRO DE RODA 20,63mm	1978/1979	P/ CILINDRO VARGA 13/16"	C-1509	
CORCEL II	->	REPARO DO CILINDRO DE RODA 20,63mm	1978/1981	P/ CILINDRO BENDIX 13/16"	C-1510	
CORCEL II	->	REPARO DO CILINDRO DE RODA 19,05mm	1978/1986	SIST. BENDIX	C-1441	
CORCEL II	->	REPARO DO CILINDRO DE RODA 19,05mm	1978/1986	SIST. VARGA	C-1481	
CORCEL II	->	GAXETA DO CILINDRO DE RODA 20,63mm	1978/1979	P/ CILINDRO VARGA 13/16"	GA-0206	
CORCEL II	->	COPO DO CILINDRO DE RODA 20,63mm	1978/1981	P/ CILINDRO BENDIX 13/16"	CO-1317	
CORCEL II	->	COPO DO CILINDRO DE RODA 19,05mm	1978/1986	SIST. BENDIX	CO-1312	
CORCEL II	->	GAXETA DO CILINDRO DE RODA 19,05mm	1978/1986	SIST. VARGA	GA-0307	
CORCEL II	->	TAPA-PÓ DO CILINDRO DE RODA	1978/1986	SIST. BENDIX	TA-0310	

Tabela de Conversão	Polegadas	9/16"	5/8"	11/16"	7/10"	3/4"	13/16"	7/8"	15/16"	1"	1 1/16"	1 1/8"	1 1/4"	1 3/8"	1 1/2"	1 5/8"	1 3/4"	1 27/32"	2"
	Milímetros	14,28mm	15,87mm	17,46mm	17,78mm	19,05mm	20,63mm	22,22mm	23,81mm	25,40mm	26,98mm	28,57mm	31,75mm	34,92mm	38,10mm	41,27mm	44,45mm	46,83mm	50,80mm

VEÍCULO		DESCRIÇÃO	ANOS	OBSERVAÇÃO	REF.	IMAGEM
<b>FORD</b>						
CORCEL II	->	TAPA-PÓ DO CILINDRO DE RODA	1978/1986	SIST. VARGA	TA-0312	
COURIER		CILINDRO MESTRE DE EMBREAGEM 19,05mm	1998/1998		C-2641	
COURIER		CILINDRO MESTRE DE EMBREAGEM 19,05mm	1999/...		C-2643	
COURIER		CIL. ATUADOR CONCÊNTRICO DE EMBREAGEM	1998/...	COM ADAPTADOR	C-2711	
COURIER		SERVO FREIO 230mm	1998/...		C-5635	
COURIER		CILINDRO MESTRE DUPLA 23,81mm	1998/...		C-2091	
COURIER		REPARO DO CILINDRO MESTRE DUPLA 23,81mm	1998/...		C-1146	
COURIER		VEDANTE DO CILINDRO MESTRE	1998/...		VE-0204	
COURIER	<	REPARO DE VEDAÇÃO DA PINÇA 54,00mm	1998/...		C-1419	
COURIER	->	CILINDRO DE RODA 22,22mm	1998/...		C-3470	
COURIER	->	REPARO DO CILINDRO DE RODA 22,22mm	1998/...		C-1582	
COURIER	->	GAXETA DO CILINDRO DE RODA 22,22mm	1998/...		GA-0207	
COURIER	->	TAPA-PÓ DO CILINDRO DE RODA	1998/...		TA-0312	
DEL REY		SERVO FREIO 200mm	1981/1991		C-5601	
DEL REY		VÁLVULA DE RETENÇÃO DE VÁCUO BRANCA	1981/1991	P/ SERVO VARGA SM180	C-1750	
DEL REY		VÁLVULA DE RETENÇÃO DE VÁCUO	1981/1991		C-1753	
DEL REY		CILINDRO MESTRE DUPLA 22,22mm	1981/1991		C-2002	
DEL REY		REPARO DO CILINDRO MESTRE DUPLA 22,22mm	1981/1991		C-1019	
DEL REY		REPARO DO CILINDRO MESTRE DUPLA 20,63mm	1981/1991	P/ CILINDRO VARGA 13/16"	C-1047	
DEL REY		RESERVATÓRIO C/ TAMPÃO E AVISO DE NÍVEL	1981/1991		C-0102	
DEL REY		VEDANTE DO CILINDRO MESTRE	1981/1991		VE-0201	
DEL REY	<	REPARO DE VEDAÇÃO DA PINÇA 48,00mm	1981/1989	SIST. BENDIX COIFA C/ ENCAIXE INTERNO	C-1421	
DEL REY	<	REPARO DE VEDAÇÃO DA PINÇA 48,00mm	1981/1989	SIST. ATE (2 RODAS)	C-1434	
DEL REY	<	REPARO DE VEDAÇÃO DA PINÇA 48,00mm	1981/1989	SIST. BENDIX COIFA C/ ENCAIXE EXTERNO	C-1479	











BUSCA POR VEÍCULOS

Tabela de Conversão	Polegadas	9/16"	5/8"	11/16"	7/10"	3/4"	13/16"	7/8"	15/16"	1"	1 1/16"	1 1/8"	1 1/4"	1 3/8"	1 1/2"	1 5/8"	1 3/4"	1 27/32"	2"
	Milímetros	14,28mm	15,87mm	17,46mm	17,78mm	19,05mm	20,63mm	22,22mm	23,81mm	25,40mm	26,98mm	28,57mm	31,75mm	34,92mm	38,10mm	41,27mm	44,45mm	46,83mm	50,80mm



VEÍCULO		DESCRIÇÃO	ANOS	OBSERVAÇÃO	REF.	IMAGEM
<b>FORD</b>						
DEL REY	<-	REPARO DE VEDAÇÃO DA PINÇA 48,00mm	1983/1991	SIST. VARGA	C-1413	
DEL REY	<-	TAPA PÓ DO PINO DE GUIA	1983/1991	SIST. VARGA	TA-0322	
DEL REY	->	CILINDRO DE RODA ESQUERDA 19,05mm	1981/1991	SIST. BENDIX	C-3358	
DEL REY	->	CILINDRO DE RODA DIREITA 19,05mm	1981/1991	SIST. BENDIX	C-3359	
DEL REY	->	CILINDRO DE RODA ESQUERDA 19,05mm	1981/1991	SIST. VARGA	C-3397	
DEL REY	->	CILINDRO DE RODA DIREITA 19,05mm	1981/1991	SIST. VARGA	C-3398	
DEL REY	->	REPARO DO CILINDRO DE RODA 19,05mm	1981/1991	SIST. BENDIX	C-1441	
DEL REY	->	REPARO DO CILINDRO DE RODA 19,05mm	1981/1991	SIST. VARGA	C-1481	
DEL REY	->	REPARO DO CILINDRO DE RODA 22,22mm	1983/1991	C/ CÂMBIO AUTOMÁTICO	C-1442	
DEL REY	->	COPO DO CILINDRO DE RODA 19,05mm	1981/1991	SIST. BENDIX	CO-1312	
DEL REY	->	GAXETA DO CILINDRO DE RODA 19,05mm	1981/1991	SIST. VARGA	GA-0307	
DEL REY	->	COPO DO CILINDRO DE RODA 22,22mm	1983/1991	C/ CÂMBIO AUTOMÁTICO	CO-1315	
DEL REY	->	TAPA-PÓ DO CILINDRO DE RODA	1981/1991	SIST. BENDIX	TA-0310	
DEL REY	->	TAPA-PÓ DO CILINDRO DE RODA	1981/1991	SIST. VARGA	TA-0312	
ECOSPORT		CILINDRO MESTRE DE EMBREAGEM 19,05mm	2003/2012		C-2661	
ECOSPORT		CIL. ATUADOR CONCÊNTRICO DE EMBREAGEM	2003/2009	TRAÇÃO 4X2 / SEM ADAPTADOR	C-2711	
ECOSPORT		SERVO FREIO 230mm	2003/2012	S/ABS	C-5667	
ECOSPORT		CILINDRO MESTRE DUPLA 23,81mm	2003/2012	S/ABS	C-2155	
ECOSPORT		REPARO DO CILINDRO MESTRE DUPLA 23,81mm	2003/2012	S/ABS	C-1175	
ECOSPORT	<-	REPARO DE VEDAÇÃO DA PINÇA 54,00mm	2003/2012		C-1419	
ECOSPORT	->	CILINDRO DE RODA 20,63mm	2003/2012	4X2 S/ABS	C-3496	

Tabela de Conversão	Polegadas	9/16"	5/8"	11/16"	7/10"	3/4"	13/16"	7/8"	15/16"	1"	1 1/16"	1 1/8"	1 1/4"	1 3/8"	1 1/2"	1 5/8"	1 3/4"	1 27/32"	2"
	Milímetros	14,28mm	15,87mm	17,46mm	17,78mm	19,05mm	20,63mm	22,22mm	23,81mm	25,40mm	26,98mm	28,57mm	31,75mm	34,92mm	38,10mm	41,27mm	44,45mm	46,83mm	50,80mm

VEÍCULO		DESCRIÇÃO	ANOS	OBSERVAÇÃO	REF.	IMAGEM
<b>FORD</b>						
ECOSPORT	->	CILINDRO DE RODA 22,22mm	2004/2012	4X4	C-3470	
ECOSPORT	->	CILINDRO DE RODA 19,05mm	2006/2012	4X2 C/ABS	C-3472	
ECOSPORT	->	CILINDRO DE RODA 20,63mm	2013/...	4X2 / 4X4	C-3546	
ECOSPORT	->	REPARO DO CILINDRO DE RODA 20,63mm	2003/2012	4X2 S/ABS	C-1555	
ECOSPORT	->	REPARO DO CILINDRO DE RODA 22,22mm	2004/2012	4X4	C-1582	
ECOSPORT	->	REPARO DO CILINDRO DE RODA 19,05mm	2006/2012	4X2 C/ABS	C-1556	
ECOSPORT	->	GAXETA DO CILINDRO DE RODA 20,63mm	2003/2012	4X2 S/ABS	GA-0217	
ECOSPORT	->	GAXETA DO CILINDRO DE RODA 22,22mm	2004/2012	4X4	GA-0207	
ECOSPORT	->	GAXETA DO CILINDRO DE RODA 19,05mm	2006/2012	4X2 C/ABS	GA-0320	
ECOSPORT	->	TAPA-PÓ DO CILINDRO DE RODA	2003/2012	4X2	TA-0303	
ECOSPORT	->	TAPA-PÓ DO CILINDRO DE RODA	2004/2012	4X4	TA-0312	
ESCORT		CILINDRO MESTRE DE EMBREAGEM 19,05mm	2001/2003	MOTOR 1.6 8V	C-2643	
ESCORT		CIL. ATUADOR CONCÊNTRICO DE EMBREAGEM	2001/2003	MOTOR 1.6 8v / COM ADAPTADOR	C-2711	
ESCORT		SERVO FREIO 200mm	1983/1992	SIST. BENDIX	C-5603	
ESCORT		SERVO FREIO 230mm	1993/1996	SIST. VARGA	C-5623	
ESCORT		SERVO FREIO 230mm	1993/1996	SIST. BOSCH	C-5624	
ESCORT		SERVO FREIO 230mm	1997/2003		C-5640	

BUSCA POR VEÍCULOS

Tabela de Conversão	Polegadas	9/16"	5/8"	11/16"	7/10"	3/4"	13/16"	7/8"	15/16"	1"	1 1/16"	1 1/8"	1 1/4"	1 3/8"	1 1/2"	1 5/8"	1 3/4"	1 27/32"	2"
	Milímetros	14,28mm	15,87mm	17,46mm	17,78mm	19,05mm	20,63mm	22,22mm	23,81mm	25,40mm	26,98mm	28,57mm	31,75mm	34,92mm	38,10mm	41,27mm	44,45mm	46,83mm	50,80mm



VEÍCULO		DESCRIÇÃO	ANOS	OBSERVAÇÃO	REF.	IMAGEM
<b>FORD</b>						
ESCORT		CILINDRO MESTRE DUPL0 22,00mm	1983/1992	SIST. BENDIX	C-2008	
ESCORT		CILINDRO MESTRE DUPL0 23,81mm	1993/1996	SIST. VARGA	C-2038	
ESCORT		CILINDRO MESTRE DUPL0 23,81mm	1993/2003	SIST. BOSCH	C-2051	
ESCORT		REPARO DO CILINDRO MESTRE DUPL0 22,00mm	1983/1992	SIST. BENDIX	C-1012	
ESCORT		REPARO DO CILINDRO MESTRE DUPL0 23,81mm	1993/1996	SIST. VARGA	C-1127	
ESCORT		REPARO DO CILINDRO MESTRE DUPL0 23,81mm	1993/2003	SIST. BOSCH	C-1128	
ESCORT		VEDANTE DO CILINDRO MESTRE	1983/1992	SIST. BENDIX	VE-0204	
ESCORT		VEDANTE DO CILINDRO MESTRE	1993/2003		VE-0204	
ESCORT	<-	REPARO DE VEDAÇÃO DA PINÇA 54,00mm	1983/1996	SIST. ATE	C-1419	
ESCORT	<-	REPARO DE VEDAÇÃO DA PINÇA 60,00mm	1993/1996	MOD. XR3	C-1545	
ESCORT	<-	REPARO DE VEDAÇÃO DA PINÇA 54,00mm	1993/2003	SIST. BOSCH	C-1575	
ESCORT	->	CILINDRO DE RODA 17,78mm	1983/1992		C-3439	
ESCORT	->	CILINDRO DE RODA 19,05mm	1993/1996	SIST. VARGA	C-3412	
ESCORT	->	CILINDRO DE RODA ESQUERDA 19,05mm	1993/1996	SIST. BOSCH	C-3435	
ESCORT	->	CILINDRO DE RODA DIREITA 19,05mm	1993/1996	SIST. BOSCH	C-3436	
ESCORT	->	CILINDRO DE RODA 20,63mm	1997/2003		C-3462	
ESCORT	->	REPARO DO CILINDRO DE RODA 17,78mm	1983/1992	P/ CIL. VARGA RCCR 0094.5	C-1420	
ESCORT	->	REPARO DO CILINDRO DE RODA 17,78mm	1983/1992		C-1566	
ESCORT	->	REPARO DO CILINDRO DE RODA 19,05mm	1993/1996	SIST. VARGA	C-1481	
ESCORT	->	REPARO DO CILINDRO DE RODA 19,05mm	1993/1996	SIST. BOSCH	C-1554	
ESCORT	->	REPARO DO CILINDRO DE RODA 20,63mm	1997/2003		C-1578	
ESCORT	->	GAXETA DO CILINDRO DE RODA 17,78mm	1983/1992		GA-0301	
ESCORT	->	COPO DO CILINDRO DE RODA 19,05mm	1993/1996	SIST. BOSCH	CO-1312	
ESCORT	->	GAXETA DO CILINDRO DE RODA 19,05mm	1993/1996	SIST. VARGA	GA-0307	
ESCORT	->	GAXETA DO CILINDRO DE RODA 20,63mm	1997/2003		GA-0206	

Tabela de Conversão	Polegadas	9/16"	5/8"	11/16"	7/10"	3/4"	13/16"	7/8"	15/16"	1"	1 1/16"	1 1/8"	1 1/4"	1 3/8"	1 1/2"	1 5/8"	1 3/4"	1 27/32"	2"
	Milímetros	14,28mm	15,87mm	17,46mm	17,78mm	19,05mm	20,63mm	22,22mm	23,81mm	25,40mm	26,98mm	28,57mm	31,75mm	34,92mm	38,10mm	41,27mm	44,45mm	46,83mm	50,80mm

VEÍCULO		DESCRIÇÃO	ANOS	OBSERVAÇÃO	REF.	IMAGEM
<b>FORD</b>						
ESCORT	->	TAPA-PÓ DO CILINDRO DE RODA	1983/1992		TA-0312	
ESCORT	->	TAPA-PÓ DO CILINDRO DE RODA	1983/1992	P/ CIL. VARGA RCCR 0094.5	TA-0317	
ESCORT	->	TAPA-PÓ DO CILINDRO DE RODA	1993/1996	SIST. BOSCH	TA-0321	
ESCORT	->	TAPA-PÓ DO CILINDRO DE RODA	1993/2003	SIST. VARGA	TA-0312	
ESCORT	->	REPARO DE VEDAÇÃO DA PINÇA 33,00mm	1993/1996		C-1546	
ESCORT HOBBY		SERVO FREIO 200mm	1993/1996		C-5603	
ESCORT HOBBY		CILINDRO MESTRE DUPLO 22,00mm	1993/1996		C-2008	
ESCORT HOBBY		REPARO DO CILINDRO MESTRE DUPLO 22,00mm	1993/1996		C-1012	
ESCORT HOBBY		VEDANTE DO CILINDRO MESTRE	1993/1996		VE-0204	
ESCORT HOBBY	<-	REPARO DE VEDAÇÃO DA PINÇA 54,00mm	1993/1996		C-1419	
ESCORT HOBBY	->	CILINDRO DE RODA 17,78mm	1993/1996		C-3439	
ESCORT HOBBY	->	REPARO DO CILINDRO DE RODA 17,78mm	1993/1996	P/ CIL. VARGA RCCR 0094.5	C-1420	
ESCORT HOBBY	->	REPARO DO CILINDRO DE RODA 17,78mm	1993/1996		C-1566	
ESCORT HOBBY	->	GAXETA DO CILINDRO DE RODA 17,78mm	1993/1996		GA-0301	
ESCORT HOBBY	->	TAPA-PÓ DO CILINDRO DE RODA	1993/1996		TA-0312	
ESCORT HOBBY	->	TAPA-PÓ DO CILINDRO DE RODA	1993/1996	P/ CIL. VARGA RCCR 0094.5	TA-0317	
ESCORT SW		CILINDRO MESTRE DE EMBREAGEM 19,05mm	2001/2003	MOTOR 1.6 8V	C-2643	
ESCORT SW		CIL. ATUADOR CONCÊNTRICO DE EMBREAGEM	2001/2003	MOTOR 1.6 8V / COM ADAPTADOR	C-2711	
ESCORT SW		SERVO FREIO 230mm	1997/2003		C-5640	
ESCORT SW		CILINDRO MESTRE DUPLO 23,81mm	1997/2003		C-2051	
ESCORT SW		REPARO DO CILINDRO MESTRE DUPLO 23,81mm	1997/2003		C-1128	
ESCORT SW		VEDANTE DO CILINDRO MESTRE	1997/2003		VE-0204	
ESCORT SW	<-	REPARO DE VEDAÇÃO DA PINÇA 54,00mm	1997/2003		C-1575	
ESCORT SW	->	CILINDRO DE RODA 20,63mm	1997/2003		C-3462	
ESCORT SW	->	REPARO DO CILINDRO DE RODA 20,63mm	1997/2003		C-1578	
ESCORT SW	->	GAXETA DO CILINDRO DE RODA 20,63mm	1997/2003		GA-0206	

BUSCA POR VEÍCULOS

Tabela de Conversão	Polegadas	9/16"	5/8"	11/16"	7/10"	3/4"	13/16"	7/8"	15/16"	1"	1 1/16"	1 1/8"	1 1/4"	1 3/8"	1 1/2"	1 5/8"	1 3/4"	1 27/32"	2"
	Milímetros	14,28mm	15,87mm	17,46mm	17,78mm	19,05mm	20,63mm	22,22mm	23,81mm	25,40mm	26,98mm	28,57mm	31,75mm	34,92mm	38,10mm	41,27mm	44,45mm	46,83mm	50,80mm

VEÍCULO		DESCRIÇÃO	ANOS	OBSERVAÇÃO	REF.	IMAGEM
<b>FORD</b>						
ESCORT SW	->	TAPA-PÓ DO CILINDRO DE RODA	1997/2003		TA-0312	
EXPLORER		CIL. ATUADOR CONCÊNTRICO DE EMBREAGEM	1995/2005		C-2702	
EXPLORER		CILINDRO MESTRE DUPLA 26,98mm C / RESERV.	1995/1997		C-2132	
EXPLORER	<-	REPARO DE VEDAÇÃO DA PINÇA 46,00mm	1995/2005		C-1592	
F-75		CILINDRO MESTRE SIMPLES 25,40mm	1960/1982		C-2036	
F-75		REPARO DO CILINDRO MESTRE SIMPLES 25,40mm	1960/1982		C-1013	
F-75	<-	CILINDRO DE RODA ESQUERDA 28,57mm	1960/1982		C-3390	
F-75	<-	CILINDRO DE RODA DIREITA 28,57mm	1960/1982		C-3391	
F-75	<-	REPARO DO CILINDRO DE RODA 28,57mm	1960/1982		C-1422	
F-75	<-	COPO DO CILINDRO DE RODA 28,57mm	1960/1982		CO-1309	
F-75	<-	TAPA-PÓ DO CILINDRO DE RODA	1960/1982		TA-0349	
F-75	->	CILINDRO DE RODA ESQUERDA 25,40mm	1960/1961	C/ FREIO ESTAC. NO CARDAN	C-3380	
F-75	->	CILINDRO DE RODA DIREITA 25,40mm	1960/1961	C/ FREIO ESTAC. NO CARDAN	C-3381	
F-75	->	CILINDRO DE RODA ESQUERDA 25,40mm	1960/1982		C-3392	
F-75	->	CILINDRO DE RODA DIREITA 25,40mm	1960/1982		C-3393	
F-75	->	REPARO DO CILINDRO DE RODA 25,40mm	1960/1961	C/ FREIO ESTAC. NO CARDAN	C-1435	
F-75	->	REPARO DO CILINDRO DE RODA 25,40mm	1960/1982		C-1416	
F-75	->	COPO DO CILINDRO DE RODA 25,40mm	1960/1982		CO-1307	
F-75	->	TAPA-PÓ DO CILINDRO DE RODA	1960/1961	C/ FREIO ESTAC. NO CARDAN	TA-0320	
F-75	->	TAPA-PÓ DO CILINDRO DE RODA	1960/1982		TA-0314	
F-100		REPARO DO CIL. MESTRE DE EMBREAGEM 26,98mm	1962/1971		C-1601	

Tabela de Conversão	Polegadas	9/16"	5/8"	11/16"	7/10"	3/4"	13/16"	7/8"	15/16"	1"	1 1/16"	1 1/8"	1 1/4"	1 3/8"	1 1/2"	1 5/8"	1 3/4"	1 27/32"	2"
	Milímetros	14,28mm	15,87mm	17,46mm	17,78mm	19,05mm	20,63mm	22,22mm	23,81mm	25,40mm	26,98mm	28,57mm	31,75mm	34,92mm	38,10mm	41,27mm	44,45mm	46,83mm	50,80mm











VEÍCULO		DESCRIÇÃO	ANOS	OBSERVAÇÃO	REF.	IMAGEM
<b>FORD</b>						
F-100		REPARO DO CIL. AUXILIAR DE EMBREAGEM 25,40mm	1962/1971		C-1602	
F-100		SERVO FREIO 200mm	1979/1987		C-5617	
F-100		VÁLVULA DE RETENÇÃO DE VÁCUO	1979/1987		C-1755	
F-100		CILINDRO MESTRE DUPLA 25,40mm	1982/1984	USE C/ RESERV. C-0105	C-2039	
F-100		CILINDRO MESTRE DUPLA 25,40mm	1985/1987		C-2039	
F-100		REPARO DO CILINDRO MESTRE SIMPLES 26,98mm	1956/1962		C-1053	
F-100		REPARO DO CILINDRO MESTRE SIMPLES 25,40mm	1962/1976		C-1103	
F-100		REPARO DO CILINDRO MESTRE SIMPLES 22,22mm	1976/1982		C-1093	
F-100		REPARO DO CILINDRO MESTRE DUPLA 25,40mm	1982/1987		C-1092	
F-100		RESERVATÓRIO C/ TAMPA	1982/1987		C-0105	
F-100		VEDANTE DO CILINDRO MESTRE	1982/1987		VE-0203	
F-100	<	REPARO DO CILINDRO DE RODA 28,57mm	1956/1982		C-1408	
F-100	<	COPO DO CILINDRO DE RODA 28,57mm	1956/1982		CO-1309	
F-100	<	TAPA-PÓ DO CILINDRO DE RODA	1956/1982		TA-0314	
F-100	<	REPARO DE VEDAÇÃO DA PINÇA 79,00mm	1982/1987	(2 RODAS)	C-1500	
F-100	>	CILINDRO DE RODA ESQUERDA 22,22mm	1968/1987		C-3460	
F-100	>	CILINDRO DE RODA DIREITA 22,22mm	1968/1987		C-3461	
F-100	>	REPARO DO CILINDRO DE RODA 22,22mm	1956/1987		C-1407	
F-100	>	COPO DO CILINDRO DE RODA 22,22mm	1956/1987		CO-1315	
F-100	>	TAPA-PÓ DO CILINDRO DE RODA	1956/1987		TA-0314	
F-250	<	REPARO DE VEDAÇÃO DA PINÇA 54,00mm	1999/2012		C-1599	
F-250	>	CILINDRO DE RODA ESQUERDA 28,57mm	1999/2012		C-3494	
F-250	>	CILINDRO DE RODA DIREITA 28,57mm	1999/2012		C-3495	
F-250	>	REPARO DO CILINDRO DE RODA 28,57mm	1999/2012		C-1422	
F-250	>	COPO DO CILINDRO DE RODA 28,57mm	1999/2012		CO-1309	
F-250	>	TAPA-PÓ DO CILINDRO DE RODA	1999/2012		TA-0349	

BUSCA POR VEÍCULOS

Tabela de Conversão	Polegadas	9/16"	5/8"	11/16"	7/10"	3/4"	13/16"	7/8"	15/16"	1"	1 1/16"	1 1/8"	1 1/4"	1 3/8"	1 1/2"	1 5/8"	1 3/4"	1 27/32"	2"
	Milímetros	14,28mm	15,87mm	17,46mm	17,78mm	19,05mm	20,63mm	22,22mm	23,81mm	25,40mm	26,98mm	28,57mm	31,75mm	34,92mm	38,10mm	41,27mm	44,45mm	46,83mm	50,80mm

VEÍCULO		DESCRIÇÃO	ANOS	OBSERVAÇÃO	REF.	IMAGEM
<b>FORD</b>						
F-1000		CILINDRO MESTRE DE EMBREAGEM 19,05mm	1995/1998	MOTOR 4.9 GASOLINA/2.5 HSD DIESEL	C-2629	
F-1000		CILINDRO MESTRE DE EMBREAGEM 22,22mm	1996/1998	MOTOR MWM 4.3 DIESEL	C-2628	
F-1000		CIL. ATUADOR CONCÊNTRICO DE EMBREAGEM	1995/1998	MOTOR 4.9 GASOLINA/2.5 HSD DIESEL	C-2702	
F-1000		CILINDRO AUXILIAR DE EMBREAGEM 22,22mm	1996/1998	MOTOR MWM 4.3 DIESEL	C-2613	
F-1000		REPARO DO CIL. MESTRE DE EMBREAGEM 19,05mm	1995/1998	MOTOR 4.9 GASOLINA/2.5 HSD DIESEL	C-1637	
F-1000		REPARO DO CIL. MESTRE DE EMBREAGEM 22,22mm	1996/1998	MOTOR MWM 4.3 DIESEL	C-1636	
F-1000		REPARO DO CIL. AUXILIAR DE EMBREAGEM 22,22mm	1998/1998	MOTOR MWM 4.3 DIESEL	C-1630	
F-1000		VEDANTE DO CILINDRO MESTRE	1995/1998		VE-0204	
F-1000		SERVO FREIO 200mm	1979/1992		C-5617	
F-1000		VÁLVULA DE RETENÇÃO DE VÁCUO	1979/1992		C-1755	
F-1000		CILINDRO MESTRE DUPL0 25,40mm	1979/1984	USE C/ RESERV. C-0105	C-2039	
F-1000		CILINDRO MESTRE DUPL0 25,40mm	1985/1992		C-2039	
F-1000		CILINDRO MESTRE DUPL0 28,57mm	1992/1998		C-2062	
F-1000		REPARO DO CILINDRO MESTRE DUPL0 25,40mm	1979/1992		C-1092	
F-1000		REPARO DO CILINDRO MESTRE DUPL0 28,57mm	1992/1998		C-1125	
F-1000		RESERVATÓRIO C/ TAMPA	1979/1987		C-0105	
F-1000		RESERVATÓRIO C/ TAMPA E AVISO DE NÍVEL	1988/1998		C-0111	
F-1000		VEDANTE DO CILINDRO MESTRE	1979/1998		VE-0203	
F-1000	<-	REPARO DE VEDAÇÃO DA PINÇA 79,00mm	1979/1994	C/ TRACÇÃO 4X2 (2 RODAS)	C-1500	
F-1000	<-	REPARO DE VEDAÇÃO DA PINÇA 54,00mm	1993/1998	C/ TRACÇÃO 4X4	C-1542	
F-1000	<-	REPARO DE VEDAÇÃO DA PINÇA 54,00mm	1995/1998	C/ TRACÇÃO 4X2	C-1542	
F-1000	<-	TAPA-PÓ DO PINO DE GUIA	1993/1998	C/ TRACÇÃO 4X4	TA-1312	
F-1000	<-	TAPA-PÓ DO PINO DE GUIA	1995/1998	C/ TRACÇÃO 4X2	TA-1312	

Tabela de Conversão	Polegadas	9/16"	5/8"	11/16"	7/10"	3/4"	13/16"	7/8"	15/16"	1"	1 1/16"	1 1/8"	1 1/4"	1 3/8"	1 1/2"	1 5/8"	1 3/4"	1 27/32"	2"
	Milímetros	14,28mm	15,87mm	17,46mm	17,78mm	19,05mm	20,63mm	22,22mm	23,81mm	25,40mm	26,98mm	28,57mm	31,75mm	34,92mm	38,10mm	41,27mm	44,45mm	46,83mm	50,80mm

VEÍCULO		DESCRIÇÃO	ANOS	OBSERVAÇÃO	REF.	IMAGEM
<b>FORD</b>						
F-1000	->	CILINDRO DE RODA ESQUERDA 25,40mm	1979/1998		C-3376	
F-1000	->	CILINDRO DE RODA DIREITA 25,40mm	1979/1998		C-3377	
F-1000	->	REPARO DO CILINDRO DE RODA 25,40mm	1979/1998		C-1416	
F-1000	->	COPO DO CILINDRO DE RODA 25,40mm	1979/1998		CO-1307	
F-1000	->	TAPA-PÓ DO CILINDRO DE RODA	1979/1998		TA-0314	
F-2000		SERVO FREIO 200mm	1980/1987		C-5617	
F-2000		VÁLVULA DE RETENÇÃO DE VÁCUO	1980/1987		C-1755	
F-2000		CILINDRO MESTRE DUPLO 25,40mm	1980/1984	USE C/ RESERV. C-0105	C-2039	
F-2000		CILINDRO MESTRE DUPLO 25,40mm	1985/1987		C-2039	
F-2000		REPARO DO CILINDRO MESTRE DUPLO 25,40mm	1980/1987		C-1092	
F-2000		RESERVATÓRIO C/ TAMPÁ	1980/1987		C-0105	
F-2000		VEDANTE DO CILINDRO MESTRE	1980/1987		VE-0203	
F-2000	<-	REPARO DE VEDAÇÃO DA PINÇA 79,00mm	1980/1987	(2 RODAS)	C-1500	
F-2000	->	REPARO DO CILINDRO DE RODA 23,81mm	1980/1987		C-1405	
F-2000	->	COPO DO CILINDRO DE RODA 23,81mm	1980/1987		CO-1311	
F-2000	->	TAPA-PÓ DO CILINDRO DE RODA	1980/1987		TA-0314	
FIESTA		CILINDRO MESTRE DE EMBREAGEM 19,05mm	1996/1998		C-2641	
FIESTA		CILINDRO MESTRE DE EMBREAGEM 19,05mm	1999/2002		C-2643	
FIESTA		CILINDRO MESTRE DE EMBREAGEM 19,05mm	2003/...		C-2661	
FIESTA		CIL. ATUADOR CONCÊNTRICO DE EMBREAGEM	1996/2002	COM ADAPTADOR	C-2711	

BUSCA POR VEÍCULOS

Tabela de Conversão	Polegadas	9/16"	5/8"	11/16"	7/10"	3/4"	13/16"	7/8"	15/16"	1"	1 1/16"	1 1/8"	1 1/4"	1 3/8"	1 1/2"	1 5/8"	1 3/4"	1 27/32"	2"
	Milímetros	14,28mm	15,87mm	17,46mm	17,78mm	19,05mm	20,63mm	22,22mm	23,81mm	25,40mm	26,98mm	28,57mm	31,75mm	34,92mm	38,10mm	41,27mm	44,45mm	46,83mm	50,80mm



VEÍCULO		DESCRIÇÃO	ANOS	OBSERVAÇÃO	REF.	IMAGEM
<b>FORD</b>						
FIESTA		CIL. ATUADOR CONCÊNTRICO DE EMBREAGEM	2003/2009	SEM ADAPTADOR	C-2711	
FIESTA		SERVO FREIO 200mm	1995/1995		C-5644	
FIESTA		SERVO FREIO 230mm	1996/2002		C-5635	
FIESTA		SERVO FREIO 230mm	2003/...	S/ABS	C-5667	
FIESTA		CILINDRO MESTRE DUPLO 22,22mm	1996/2002	MOTOR 1.0/1.3 SIST. VARGA	C-2061	
FIESTA		CILINDRO MESTRE DUPLO 23,81mm	1996/2002	MOTOR 1.4/1.6 SIST. VARGA	C-2091	
FIESTA		CILINDRO MESTRE DUPLO 23,81mm	2003/...	MOTOR 1.6/1.0 SUPERCHARGER S/ABS	C-2155	
FIESTA		CILINDRO MESTRE DUPLO 22,22mm	2003/...	MOTOR 1.0	C-2156	
FIESTA		REPARO DO CILINDRO MESTRE DUPLO 20,63mm	1995/1995		C-1138	
FIESTA		REPARO DO CILINDRO MESTRE DUPLO 22,22mm	1996/2002	MOTOR 1.0/1.3	C-1145	
FIESTA		REPARO DO CILINDRO MESTRE DUPLO 23,81mm	1996/2002	MOTOR 1.4/1.6	C-1146	
FIESTA		REPARO DO CILINDRO MESTRE DUPLO 23,81mm	2003/...	MOTOR 1.6/1.0 SUPERCHARGER S/ABS	C-1175	
FIESTA		VEDANTE DO CILINDRO MESTRE	1996/2002		VE-0204	
FIESTA	<-	REPARO DE VEDAÇÃO DA PINÇA 48,00mm	1995/2002	MOTOR 1.0/1.3	C-1443	
FIESTA	<-	REPARO DE VEDAÇÃO DA PINÇA 54,00mm	1996/2002	MOTOR 1.4/1.6	C-1419	
FIESTA	<-	REPARO DE VEDAÇÃO DA PINÇA 54,00mm	2003/...	MOTOR 1.6/1.0 SUPERCHARGER S/ABS	C-1419	
FIESTA	<-	REPARO DE VEDAÇÃO DA PINÇA 48,00mm	2003/...	MOTOR 1.0	C-1443	
FIESTA	->	CILINDRO DE RODA 19,00mm	1995/1995		C-3438	
FIESTA	->	CILINDRO DE RODA 19,05mm	1996/2002	MOTOR 1.4/1.6	C-3412	

Tabela de Conversão	Polegadas	9/16"	5/8"	11/16"	7/10"	3/4"	13/16"	7/8"	15/16"	1"	1 1/16"	1 1/8"	1 1/4"	1 3/8"	1 1/2"	1 5/8"	1 3/4"	1 27/32"	2"
	Milímetros	14,28mm	15,87mm	17,46mm	17,78mm	19,05mm	20,63mm	22,22mm	23,81mm	25,40mm	26,98mm	28,57mm	31,75mm	34,92mm	38,10mm	41,27mm	44,45mm	46,83mm	50,80mm

VEÍCULO		DESCRIÇÃO	ANOS	OBSERVAÇÃO	REF.	IMAGEM
<b>FORD</b>						
FIESTA	->	CILINDRO DE RODA 17,78mm	1996/2002	MOTOR 1.0/1.3	C-3439	
FIESTA	->	CILINDRO DE RODA 19,05mm	2003/2006	MOTOR 1.0	C-3472	
FIESTA	->	CILINDRO DE RODA 20,63mm	2003/2006	MOTOR 1.6/1.0 SUPERCHARGER	C-3496	
FIESTA	->	CILINDRO DE RODA 19,05mm	2007/...		C-3472	
FIESTA	->	REPARO DO CILINDRO DE RODA 19,00mm	1995/1995		C-1557	
FIESTA	->	REPARO DO CILINDRO DE RODA 19,05mm	1996/2002	MOTOR 1.4/1.6	C-1481	
FIESTA	->	REPARO DO CILINDRO DE RODA 17,78mm	1996/2002	MOTOR 1.0/1.3	C-1566	
FIESTA	->	REPARO DO CILINDRO DE RODA 20,63mm	2003/2006	MOTOR 1.6/1.0 SUPERCHARGER	C-1555	
FIESTA	->	REPARO DO CILINDRO DE RODA 19,05mm	2003/2006	MOTOR 1.0	C-1556	
FIESTA	->	REPARO DO CILINDRO DE RODA 19,05mm	2007/...		C-1556	
FIESTA	->	GAXETA DO CILINDRO DE RODA 19,05mm	1995/1995		GA-0320	
FIESTA	->	GAXETA DO CILINDRO DE RODA 17,78mm	1996/2002	MOTOR 1.0/1.3	GA-0301	
FIESTA	->	GAXETA DO CILINDRO DE RODA 19,05mm	1996/2002	MOTOR 1.4/1.6	GA-0307	
FIESTA	->	GAXETA DO CILINDRO DE RODA 20,63mm	2003/2006	MOTOR 1.6/1.0 SUPERCHARGER	GA-0217	
FIESTA	->	GAXETA DO CILINDRO DE RODA 19,05mm	2003/2006	MOTOR 1.0	GA-0320	
FIESTA	->	GAXETA DO CILINDRO DE RODA 19,05mm	2007/...		GA-0320	
FIESTA	->	TAPA-PÓ DO CILINDRO DE RODA	1995/1995		TA-0367	
FIESTA	->	TAPA-PÓ DO CILINDRO DE RODA	1996/2002		TA-0312	
FIESTA	->	TAPA-PÓ DO CILINDRO DE RODA	2003/...		TA-0303	
FIESTA SEDAN		CILINDRO MESTRE DE EMBREAGEM 19,05mm	2005/...		C-2661	
FIESTA SEDAN		CIL. ATUADOR CONCÊNTRICO DE EMBREAGEM	2005/2009	SEM ADAPTADOR	C-2711	
FIESTA SEDAN		SERVO FREIO 230mm	2005/...	S/ABS	C-5667	
FIESTA SEDAN		CILINDRO MESTRE DUPLO 23,81mm	2005/...	MOTOR 1.6/1.0 SUPERCHARGER S/ABS	C-2155	
FIESTA SEDAN		CILINDRO MESTRE DUPLO 22,22mm	2005/...	MOTOR 1.0	C-2156	
FIESTA SEDAN		REPARO DO CILINDRO MESTRE DUPLO 23,81mm	2005/...	MOTOR 1.6/1.0 SUPERCHARGER S/ABS	C-1175	

BUSCA POR VEÍCULOS

Tabela de Conversão	Polegadas	9/16"	5/8"	11/16"	7/10"	3/4"	13/16"	7/8"	15/16"	1"	1 1/16"	1 1/8"	1 1/4"	1 3/8"	1 1/2"	1 5/8"	1 3/4"	1 27/32"	2"
	Milímetros	14,28mm	15,87mm	17,46mm	17,78mm	19,05mm	20,63mm	22,22mm	23,81mm	25,40mm	26,98mm	28,57mm	31,75mm	34,92mm	38,10mm	41,27mm	44,45mm	46,83mm	50,80mm





















VEÍCULO		DESCRIÇÃO	ANOS	OBSERVAÇÃO	REF.	IMAGEM
<b>FORD</b>						
FIESTA SEDAN	<-	REPARO DE VEDAÇÃO DA PINÇA 54,00mm	2005/....		C-1419	
FIESTA SEDAN	->	CILINDRO DE RODA 20,63mm	2005/2006		C-3496	
FIESTA SEDAN	->	CILINDRO DE RODA 19,05mm	2007/...		C-3472	
FIESTA SEDAN	->	REPARO DO CILINDRO DE RODA 20,63mm	2005/2006		C-1555	
FIESTA SEDAN	->	REPARO DO CILINDRO DE RODA 19,05mm	2007/...		C-1556	
FIESTA SEDAN	->	GAXETA DO CILINDRO DE RODA 20,63mm	2005/2006		GA-0217	
FIESTA SEDAN	->	GAXETA DO CILINDRO DE RODA 19,05mm	2007/...		GA-0320	
FIESTA SEDAN	->	TAPA-PÓ DO CILINDRO DE RODA	2005/...		TA-0303	
FIESTA STREET HATCH		CILINDRO MESTRE DE EMBREAGEM 19,05mm	2001/2007		C-2643	
FIESTA STREET HATCH		CIL. ATUADOR CONCÊNTRICO DE EMBREAGEM	2001/2007	COM ADAPTADOR	C-2711	
FIESTA STREET HATCH		SERVO FREIO 230mm	2001/2007		C-5635	
FIESTA STREET HATCH		CILINDRO MESTRE DUPLA 22,22mm	2001/2007	MOTOR 1.0	C-2061	
FIESTA STREET HATCH		CILINDRO MESTRE DUPLA 23,81mm	2002/2007	MOTOR 1.6	C-2091	
FIESTA STREET HATCH		REPARO DO CILINDRO MESTRE DUPLA 22,22mm	2001/2007	MOTOR 1.0	C-1145	
FIESTA STREET HATCH		REPARO DO CILINDRO MESTRE DUPLA 23,81mm	2002/2007	MOTOR 1.6	C-1146	
FIESTA STREET HATCH		VEDANTE DO CILINDRO MESTRE	2001/2007		VE-0204	
FIESTA STREET HATCH	<-	REPARO DE VEDAÇÃO DA PINÇA 48,00mm	2001/2007	MOTOR 1.0	C-1443	
FIESTA STREET HATCH	<-	REPARO DE VEDAÇÃO DA PINÇA 54,00mm	2002/2007	MOTOR 1.6	C-1419	
FIESTA STREET HATCH	->	CILINDRO DE RODA 17,78mm	2001/2007	MOTOR 1.0	C-3439	
FIESTA STREET HATCH	->	CILINDRO DE RODA 19,05mm	2002/2007	MOTOR 1.6	C-3412	
FIESTA STREET HATCH	->	REPARO DO CILINDRO DE RODA 17,78mm	2001/2007	MOTOR 1.0	C-1566	

Tabela de Conversão	Polegadas	9/16"	5/8"	11/16"	7/10"	3/4"	13/16"	7/8"	15/16"	1"	1 1/16"	1 1/8"	1 1/4"	1 3/8"	1 1/2"	1 5/8"	1 3/4"	1 27/32"	2"
	Milímetros	14,28mm	15,87mm	17,46mm	17,78mm	19,05mm	20,63mm	22,22mm	23,81mm	25,40mm	26,98mm	28,57mm	31,75mm	34,92mm	38,10mm	41,27mm	44,45mm	46,83mm	50,80mm

VEÍCULO		DESCRIÇÃO	ANOS	OBSERVAÇÃO	REF.	IMAGEM
<b>FORD</b>						
FIESTA STREET HATCH	->	REPARO DO CILINDRO DE RODA 19,05mm	2002/2007	MOTOR 1.6	C-1481	
FIESTA STREET HATCH	->	GAXETA DO CILINDRO DE RODA 17,78mm	2001/2007	MOTOR 1.0	GA-0301	
FIESTA STREET HATCH	->	GAXETA DO CILINDRO DE RODA 19,05mm	2002/2007	MOTOR 1.6	GA-0307	
FIESTA STREET HATCH	->	TAPA-PÓ DO CILINDRO DE RODA	2001/2007		TA-0312	
FIESTA STREET SEDAN		CILINDRO MESTRE DE EMBREAGEM 19,05mm	2002/2004		C-2643	
FIESTA STREET SEDAN		CIL. ATUADOR CONCÊNTRICO DE EMBREAGEM	2002/2004	COM ADAPTADOR	C-2711	
FIESTA STREET SEDAN		SERVO FREIO 230mm	2002/2004		C-5635	
FIESTA STREET SEDAN		CILINDRO MESTRE DUPLO 23,81mm	2002/2004		C-2091	
FIESTA STREET SEDAN		REPARO DO CILINDRO MESTRE DUPLO 23,81mm	2002/2004		C-1146	
FIESTA STREET SEDAN		VEDANTE DO CILINDRO MESTRE	2002/2004		VE-0204	
FIESTA STREET SEDAN	<-	REPARO DE VEDAÇÃO DA PINÇA 54,00mm	2002/2004		C-1419	
FIESTA STREET SEDAN	->	CILINDRO DE RODA 19,05mm	2002/2004		C-3412	
FIESTA STREET SEDAN	->	REPARO DO CILINDRO DE RODA 19,05mm	2002/2004		C-1481	
FIESTA STREET SEDAN	->	GAXETA DO CILINDRO DE RODA 19,05mm	2002/2004		GA-0307	
FIESTA STREET SEDAN	->	TAPA-PÓ DO CILINDRO DE RODA	2002/2004		TA-0312	
FOCUS		CILINDRO MESTRE DE EMBREAGEM 19,05mm	.../2004	MOTOR 1.6 8V ZETEC ROCAM	C-2684	
FOCUS		CILINDRO MESTRE DE EMBREAGEM 19,05mm	2000/2007	MOTOR 1.8 E 2.0 16V ZETEC	C-2684	
FOCUS		CIL. ATUADOR CONCÊNTRICO DE EMBREAGEM	2001/2004	MOTOR 1.8 16V / COM ADAPTADOR	C-2711	
FOCUS		CIL. ATUADOR CONCÊNTRICO DE EMBREAGEM	2004/2009	MOTOR 1.6 8V / SEM ADAPTADOR	C-2711	

BUSCA POR VEÍCULOS

Tabela de Conversão	Polegadas	9/16"	5/8"	11/16"	7/10"	3/4"	13/16"	7/8"	15/16"	1"	1 1/16"	1 1/8"	1 1/4"	1 3/8"	1 1/2"	1 5/8"	1 3/4"	1 27/32"	2"
	Milímetros	14,28mm	15,87mm	17,46mm	17,78mm	19,05mm	20,63mm	22,22mm	23,81mm	25,40mm	26,98mm	28,57mm	31,75mm	34,92mm	38,10mm	41,27mm	44,45mm	46,83mm	50,80mm

VEÍCULO		DESCRIÇÃO	ANOS	OBSERVAÇÃO	REF.	IMAGEM
<b>FORD</b>						
FOCUS		CIL. ATUADOR CONCÊNTRICO DE EMBREAGEM	2005/2008	MOTOR 2.0 DURATEC / SEM ADAPTADOR	C-2711	
FOCUS		CIL. ATUADOR CONCÊNTRICO DE EMBREAGEM	2010/...	MOTOR 2.0 FLEX / SEM ADAPTADOR	C-2711	
FOCUS		CILINDRO MESTRE DUPL0 23,81mm	2001/2003	SIST. BOSCH S/ABS	C-2146	
FOCUS		CILINDRO MESTRE DUPL0 23,81mm	2003/2009	SIST. ATE S/ABS	C-2175	
FOCUS		CILINDRO MESTRE DUPL0 25,40mm	2008/2010	2.0 COM ABS	C-2185	
FOCUS		REPARO DO CILINDRO MESTRE DUPL0 23,81mm	2003/2009	SIST. ATE S/ABS	C-1175	
FOCUS		VEDANTE DO CILINDRO MESTRE	2001/2009		VE-0208	
FOCUS	->	CILINDRO DE RODA 20,63mm	2001/2005	MOTOR 1.8/2.0 16V	C-3462	
FOCUS	->	CILINDRO DE RODA 19,05mm	2003/2009	MOTOR 1.6 8V	C-3412	
FOCUS	->	CILINDRO DE RODA 20,63mm	2010/...	S/ABS	C-3539	
FOCUS	->	REPARO DO CILINDRO DE RODA 20,63mm	2001/2005	MOTOR 1.8/2.0 16V	C-1578	
FOCUS	->	REPARO DO CILINDRO DE RODA 19,05mm	2004/2009	MOTOR 1.6 8V	C-1481	
FOCUS	->	GAXETA DO CILINDRO DE RODA 20,63mm	2001/2005	MOTOR 1.8/2.0 16V	GA-0206	
FOCUS	->	GAXETA DO CILINDRO DE RODA 19,05mm	2004/2009	MOTOR 1.6 8V	GA-0307	
FOCUS	->	TAPA-PÓ DO CILINDRO DE RODA	2001/2009		TA-0312	
GALAXIE		VÁLVULA DE RETENÇÃO DE VÁCUO BRANCA	1977/1982		C-1750	
GALAXIE		VEDANTE DO CILINDRO MESTRE	1977/1982		VE-0200	
GALAXIE	<-	CILINDRO DE RODA ESQUERDA 28,57mm	1967/1968		C-3390	

Tabela de Conversão	Polegadas	9/16"	5/8"	11/16"	7/10"	3/4"	13/16"	7/8"	15/16"	1"	1 1/16"	1 1/8"	1 1/4"	1 3/8"	1 1/2"	1 5/8"	1 3/4"	1 27/32"	2"
	Milímetros		14,28mm	15,87mm	17,46mm	17,78mm	19,05mm	20,63mm	22,22mm	23,81mm	25,40mm	26,98mm	28,57mm	31,75mm	34,92mm	38,10mm	41,27mm	44,45mm	46,83mm

VEÍCULO		DESCRIÇÃO	ANOS	OBSERVAÇÃO	REF.	IMAGEM
<b>FORD</b>						
GALAXIE	<	CILINDRO DE RODA DIREITA 28,57mm	1967/1968		C-3391	
GALAXIE	<	REPARO DO CILINDRO DE RODA 28,57mm	1967/1971		C-1422	
GALAXIE	<	COPO DO CILINDRO DE RODA 28,57mm	1967/1971		CO-1309	
GALAXIE	<	TAPA-PÓ DO CILINDRO DE RODA	1967/1971		TA-0349	
GALAXIE	<	REPARO DE VEDAÇÃO DA PINÇA 57,00mm	1969/1980		C-1501	
GALAXIE	->	REPARO DO CILINDRO DE RODA 23,81mm	1967/1971		C-1405	
GALAXIE	->	REPARO DO CILINDRO DE RODA 22,22mm	1971/1982		C-1407	
GALAXIE	->	COPO DO CILINDRO DE RODA 23,81mm	1967/1971		CO-1311	
GALAXIE	->	COPO DO CILINDRO DE RODA 22,22mm	1971/1982		CO-1315	
GALAXIE	->	TAPA-PÓ DO CILINDRO DE RODA	1967/1982		TA-0314	
JEEP		CILINDRO MESTRE SIMPLES 25,40mm	1960/1981		C-2036	
JEEP		REPARO DO CILINDRO MESTRE SIMPLES 25,40mm	1960/1981		C-1013	
JEEP	<	CILINDRO DE RODA ESQUERDA 28,57mm	1960/1983		C-3378	
JEEP	<	CILINDRO DE RODA DIREITA 28,57mm	1960/1983		C-3379	
JEEP	<	REPARO DO CILINDRO DE RODA 25,40mm	1942/1959		C-1435	
JEEP	<	REPARO DO CILINDRO DE RODA 28,57mm	1960/1983		C-1438	
JEEP	<	COPO DO CILINDRO DE RODA 25,40mm	1942/1959		CO-1307	
JEEP	<	COPO DO CILINDRO DE RODA 28,57mm	1960/1983		CO-1309	
JEEP	<	TAPA-PÓ DO CILINDRO DE RODA	1942/1959		TA-0320	
JEEP	<	TAPA-PÓ DO CILINDRO DE RODA	1960/1983		TA-0316	
JEEP	->	CILINDRO DE RODA ESQUERDA 25,40mm	1960/1983		C-3380	
JEEP	->	CILINDRO DE RODA DIREITA 25,40mm	1960/1983		C-3381	
JEEP	->	REPARO DO CILINDRO DE RODA 25,40mm	1960/1983		C-1435	
JEEP	->	COPO DO CILINDRO DE RODA 25,40mm	1960/1983		CO-1307	
JEEP	->	TAPA-PÓ DO CILINDRO DE RODA	1960/1983		TA-0320	
KA		CILINDRO MESTRE DE EMBREAGEM 19,05mm	1997/1998		C-2645	

BUSCA POR VEÍCULOS

Tabela de Conversão	Polegadas	9/16"	5/8"	11/16"	7/10"	3/4"	13/16"	7/8"	15/16"	1"	1 1/16"	1 1/8"	1 1/4"	1 3/8"	1 1/2"	1 5/8"	1 3/4"	1 27/32"	2"
	Milímetros	14,28mm	15,87mm	17,46mm	17,78mm	19,05mm	20,63mm	22,22mm	23,81mm	25,40mm	26,98mm	28,57mm	31,75mm	34,92mm	38,10mm	41,27mm	44,45mm	46,83mm	50,80mm



VEÍCULO		DESCRIÇÃO	ANOS	OBSERVAÇÃO	REF.	IMAGEM
<b>FORD</b>						
KA		CILINDRO MESTRE DE EMBREAGEM 19,05mm	1999/...		C-2643	
KA		CIL. ATUADOR CONCÊNTRICO DE EMBREAGEM	1997/2007	COM ADAPTADOR	C-2711	
KA		CIL. ATUADOR CONCÊNTRICO DE EMBREAGEM	2008/...	SEM ADAPTADOR	C-2711	
KA		SERVO FREIO 200mm	1997/2007	MOTOR 1.0/1.3	C-5638	
KA		SERVO FREIO 200mm	2001/2007	MOTOR 1.6	C-5671	
KA		SERVO FREIO 230mm	2008/...		C-5635	
KA		CILINDRO MESTRE DUPLA 20,63mm	1997/1999	MOTOR 1.0/1.3 SIST. VARGA	C-2081	
KA		CILINDRO MESTRE DUPLA 20,63mm	2000/2007	MOTOR 1.0	C-2093	
KA		CILINDRO MESTRE DUPLA 22,22mm	2008/...	MOTOR 1.0	C-2061	
KA		CILINDRO MESTRE DUPLA 23,81mm	2008/...	MOTOR 1.6	C-2091	
KA		REPARO DO CILINDRO MESTRE DUPLA 20,63mm	1997/2007	MOTOR 1.0/1.3	C-1150	
KA		REPARO DO CILINDRO MESTRE DUPLA 22,22mm	2008/...	MOTOR 1.0	C-1145	
KA		REPARO DO CILINDRO MESTRE DUPLA 23,81mm	2008/...	MOTOR 1.6	C-1146	
KA		VEDANTE DO CILINDRO MESTRE	1998/...		VE-0204	
KA	<-	REPARO DE VEDAÇÃO DA PINÇA 48,00mm	1997/2007		C-1443	
KA	<-	REPARO DE VEDAÇÃO DA PINÇA 54,00mm	2008/...	MOTOR 1.6	C-1419	
KA	<-	REPARO DE VEDAÇÃO DA PINÇA 48,00mm	2008/...	MOTOR 1.0	C-1443	

Tabela de Conversão	Polegadas	9/16"	5/8"	11/16"	7/10"	3/4"	13/16"	7/8"	15/16"	1"	1 1/16"	1 1/8"	1 1/4"	1 3/8"	1 1/2"	1 5/8"	1 3/4"	1 27/32"	2"
	Milímetros	14,28mm	15,87mm	17,46mm	17,78mm	19,05mm	20,63mm	22,22mm	23,81mm	25,40mm	26,98mm	28,57mm	31,75mm	34,92mm	38,10mm	41,27mm	44,45mm	46,83mm	50,80mm

VEÍCULO		DESCRIÇÃO	ANOS	OBSERVAÇÃO	REF.	IMAGEM
<b>FORD</b>						
KA	->	CILINDRO DE RODA 17,78mm	1997/...	MOTOR 1.0/1.3	C-3439	
KA	->	CILINDRO DE RODA 19,05mm	2001/...	MOTOR 1.6	C-3412	
KA	->	REPARO DO CILINDRO DE RODA 17,78mm	1997/...	MOTOR 1.0/1.3	C-1566	
KA	->	REPARO DO CILINDRO DE RODA 19,05mm	2001/...	MOTOR 1.6	C-1481	
KA	->	GAXETA DO CILINDRO DE RODA 17,78mm	1997/...	MOTOR 1.0/1.3	GA-0301	
KA	->	GAXETA DO CILINDRO DE RODA 19,05mm	2001/...	MOTOR 1.6	GA-0307	
KA	->	TAPA-PÓ DO CILINDRO DE RODA	1997/...		TA-0312	
MAVERICK		VÁLVULA DE RETENÇÃO DE VÁCUO	1977/1979		C-1755	
MAVERICK		REPARO DO CILINDRO MESTRE SIMPLES 22,22mm	1973/1976		C-1093	
MAVERICK		REPARO DO CILINDRO MESTRE DUPLO 22,22mm	1977/1979	S/SERVO	C-1094	
MAVERICK		VEDANTE DO CILINDRO MESTRE	1977/1979	C/SERVO	VE-0201	
MAVERICK	<-	REPARO DE VEDAÇÃO DA PINÇA 66,00mm	1973/1976		C-1503	
MAVERICK	<-	REPARO DE VEDAÇÃO DA PINÇA 57,00mm	1977/1979		C-1501	
MAVERICK	->	COPO DO CILINDRO DE RODA 23,81mm	1973/1979		CO-1311	
MAVERICK	->	TAPA-PÓ DO CILINDRO DE RODA	1973/1976		TA-0314	
MAVERICK	->	TAPA-PÓ DO CILINDRO DE RODA	1977/1979		TA-0310	
MONDEO	<-	REPARO DE VEDAÇÃO DA PINÇA 60,00mm	1994/2001		C-1545	
MONDEO	->	CILINDRO DE RODA 22,22mm	1994/1996	C/ FREIO 8"	C-3518	
MONDEO	->	CILINDRO DE RODA 20,63mm	1994/2001	C/ FREIO 9"	C-3489	
MONDEO	->	REPARO DO CILINDRO DE RODA 22,22mm	1994/1996	C/ FREIO 8"	C-1582	
MONDEO	->	REPARO DO CILINDRO DE RODA 20,63mm	1994/2001	C/ FREIO 9"	C-1578	
MONDEO	->	GAXETA DO CILINDRO DE RODA 22,22mm	1994/1996	C/ FREIO 8"	GA-0207	
MONDEO	->	GAXETA DO CILINDRO DE RODA 20,63mm	1994/2001	C/ FREIO 9"	GA-0206	
MONDEO	->	TAPA-PÓ DO CILINDRO DE RODA	1994/2001		TA-0312	
MONDEO SW	<-	REPARO DE VEDAÇÃO DA PINÇA 60,00mm	1994/2001		C-1545	
MONDEO SW	->	CILINDRO DE RODA 22,22mm	1994/2001		C-3470	
MONDEO SW	->	REPARO DO CILINDRO DE RODA 22,22mm	1994/2001		C-1582	
MONDEO SW	->	GAXETA DO CILINDRO DE RODA 22,22mm	1994/2001		GA-0207	
MONDEO SW	->	TAPA-PÓ DO CILINDRO DE RODA	1994/2001		TA-0312	
PAMPA		SERVO FREIO 200mm	1982/1997		C-5601	









BUSCA POR VEÍCULOS

Tabela de Conversão	Polegadas	9/16"	5/8"	11/16"	7/10"	3/4"	13/16"	7/8"	15/16"	1"	1 1/16"	1 1/8"	1 1/4"	1 3/8"	1 1/2"	1 5/8"	1 3/4"	1 27/32"	2"
	Milímetros	14,28mm	15,87mm	17,46mm	17,78mm	19,05mm	20,63mm	22,22mm	23,81mm	25,40mm	26,98mm	28,57mm	31,75mm	34,92mm	38,10mm	41,27mm	44,45mm	46,83mm	50,80mm



VEÍCULO		DESCRIÇÃO	ANOS	OBSERVAÇÃO	REF.	IMAGEM
<b>FORD</b>						
PAMPA		VÁLVULA DE RETENÇÃO DE VÁCUO BRANCA	1982/1997	P/ SERVO VARGA SM180	C-1750	
PAMPA		VÁLVULA DE RETENÇÃO DE VÁCUO	1982/1997		C-1753	
PAMPA		CILINDRO MESTRE DUPL0 22,22mm	1982/1997		C-2002	
PAMPA		REPARO DO CILINDRO MESTRE DUPL0 22,22mm	1982/1997		C-1019	
PAMPA		RESERVATÓRIO C/ TAMP A E AVISO DE NÍVEL	1982/1997		C-0102	
PAMPA		VEDANTE DO CILINDRO MESTRE	1982/1997		VE-0201	
PAMPA	<-	REPARO DE VEDAÇÃO DA PINÇA 48,00mm	1982/1983	SIST. BENDIX COIFA C/ ENCAIXE INTERNO	C-1421	
PAMPA	<-	REPARO DE VEDAÇÃO DA PINÇA 48,00mm	1982/1983	SIST. BENDIX COIFA C/ ENCAIXE EXTERNO	C-1479	
PAMPA	<-	REPARO DE VEDAÇÃO DA PINÇA 48,00mm	1983/1997	SIST. VARGA	C-1413	
PAMPA	<-	TAPA PÓ DO PINO DE GUIA	1983/1997	SIST. VARGA	TA-0322	
PAMPA	->	CILINDRO DE RODA 19,05mm	1982/1997	C/ TRAÇÃO 4X2	C-3368	
PAMPA	->	CILINDRO DE RODA ESQUERDA 20,63mm	1983/1995	C/ TRAÇÃO 4X4	C-3458	
PAMPA	->	CILINDRO DE RODA DIREITA 20,63mm	1983/1995	C/ TRAÇÃO 4X4	C-3459	
PAMPA	->	REPARO DO CILINDRO DE RODA 19,05mm	1982/1997	C/ TRAÇÃO 4X2	C-1481	
PAMPA	->	REPARO DO CILINDRO DE RODA 20,63mm	1983/1995	C/ TRAÇÃO 4X4	C-1510	
PAMPA	->	GAXETA DO CILINDRO DE RODA 19,05mm	1982/1997	C/ TRAÇÃO 4X2	GA-0307	
PAMPA	->	COPO DO CILINDRO DE RODA 20,63mm	1983/1995	C/ TRAÇÃO 4X4	CO-1317	
PAMPA	->	TAPA-PÓ DO CILINDRO DE RODA	1982/1997	C/ TRAÇÃO 4X2	TA-0312	
PAMPA	->	TAPA-PÓ DO CILINDRO DE RODA	1983/1995	C/ TRAÇÃO 4X4	TA-0310	
RANGER		CILINDRO MESTRE DE EMBREAGEM 15,87mm	1995/2012		C-2649	
RANGER		CIL. ATUADOR CONCÊNTRICO DE EMBREAGEM	1994/2012		C-2702	
RANGER		CILINDRO MESTRE DUPL0 26,98mm C / RESERV.	1995/1997	MOTOR 6 CIL.	C-2132	
RANGER	<-	REPARO DE VEDAÇÃO DA PINÇA 46,00mm	1995/2012		C-1592	
RANGER	->	CILINDRO DE RODA 20,63mm	1998/2001	C/ FREIO 10"	C-3504	

Tabela de Conversão	Polegadas	9/16"	5/8"	11/16"	7/10"	3/4"	13/16"	7/8"	15/16"	1"	1 1/16"	1 1/8"	1 1/4"	1 3/8"	1 1/2"	1 5/8"	1 3/4"	1 27/32"	2"
	Milímetros	14,28mm	15,87mm	17,46mm	17,78mm	19,05mm	20,63mm	22,22mm	23,81mm	25,40mm	26,98mm	28,57mm	31,75mm	34,92mm	38,10mm	41,27mm	44,45mm	46,83mm	50,80mm

VEÍCULO		DESCRIÇÃO	ANOS	OBSERVAÇÃO	REF.	IMAGEM
<b>FORD</b>						
RANGER	->	CILINDRO DE RODA 20,63mm	1998/2005	C/ FREIO 11"	C-3497	
RANGER	->	CILINDRO DE RODA ESQUERDA 20,63mm	2005/2012		C-3466	
RANGER	->	CILINDRO DE RODA DIREITA 20,63mm	2005/2012		C-3467	
RANGER	->	REPARO DO CILINDRO DE RODA 20,63mm	1998/2001	C/ FREIO 10"	C-1410	
RANGER	->	REPARO DO CILINDRO DE RODA 20,63mm	1998/2012	C/ FREIO 11"	C-1581	
RANGER	->	COPO DO CILINDRO DE RODA 20,63mm	1994/1994		CO-1317	
RANGER	->	COPO DO CILINDRO DE RODA 20,63mm	1995/1997	C/ FREIO 10"	CO-1317	
RANGER	->	COPO DO CILINDRO DE RODA 20,63mm	1998/2012		CO-1317	
RANGER	->	TAPA-PÓ DO CILINDRO DE RODA	1998/2012	C/ FREIO 11"	TA-0314	
ROYALE		SERVO FREIO 230mm	1992/1996	SIST. VARGA E BOSCH S/ABS	C-5608	
ROYALE		SERVO FREIO 230mm	1992/1996	C/ABS	C-5652	
ROYALE		VÁLVULA DE RETENÇÃO DE VÁCUO	1992/1996		C-1753	
ROYALE		CILINDRO MESTRE DUPLA 20,63mm	1992/1994	S/ABS	C-2066	
ROYALE		CILINDRO MESTRE DUPLA 22,22mm	1992/1996	C/ABS	C-2099	
ROYALE		CILINDRO MESTRE DUPLA 22,22mm	1995/1996	SIST. VARGA E BOSCH S/ABS	C-2060	
ROYALE		REPARO DO CILINDRO MESTRE DUPLA 20,63mm	1992/1994	S/ABS	C-1055	
ROYALE		REPARO DO CILINDRO MESTRE DUPLA 22,22mm	1992/1996	C/ABS	C-1131	
ROYALE		REPARO DO CILINDRO MESTRE DUPLA 22,22mm	1995/1996	S/ABS	C-1137	
ROYALE		REPARO DO CILINDRO MESTRE DUPLA 22,22mm	1995/1996	P/ CILINDRO BOSCH S/ABS	C-1144	
ROYALE		RESERVATÓRIO C/ TAMPÃO E AVISO DE NÍVEL	1992/1996	S/ABS	C-0107	
ROYALE		VEDANTE DO CILINDRO MESTRE	1992/1996	S/ABS	VE-0201	
ROYALE		VEDANTE DO CILINDRO MESTRE	1992/1996	C/ABS	VE-0208	
ROYALE	<-	REPARO DE VEDAÇÃO DA PINÇA 48,00mm	1992/1994		C-1443	
ROYALE	<-	REPARO DE VEDAÇÃO DA PINÇA 54,00mm	1995/1996	SIST. ATE	C-1419	
ROYALE	<-	REPARO DE VEDAÇÃO DA PINÇA 54,00mm	1995/1996	SIST. VARGA	C-1568	
ROYALE	<-	TAPA PÓ DO PINO DE GUIA	1995/1996	SIST. VARGA	TA-0322	

BUSCA POR VEÍCULOS

Tabela de Conversão	Polegadas	9/16"	5/8"	11/16"	7/10"	3/4"	13/16"	7/8"	15/16"	1"	1 1/16"	1 1/8"	1 1/4"	1 3/8"	1 1/2"	1 5/8"	1 3/4"	1 27/32"	2"
	Milímetros	14,28mm	15,87mm	17,46mm	17,78mm	19,05mm	20,63mm	22,22mm	23,81mm	25,40mm	26,98mm	28,57mm	31,75mm	34,92mm	38,10mm	41,27mm	44,45mm	46,83mm	50,80mm

VEÍCULO		DESCRIÇÃO	ANOS	OBSERVAÇÃO	REF.	IMAGEM
<b>FORD</b>						
ROYALE	->	CILINDRO DE RODA 17,46mm	1992/1996		C-3356	
ROYALE	->	REPARO DO CILINDRO DE RODA 17,46mm	1992/1996		C-1446	
ROYALE	->	GAXETA DO CILINDRO DE RODA 17,46mm	1992/1996		GA-0309	
ROYALE	->	TAPA-PÓ DO CILINDRO DE RODA	1992/1996		TA-0338	
RURAL		CILINDRO MESTRE SIMPLES 25,40mm	1960/1977		C-2036	
RURAL		REPARO DO CILINDRO MESTRE SIMPLES 25,40mm	1960/1977		C-1013	
RURAL	<-	CILINDRO DE RODA ESQUERDA 28,57mm	1960/1977		C-3378	
RURAL	<-	CILINDRO DE RODA DIREITA 28,57mm	1960/1977		C-3379	
RURAL	<-	REPARO DO CILINDRO DE RODA 28,57mm	1960/1977		C-1438	
RURAL	<-	COPO DO CILINDRO DE RODA 28,57mm	1960/1977		CO-1309	
RURAL	<-	TAPA-PÓ DO CILINDRO DE RODA	1960/1977		TA-0316	
RURAL	->	CILINDRO DE RODA ESQUERDA 25,40mm	1960/1977		C-3380	
RURAL	->	CILINDRO DE RODA DIREITA 25,40mm	1960/1977		C-3381	
RURAL	->	REPARO DO CILINDRO DE RODA 25,40mm	1960/1977		C-1435	
RURAL	->	COPO DO CILINDRO DE RODA 25,40mm	1960/1977		CO-1307	
RURAL	->	TAPA-PÓ DO CILINDRO DE RODA	1960/1977		TA-0320	
VERONA		SERVO FREIO 200mm	1990/1992		C-5603	
VERONA		SERVO FREIO 230mm	1994/1996	SIST. VARGA	C-5623	
VERONA		SERVO FREIO 230mm	1994/1996	SIST. BOSCH	C-5624	

Tabela de Conversão	Polegadas	9/16"	5/8"	11/16"	7/10"	3/4"	13/16"	7/8"	15/16"	1"	1 1/16"	1 1/8"	1 1/4"	1 3/8"	1 1/2"	1 5/8"	1 3/4"	1 7/8"	2"
	Milímetros	14,28mm	15,87mm	17,46mm	17,78mm	19,05mm	20,63mm	22,22mm	23,81mm	25,40mm	26,98mm	28,57mm	31,75mm	34,92mm	38,10mm	41,27mm	44,45mm	46,83mm	50,80mm

VEÍCULO		DESCRIÇÃO	ANOS	OBSERVAÇÃO	REF.	IMAGEM
<b>FORD</b>						
VERONA		CILINDRO MESTRE DUPLO 22,00mm	1990/1992		C-2008	
VERONA		CILINDRO MESTRE DUPLO 23,81mm	1994/1996	SIST. VARGA	C-2038	
VERONA		CILINDRO MESTRE DUPLO 23,81mm	1994/1996	SIST. BOSCH	C-2051	
VERONA		REPARO DO CILINDRO MESTRE DUPLO 22,00mm	1990/1992		C-1012	
VERONA		REPARO DO CILINDRO MESTRE DUPLO 23,81mm	1994/1996	SIST. VARGA	C-1127	
VERONA		REPARO DO CILINDRO MESTRE DUPLO 23,81mm	1994/1996	SIST. BOSCH	C-1128	
VERONA		VEDANTE DO CILINDRO MESTRE	1990/1996		VE-0204	
VERONA	<-	REPARO DE VEDAÇÃO DA PINÇA 54,00mm	1990/1996	SIST. ATE	C-1419	
VERONA	<-	REPARO DE VEDAÇÃO DA PINÇA 54,00mm	1994/1996	SIST. BOSCH	C-1575	
VERONA	->	CILINDRO DE RODA 17,78mm	1990/1992		C-3439	
VERONA	->	CILINDRO DE RODA 19,05mm	1994/1996	SIST. VARGA	C-3412	
VERONA	->	CILINDRO DE RODA ESQUERDA 19,05mm	1994/1996	SIST. BOSCH	C-3435	
VERONA	->	CILINDRO DE RODA DIREITA 19,05mm	1994/1996	SIST. BOSCH	C-3436	
VERONA	->	REPARO DO CILINDRO DE RODA 17,78mm	1990/1992	P/ CIL. VARGA RCCR 0094.5	C-1420	
VERONA	->	REPARO DO CILINDRO DE RODA 17,78mm	1990/1992		C-1566	
VERONA	->	REPARO DO CILINDRO DE RODA 19,05mm	1994/1996	SIST. VARGA	C-1481	
VERONA	->	REPARO DO CILINDRO DE RODA 19,05mm	1994/1996	SIST. BOSCH	C-1554	
VERONA	->	GAXETA DO CILINDRO DE RODA 17,78mm	1990/1992		GA-0301	
VERONA	->	COPO DO CILINDRO DE RODA 19,05mm	1994/1996	SIST. BOSCH	CO-1312	
VERONA	->	GAXETA DO CILINDRO DE RODA 19,05mm	1994/1996	SIST. VARGA	GA-0307	
VERONA	->	TAPA-PÓ DO CILINDRO DE RODA	1990/1992		TA-0312	
VERONA	->	TAPA-PÓ DO CILINDRO DE RODA	1990/1992	P/ CIL. VARGA RCCR 0094.5	TA-0317	
VERONA	->	TAPA-PÓ DO CILINDRO DE RODA	1994/1996	SIST. VARGA	TA-0312	
VERONA	->	TAPA-PÓ DO CILINDRO DE RODA	1994/1996	SIST. BOSCH	TA-0321	

BUSCA POR VEÍCULOS

Tabela de Conversão	Polegadas	9/16"	5/8"	11/16"	7/10"	3/4"	13/16"	7/8"	15/16"	1"	1 1/16"	1 1/8"	1 1/4"	1 3/8"	1 1/2"	1 5/8"	1 3/4"	1 27/32"	2"
	Milímetros	14,28mm	15,87mm	17,46mm	17,78mm	19,05mm	20,63mm	22,22mm	23,81mm	25,40mm	26,98mm	28,57mm	31,75mm	34,92mm	38,10mm	41,27mm	44,45mm	46,83mm	50,80mm

VEÍCULO		DESCRIÇÃO	ANOS	OBSERVAÇÃO	REF.	IMAGEM
<b>FORD</b>						
VERSAILLES		SERVO FREIO 230mm	1991/1996	SIST. VARGA E BOSCH S/ABS	C-5608	
VERSAILLES		SERVO FREIO 230mm	1992/1996	C/ABS	C-5652	
VERSAILLES		VÁLVULA DE RETENÇÃO DE VÁCUO	1991/1994		C-1753	
VERSAILLES		CILINDRO MESTRE DUPL0 20,63mm	1991/1994	SIST. VARGA E BOSCH S/ABS	C-2015	
VERSAILLES		CILINDRO MESTRE DUPL0 22,22mm	1992/1996	C/ABS	C-2099	
VERSAILLES		CILINDRO MESTRE DUPL0 22,22mm	1995/1996	SIST. VARGA E BOSCH S/ABS	C-2060	
VERSAILLES		REPARO DO CILINDRO MESTRE DUPL0 20,63mm	1991/1994	S/ABS	C-1027	
VERSAILLES		REPARO DO CILINDRO MESTRE DUPL0 22,22mm	1992/1996	C/ABS	C-1131	
VERSAILLES		REPARO DO CILINDRO MESTRE DUPL0 22,22mm	1995/1996	S/ABS	C-1137	
VERSAILLES		REPARO DO CILINDRO MESTRE DUPL0 22,22mm	1995/1996	P/ CILINDRO BOSCH S/ABS	C-1144	
VERSAILLES		RESERVATÓRIO C/ TAMP A E AVISO DE NÍVEL	1991/1996	S/ABS	C-0107	
VERSAILLES		VEDANTE DO CILINDRO MESTRE	1991/1996	S/ABS	VE-0201	
VERSAILLES		VEDANTE DO CILINDRO MESTRE	1992/1996	C/ABS	VE-0208	
VERSAILLES	<-	REPARO DE VEDAÇÃO DA PINÇA 48,00mm	1991/1994		C-1443	
VERSAILLES	<-	REPARO DE VEDAÇÃO DA PINÇA 54,00mm	1995/1996	SIST. ATE	C-1419	
VERSAILLES	<-	REPARO DE VEDAÇÃO DA PINÇA 54,00mm	1995/1996	SIST. VARGA	C-1568	
VERSAILLES	<-	TAPA PÓ DO PINO DE GUIA	1995/1996	SIST. VARGA	TA-0322	
VERSAILLES	->	CILINDRO DE RODA 14,28mm	1991/1994		C-3350	
VERSAILLES	->	CILINDRO DE RODA 17,46mm	1991/1994	C/ CÂMBIO AUTOMÁTICO	C-3356	
VERSAILLES	->	CILINDRO DE RODA 17,46mm	1995/1996		C-3356	
VERSAILLES	->	REPARO DO CILINDRO DE RODA 17,46mm	1991/1994	C/ CÂMBIO AUTOMÁTICO	C-1446	
VERSAILLES	->	REPARO DO CILINDRO DE RODA 14,28mm	1991/1994		C-1494	
VERSAILLES	->	REPARO DO CILINDRO DE RODA 17,46mm	1995/1996		C-1446	
VERSAILLES	->	GAXETA DO CILINDRO DE RODA 17,46mm	1991/1994	C/ CÂMBIO AUTOMÁTICO	GA-0309	
VERSAILLES	->	GAXETA DO CILINDRO DE RODA 14,28mm	1991/1994		GA-0311	
VERSAILLES	->	GAXETA DO CILINDRO DE RODA 17,46mm	1995/1996		GA-0309	
VERSAILLES	->	TAPA-PÓ DO CILINDRO DE RODA	1991/1996		TA-0338	

Tabela de Conversão	Polegadas	9/16"	5/8"	11/16"	7/10"	3/4"	13/16"	7/8"	15/16"	1"	1 1/16"	1 1/8"	1 1/4"	1 3/8"	1 1/2"	1 5/8"	1 3/4"	1 27/32"	2"
	Milímetros	14,28mm	15,87mm	17,46mm	17,78mm	19,05mm	20,63mm	22,22mm	23,81mm	25,40mm	26,98mm	28,57mm	31,75mm	34,92mm	38,10mm	41,27mm	44,45mm	46,83mm	50,80mm

VEÍCULO		DESCRIÇÃO	ANOS	OBSERVAÇÃO	REF.	IMAGEM
<b>FORD - CAMINHÕES</b>						
B-1618/1621		CILINDRO MESTRE DE EMBREAGEM 22,22mm	1993/1996		C-2605	
B-1618/1621		CILINDRO AUXILIAR DE EMBREAGEM 22,22mm	1993/1996		C-2613	
B-1618/1621		REPARO DO CIL. MESTRE DE EMBREAGEM 22,22mm	1993/1996		C-1631	
B-1618/1621		REPARO DO CIL. AUXILIAR DE EMBREAGEM 22,22mm	1993/1996		C-1630	
CARGO		CILINDRO MESTRE DE EMBREAGEM 22,22mm	1985/...		C-2604	
CARGO		CILINDRO AUXILIAR DE EMBREAGEM 22,22mm	1985/...		C-2613	
CARGO		REPARO DO CIL. MESTRE DE EMBREAGEM 22,22mm	1985/...		C-1623	
CARGO		REPARO DO CIL. AUXILIAR DE EMBREAGEM 22,22mm	1985/...		C-1630	
F-350		REPARO DO CIL. MESTRE DE EMBREAGEM 26,98mm	1962/1971		C-1601	
F-350		REPARO DO CIL. AUXILIAR DE EMBREAGEM 25,40mm	1962/1971		C-1602	
F-350		REPARO DO HYDROVAC 9 1/2"	1972/1975		C-1213	
F-350		REPARO DO CILINDRO MESTRE SIMPLES 31,75mm	1962/1974		C-1054	
F-350		REPARO DO CILINDRO MESTRE SIMPLES 31,75mm	1974/1975		C-1101	
F-350	<	CILINDRO DE RODA ESQUERDA 28,57mm	1972/1975		C-3307	
F-350	<	CILINDRO DE RODA DIREITA 28,57mm	1972/1975		C-3308	
F-350	<	REPARO DO CILINDRO DE RODA 28,57mm	1956/1971		C-1408	
F-350	<	REPARO DO CILINDRO DE RODA 28,57mm	1972/1975		C-1422	
F-350	<	COPO DO CILINDRO DE RODA 28,57mm	1956/1975		CO-1309	
F-350	<	TAPA-PÓ DO CILINDRO DE RODA	1956/1971		TA-0314	
F-350	<	TAPA-PÓ DO CILINDRO DE RODA	1972/1975		TA-0349	
F-350	<	REPARO DE VEDAÇÃO DA PINÇA 54,00mm	1999/2012		C-1599	
F-350	>	CILINDRO DE RODA ESQUERDA 31,75mm	1971/1975		C-3311	
F-350	>	CILINDRO DE RODA DIREITA 31,75mm	1971/1975		C-3312	

BUSCA POR VEÍCULOS

Tabela de Conversão	Polegadas	9/16"	5/8"	11/16"	7/10"	3/4"	13/16"	7/8"	15/16"	1"	1 1/16"	1 1/8"	1 1/4"	1 3/8"	1 1/2"	1 5/8"	1 3/4"	1 27/32"	2"
	Milímetros	14,28mm	15,87mm	17,46mm	17,78mm	19,05mm	20,63mm	22,22mm	23,81mm	25,40mm	26,98mm	28,57mm	31,75mm	34,92mm	38,10mm	41,27mm	44,45mm	46,83mm	50,80mm

VEÍCULO		DESCRIÇÃO	ANOS	OBSERVAÇÃO	REF.	IMAGEM
<b>FORD - CAMINHÕES</b>						
F-350	->	CILINDRO DE RODA ESQUERDA 28,57mm	1999/2012		C-3494	
F-350	->	CILINDRO DE RODA DIREITA 28,57mm	1999/2012		C-3495	
F-350	->	REPARO DO CILINDRO DE RODA 31,75mm	1956/1975		C-1412	
F-350	->	REPARO DO CILINDRO DE RODA 28,57mm	1999/2012		C-1422	
F-350	->	COPO DO CILINDRO DE RODA 31,75mm	1956/1975		CO-1300	
F-350	->	COPO DO CILINDRO DE RODA 28,57mm	1999/2012		CO-1309	
F-350	->	TAPA-PÓ DO CILINDRO DE RODA	1956/1975		TA-0350	
F-350	->	TAPA-PÓ DO CILINDRO DE RODA	1999/2012		TA-0349	
F-350	->	REPARO DE VEDAÇÃO DA PINÇA 54,00mm	1999/2012		C-1599	
F-400		REPARO DO HYDROVAC 9 1/2"	1975/1977		C-1213	
F-400		REPARO DO CILINDRO MESTRE SIMPLES 31,75mm	1975/1977		C-1101	
F-400	<-	CILINDRO DE RODA ESQUERDA 28,57mm	1975/1977		C-3307	
F-400	<-	CILINDRO DE RODA DIREITA 28,57mm	1975/1977		C-3308	
F-400	<-	REPARO DO CILINDRO DE RODA 28,57mm	1975/1977		C-1422	
F-400	<-	COPO DO CILINDRO DE RODA 28,57mm	1975/1977		CO-1309	
F-400	<-	TAPA-PÓ DO CILINDRO DE RODA	1975/1977		TA-0349	
F-400	->	CILINDRO DE RODA ESQUERDA 31,75mm	1975/1977		C-3313	
F-400	->	CILINDRO DE RODA DIREITA 31,75mm	1975/1977		C-3314	
F-400	->	REPARO DO CILINDRO DE RODA 31,75mm	1975/1977		C-1412	
F-400	->	COPO DO CILINDRO DE RODA 31,75mm	1975/1977		CO-1300	
F-400	->	TAPA-PÓ DO CILINDRO DE RODA	1975/1977		TA-0350	
F-600		REPARO DO CIL. MESTRE DE EMBREAGEM 26,98mm	1962/1971		C-1601	
F-600		REPARO DO CIL. AUXILIAR DE EMBREAGEM 25,40mm	1962/1971		C-1602	
F-600		REPARO DO HYDROVAC 9 1/2"	1960/1980		C-1213	
F-600		REPARO DO CILINDRO MESTRE SIMPLES 38,10mm	1960/1980		C-1011	
F-600	<-	CILINDRO DE RODA ESQUERDA 28,57mm	1972/1980		C-3309	

Tabela de Conversão	Polegadas	9/16"	5/8"	11/16"	7/10"	3/4"	13/16"	7/8"	15/16"	1"	1 1/16"	1 1/8"	1 1/4"	1 3/8"	1 1/2"	1 5/8"	1 3/4"	1 27/32"	2"
	Milímetros	14,28mm	15,87mm	17,46mm	17,78mm	19,05mm	20,63mm	22,22mm	23,81mm	25,40mm	26,98mm	28,57mm	31,75mm	34,92mm	38,10mm	41,27mm	44,45mm	46,83mm	50,80mm

VEÍCULO		DESCRIÇÃO	ANOS	OBSERVAÇÃO	REF.	IMAGEM
<b>FORD - CAMINHÕES</b>						
F-600	<	CILINDRO DE RODA DIREITA 28,57mm	1972/1980		C-3310	
F-600	<	REPARO DO CILINDRO DE RODA 28,57mm	1972/1980		C-1422	
F-600	<	COPO DO CILINDRO DE RODA 25,40mm	1960/1971		CO-1307	
F-600	<	COPO DO CILINDRO DE RODA 28,57mm	1972/1980		CO-1309	
F-600	<	TAPA-PÓ DO CILINDRO DE RODA	1960/1971		TA-0314	
F-600	<	TAPA-PÓ DO CILINDRO DE RODA	1972/1980		TA-0349	
F-600	->	CILINDRO DE RODA ESQUERDA SUPERIOR 41,27mm	1960/1980	TERCEIRO EIXO	C-3315	
F-600	->	CILINDRO DE RODA DIREITA SUPERIOR 41,27mm	1960/1980	TERCEIRO EIXO	C-3316	
F-600	->	CILINDRO DE RODA ESQUERDA INFERIOR 41,27mm	1960/1980	TERCEIRO EIXO	C-3317	
F-600	->	CILINDRO DE RODA DIREITA INFERIOR 41,27mm	1960/1980	TERCEIRO EIXO	C-3318	
F-600	->	CILINDRO DE RODA ESQUERDA SUPERIOR 41,27mm	1974/1980		C-3315	
F-600	->	CILINDRO DE RODA DIREITA SUPERIOR 41,27mm	1974/1980		C-3316	
F-600	->	CILINDRO DE RODA ESQUERDA INFERIOR 41,27mm	1974/1980		C-3317	
F-600	->	CILINDRO DE RODA DIREITA INFERIOR 41,27mm	1974/1980		C-3318	
F-600	->	REPARO DO CILINDRO DE RODA 41,27mm	1956/1980		C-1485	
F-600	->	GAXETA DO CILINDRO DE RODA 41,27mm	1956/1980		GA-0300	
F-600	->	TAPA-PÓ DO CILINDRO DE RODA	1956/1980		TA-0323	









BUSCA POR VEÍCULOS

Tabela de Conversão	Polegadas	9/16"	5/8"	11/16"	7/10"	3/4"	13/16"	7/8"	15/16"	1"	1 1/16"	1 1/8"	1 1/4"	1 3/8"	1 1/2"	1 5/8"	1 3/4"	1 27/32"	2"
	Milímetros	14,28mm	15,87mm	17,46mm	17,78mm	19,05mm	20,63mm	22,22mm	23,81mm	25,40mm	26,98mm	28,57mm	31,75mm	34,92mm	38,10mm	41,27mm	44,45mm	46,83mm	50,80mm



VEÍCULO		DESCRIÇÃO	ANOS	OBSERVAÇÃO	REF.	IMAGEM
<b>FORD - CAMINHÕES</b>						
F-4000		CILINDRO MESTRE DE EMBREAGEM 22,22mm	1995/1998	MOTOR MWM 4.3 TURBO	C-2628	
F-4000		CILINDRO AUXILIAR DE EMBREAGEM 22,22mm	1995/1998	MOTOR MWM 4.3 TURBO	C-2613	
F-4000		REPARO DO CIL. MESTRE DE EMBREAGEM 22,22mm	1995/1998	MOTOR MWM 4.3 TURBO	C-1636	
F-4000		REPARO DO CIL. AUXILIAR DE EMBREAGEM 22,22mm	1995/1998	MOTOR MWM 4.3 TURBO	C-1630	
F-4000		VEDANTE DO CILINDRO MESTRE	1995/1998		VE-0204	
F-4000		REPARO DO HYDROVAC 9 1/2"	1975/1982		C-1213	
F-4000		REPARO DO HYDROVAC 9 1/2"	1983/1992		C-1209	
F-4000		CILINDRO MESTRE SIMPLES 38,10mm	1988/1992		C-2077	
F-4000		CILINDRO MESTRE DUPLA 28,57mm	1992/1998	SIST. BOSCH	C-2062	
F-4000		REPARO DO CILINDRO MESTRE SIMPLES 31,75mm	1975/1984		C-1101	
F-4000		REPARO DO CILINDRO MESTRE SIMPLES 38,10mm	1985/1992		C-1034	
F-4000		REPARO DO CILINDRO MESTRE DUPLA 28,57mm	1992/1998	SIST. BOSCH	C-1125	
F-4000		REPARO DO CILINDRO MESTRE DUPLA 31,75mm	1995/1998	SIST. VARGA	C-1157	
F-4000		RESERVATÓRIO C/ TAMPA E AVISO DE NÍVEL	1992/1998	SIST. BOSCH	C-0111	
F-4000		VEDANTE DO CILINDRO MESTRE	1988/1998	SIST. BOSCH	VE-0203	
F-4000	<	CILINDRO DE RODA ESQUERDA 28,57mm	1975/1984		C-3307	
F-4000	<	CILINDRO DE RODA DIREITA 28,57mm	1975/1984		C-3308	
F-4000	<	REPARO DO CILINDRO DE RODA 28,57mm	1975/1984		C-1422	
F-4000	<	COPO DO CILINDRO DE RODA 28,57mm	1975/1984		CO-1309	
F-4000	<	TAPA-PÓ DO CILINDRO DE RODA	1975/1984		TA-0349	
F-4000	<	REPARO DE VEDAÇÃO DA PINÇA 76,00mm	1985/1998		C-1528	
F-4000	<	REPARO DE VEDAÇÃO DA PINÇA 54,00mm	1999/2012		C-1599	
F-4000	>	CILINDRO DE RODA ESQUERDA 31,75mm	1975/1984		C-3313	
F-4000	>	CILINDRO DE RODA DIREITA 31,75mm	1975/1984		C-3314	

Tabela de Conversão	Polegadas	9/16"	5/8"	11/16"	7/10"	3/4"	13/16"	7/8"	15/16"	1"	1 1/16"	1 1/8"	1 1/4"	1 3/8"	1 1/2"	1 5/8"	1 3/4"	1 27/32"	2"
	Milímetros	14,28mm	15,87mm	17,46mm	17,78mm	19,05mm	20,63mm	22,22mm	23,81mm	25,40mm	26,98mm	28,57mm	31,75mm	34,92mm	38,10mm	41,27mm	44,45mm	46,83mm	50,80mm

VEÍCULO		DESCRIÇÃO	ANOS	OBSERVAÇÃO	REF.	IMAGEM
<b>FORD - CAMINHÕES</b>						
F-4000	->	CILINDRO DE RODA ESQUERDA 23,81mm	1985/1994		C-3305	
F-4000	->	CILINDRO DE RODA DIREITA 23,81mm	1985/1994		C-3306	
F-4000	->	CILINDRO DE RODA ESQUERDA 25,40mm	1995/1998		C-3337	
F-4000	->	CILINDRO DE RODA DIREITA 25,40mm	1995/1998		C-3338	
F-4000	->	REPARO DO CILINDRO DE RODA 31,75mm	1975/1984		C-1412	
F-4000	->	REPARO DO CILINDRO DE RODA 23,81mm	1985/1994		C-1405	
F-4000	->	REPARO DO CILINDRO DE RODA 25,40mm	1995/1998		C-1416	
F-4000	->	REPARO DO CILINDRO DE RODA 25,40mm	2002/2005		C-1416	
F-4000	->	REPARO DO CILINDRO DE RODA 31,75mm	2005/2012		C-1412	
F-4000	->	COPO DO CILINDRO DE RODA 31,75mm	1975/1984		CO-1300	
F-4000	->	COPO DO CILINDRO DE RODA 23,81mm	1985/1994		CO-1311	
F-4000	->	COPO DO CILINDRO DE RODA 25,40mm	1995/1998		CO-1307	
F-4000	->	TAPA-PÓ DO CILINDRO DE RODA	1975/1984		TA-0350	
F-4000	->	TAPA-PÓ DO CILINDRO DE RODA	1985/1998		TA-0314	
F-4000	->	REPARO DE VEDAÇÃO DA PINÇA 54,00mm	1999/2012		C-1599	
FB-4000		REPARO DO CIL. MESTRE DE EMBREAGEM 28,57mm	1982/1985		C-1610	
FB-4000		REPARO DO CIL. AUXILIAR DE EMBREAGEM 28,57mm	1982/1985		C-1611	
FB-4000		REPARO DO CILINDRO MESTRE SIMPLES 31,75mm	1982/1985		C-1023	
FB-4000	<-	REPARO DO CILINDRO DE RODA 34,92mm	1982/1985		C-1520	
FB-4000	<-	GAXETA DO CILINDRO DE RODA 34,92mm	1982/1985		GA-0318	
FB-4000	<-	TAPA-PÓ DO CILINDRO DE RODA	1982/1985		TA-0325	
F-7000		REPARO DO HYDROVAC 9 1/2"	1972/1980		C-1213	
F-7000		REPARO DO CILINDRO MESTRE SIMPLES 38,10mm	1972/1980		C-1011	
F-7000	<-	CILINDRO DE RODA ESQUERDA 28,57mm	1972/1980		C-3309	
F-7000	<-	CILINDRO DE RODA DIREITA 28,57mm	1972/1980		C-3310	
F-7000	<-	REPARO DO CILINDRO DE RODA 28,57mm	1972/1980		C-1422	
F-7000	<-	COPO DO CILINDRO DE RODA 28,57mm	1972/1980		CO-1309	
F-7000	<-	TAPA-PÓ DO CILINDRO DE RODA	1972/1980		TA-0349	
F-7000	->	CILINDRO DE RODA ESQUERDA SUPERIOR 41,27mm	1972/1980	TERCEIRO EIXO	C-3315	

BUSCA POR VEÍCULOS

Tabela de Conversão	Polegadas	9/16"	5/8"	11/16"	7/10"	3/4"	13/16"	7/8"	15/16"	1"	1 1/16"	1 1/8"	1 1/4"	1 3/8"	1 1/2"	1 5/8"	1 3/4"	1 27/32"	2"
	Milímetros	14,28mm	15,87mm	17,46mm	17,78mm	19,05mm	20,63mm	22,22mm	23,81mm	25,40mm	26,98mm	28,57mm	31,75mm	34,92mm	38,10mm	41,27mm	44,45mm	46,83mm	50,80mm

VEÍCULO		DESCRIÇÃO	ANOS	OBSERVAÇÃO	REF.	IMAGEM
<b>FORD - CAMINHÕES</b>						
F-7000	->	CILINDRO DE RODA DIREITA SUPERIOR 41,27mm	1972/1980	TERCEIRO EIXO	C-3316	
F-7000	->	CILINDRO DE RODA ESQUERDA INFERIOR 41,27mm	1972/1980	TERCEIRO EIXO	C-3317	
F-7000	->	CILINDRO DE RODA DIREITA INFERIOR 41,27mm	1972/1980	TERCEIRO EIXO	C-3318	
F-7000	->	CILINDRO DE RODA ESQUERDA SUPERIOR 41,27mm	1974/1980		C-3315	
F-7000	->	CILINDRO DE RODA DIREITA SUPERIOR 41,27mm	1974/1980		C-3316	
F-7000	->	CILINDRO DE RODA ESQUERDA INFERIOR 41,27mm	1974/1980		C-3317	
F-7000	->	CILINDRO DE RODA DIREITA INFERIOR 41,27mm	1974/1980		C-3318	
F-7000	->	REPARO DO CILINDRO DE RODA 41,27mm	1972/1980		C-1485	
F-7000	->	GAXETA DO CILINDRO DE RODA 41,27mm	1972/1980		GA-0300	
F-7000	->	TAPA-PÓ DO CILINDRO DE RODA	1972/1980		TA-0323	
F-11000		REPARO DO HYDROVAC 9 1/2"	1980/1985	ESCRAVO	C-1213	
F-11000		REPARO DO HYDROVAC 10"	1980/1986		C-1201	
F-11000		REPARO DO HYDROVAC 10"	1986/1992		C-1216	
F-11000		REPARO PARCIAL DO HYDROVAC 10"	1980/1986		C-1202	
F-11000		DIAFRAGMA DO HYDROVAC 10"	1980/1992		DI-0500	
F-11000		REPARO DO CILINDRO MESTRE SIMPLES 38,10mm	1980/1985		C-1011	
F-11000		REPARO DO CILINDRO MESTRE SIMPLES 38,10mm	1986/1992		C-1034	
F-11000	<-	CILINDRO DE RODA ESQUERDA 28,57mm	1980/1992		C-3309	
F-11000	<-	CILINDRO DE RODA DIREITA 28,57mm	1980/1992		C-3310	
F-11000	<-	REPARO DO CILINDRO DE RODA 28,57mm	1980/1992		C-1422	
F-11000	<-	COPO DO CILINDRO DE RODA 28,57mm	1980/1992		CO-1309	

Tabela de Conversão	Polegadas	9/16"	5/8"	11/16"	7/10"	3/4"	13/16"	7/8"	15/16"	1"	1 1/16"	1 1/8"	1 1/4"	1 3/8"	1 1/2"	1 5/8"	1 3/4"	1 27/32"	2"
	Milímetros	14,28mm	15,87mm	17,46mm	17,78mm	19,05mm	20,63mm	22,22mm	23,81mm	25,40mm	26,98mm	28,57mm	31,75mm	34,92mm	38,10mm	41,27mm	44,45mm	46,83mm	50,80mm

VEÍCULO		DESCRIÇÃO	ANOS	OBSERVAÇÃO	REF.	IMAGEM
<b>FORD - CAMINHÕES</b>						
F-11000	<	TAPA-PÓ DO CILINDRO DE RODA	1980/1992		TA-0349	
F-11000	->	CILINDRO DE RODA ESQUERDA SUPERIOR 41,27mm	1980/1992	TERCEIRO EIXO	C-3315	
F-11000	->	CILINDRO DE RODA ESQUERDA SUPERIOR 41,27mm	1980/1992		C-3315	
F-11000	->	CILINDRO DE RODA DIREITA SUPERIOR 41,27mm	1980/1992	TERCEIRO EIXO	C-3316	
F-11000	->	CILINDRO DE RODA DIREITA SUPERIOR 41,27mm	1980/1992		C-3316	
F-11000	->	CILINDRO DE RODA ESQUERDA INFERIOR 41,27mm	1980/1992	TERCEIRO EIXO	C-3317	
F-11000	->	CILINDRO DE RODA ESQUERDA INFERIOR 41,27mm	1980/1992		C-3317	
F-11000	->	CILINDRO DE RODA DIREITA INFERIOR 41,27mm	1980/1992	TERCEIRO EIXO	C-3318	
F-11000	->	CILINDRO DE RODA DIREITA INFERIOR 41,27mm	1980/1992		C-3318	
F-11000	->	REPARO DO CILINDRO DE RODA 41,27mm	1980/1992		C-1485	
F-11000	->	GAXETA DO CILINDRO DE RODA 41,27mm	1980/1992		GA-0300	
F-11000	->	TAPA-PÓ DO CILINDRO DE RODA	1980/1992		TA-0323	
F-12000		CILINDRO MESTRE DE EMBREAGEM 22,22mm	1996/1998		C-2605	
F-12000		CILINDRO MESTRE DE EMBREAGEM 18,20mm	1999/2005		C-2658	

BUSCA POR VEÍCULOS

Tabela de Conversão	Polegadas	9/16"	5/8"	11/16"	7/10"	3/4"	13/16"	7/8"	15/16"	1"	1 1/16"	1 1/8"	1 1/4"	1 3/8"	1 1/2"	1 5/8"	1 3/4"	1 27/32"	2"
	Milímetros	14,28mm	15,87mm	17,46mm	17,78mm	19,05mm	20,63mm	22,22mm	23,81mm	25,40mm	26,98mm	28,57mm	31,75mm	34,92mm	38,10mm	41,27mm	44,45mm	46,83mm	50,80mm











VEÍCULO		DESCRIÇÃO	ANOS	OBSERVAÇÃO	REF.	IMAGEM
<b>FORD - CAMINHÕES</b>						
F-12000		CILINDRO AUXILIAR DE EMBREAGEM 22,22mm	1996/1998		C-2613	
F-12000		REPARO DO CIL. MESTRE DE EMBREAGEM 22,22mm	1996/1998		C-1631	
F-12000		REPARO DO CIL. AUXILIAR DE EMBREAGEM 22,22mm	1996/1998		C-1630	
F-14000		CILINDRO MESTRE DE EMBREAGEM 22,22mm	1996/1998		C-2605	
F-14000		CILINDRO MESTRE DE EMBREAGEM 18,20mm	1999/2005		C-2658	
F-14000		CILINDRO AUXILIAR DE EMBREAGEM 22,22mm	1996/1998		C-2613	
F-14000		REPARO DO CIL. MESTRE DE EMBREAGEM 22,22mm	1996/1998		C-1631	
F-14000		REPARO DO CIL. AUXILIAR DE EMBREAGEM 22,22mm	1996/1998		C-1630	
F-16000		CILINDRO MESTRE DE EMBREAGEM 18,20mm	1999/2004		C-2658	
<b>GM - CHEVROLET</b>						
3100		REPARO DO CILINDRO MESTRE SIMPLES 25,40mm	1965/1967		C-1051	
3100	<	CILINDRO DE RODA ESQUERDA 28,57mm	1956/1963		C-3390	
3100	<	CILINDRO DE RODA DIREITA 28,57mm	1956/1963		C-3391	
3100	<	CILINDRO DE RODA ESQUERDA 28,57mm	1964/1967		C-3421	
3100	<	CILINDRO DE RODA DIREITA 28,57mm	1964/1967		C-3422	
3100	<	REPARO DO CILINDRO DE RODA 28,57mm	1956/1967		C-1422	
3100	<	COPO DO CILINDRO DE RODA 28,57mm	1956/1967		CO-1309	
3100	<	TAPA-PÓ DO CILINDRO DE RODA	1956/1967		TA-0349	
3100	>	CILINDRO DE RODA ESQUERDA 25,40mm	1956/1967		C-3392	

Tabela de Conversão	Polegadas	9/16"	5/8"	11/16"	7/10"	3/4"	13/16"	7/8"	15/16"	1"	1 1/16"	1 1/8"	1 1/4"	1 3/8"	1 1/2"	1 5/8"	1 3/4"	1 27/32"	2"
	Milímetros	14,28mm	15,87mm	17,46mm	17,78mm	19,05mm	20,63mm	22,22mm	23,81mm	25,40mm	26,98mm	28,57mm	31,75mm	34,92mm	38,10mm	41,27mm	44,45mm	46,83mm	50,80mm

VEÍCULO		DESCRIÇÃO	ANOS	OBSERVAÇÃO	REF.	IMAGEM
<b>GM - CHEVROLET</b>						
3100	->	CILINDRO DE RODA DIREITA 25,40mm	1956/1967		C-3393	
3100	->	REPARO DO CILINDRO DE RODA 25,40mm	1956/1967		C-1416	
3100	->	COPO DO CILINDRO DE RODA 25,40mm	1956/1967		CO-1307	
3100	->	TAPA-PÓ DO CILINDRO DE RODA	1956/1967		TA-0314	
A-10		SERVO FREIO 200mm	1979/1984		C-5618	
A-10		SERVO FREIO 200mm	1985/1988		C-5621	
A-10		VÁLVULA DE RETENÇÃO DE VÁCUO	1979/1988		C-1755	
A-10		CILINDRO MESTRE DUPLA 25,40mm C/ RESERV.	1979/1984		C-2052	
A-10		CILINDRO MESTRE DUPLA 25,40mm	1985/1988		C-2054	
A-10		CILINDRO MESTRE DUPLA 28,57mm	1989/1989		C-2044	
A-10		REPARO DO CILINDRO MESTRE DUPLA 25,40mm	1979/1988		C-1092	
A-10		REPARO DO CILINDRO MESTRE DUPLA 28,57mm	1989/1989		C-1114	
A-10		RESERVATÓRIO C/ TAMPAS	1985/1987		C-0105	
A-10		RESERVATÓRIO C/ TAMPAS E AVISO DE NÍVEL	1988/1989		C-0109	
A-10		VEDANTE DO CILINDRO MESTRE	1979/1989		VE-0203	
A-10	<-	REPARO DE VEDAÇÃO DA PINÇA 79,00mm	1985/1989	(2 RODAS)	C-1500	
A-10	->	CILINDRO DE RODA ESQUERDA 22,22mm	1985/1989		C-3444	
A-10	->	CILINDRO DE RODA DIREITA 22,22mm	1985/1989		C-3445	
A-10	->	REPARO DO CILINDRO DE RODA 22,22mm	1985/1989		C-1407	
A-10	->	COPO DO CILINDRO DE RODA 22,22mm	1985/1989		CO-1315	
A-10	->	TAPA-PÓ DO CILINDRO DE RODA	1985/1989		TA-0314	

Tabela de Conversão	Polegadas	9/16"	5/8"	11/16"	7/10"	3/4"	13/16"	7/8"	15/16"	1"	1 1/16"	1 1/8"	1 1/4"	1 3/8"	1 1/2"	1 5/8"	1 3/4"	1 27/32"	2"
	Milímetros	14,28mm	15,87mm	17,46mm	17,78mm	19,05mm	20,63mm	22,22mm	23,81mm	25,40mm	26,98mm	28,57mm	31,75mm	34,92mm	38,10mm	41,27mm	44,45mm	46,83mm	50,80mm

VEÍCULO		DESCRIÇÃO	ANOS	OBSERVAÇÃO	REF.	IMAGEM
<b>GM - CHEVROLET</b>						
A-20		CILINDRO MESTRE DE EMBREAGEM 22,22mm	1993/1996		C-2626	
A-20		CILINDRO AUXILIAR DE EMBREAGEM 20,63mm	1993/1996		C-2627	
A-20		SERVO FREIO 200mm	1985/1988		C-5621	
A-20		VÁLVULA DE RETENÇÃO DE VÁCUO	1985/1988		C-1755	
A-20		CILINDRO MESTRE DUPLA 25,40mm	1985/1988		C-2054	
A-20		CILINDRO MESTRE DUPLA 28,57mm	1989/1992		C-2044	
A-20		CILINDRO MESTRE DUPLA 28,57mm	1993/1996		C-2045	
A-20		REPARO DO CILINDRO MESTRE DUPLA 25,40mm	1985/1988		C-1092	
A-20		REPARO DO CILINDRO MESTRE DUPLA 28,57mm	1989/1992		C-1114	
A-20		REPARO DO CILINDRO MESTRE DUPLA 28,57mm	1993/1996		C-1125	
A-20		RESERVATÓRIO C/ TAMPAS	1985/1987		C-0105	
A-20		RESERVATÓRIO C/ TAMPAS E AVISO DE NÍVEL	1988/1996		C-0109	
A-20		VEDANTE DO CILINDRO MESTRE	1985/1993		VE-0203	
A-20	<	REPARO DE VEDAÇÃO DA PINÇA 79,00mm	1985/1992	(2 RODAS)	C-1500	
A-20	<	REPARO DE VEDAÇÃO DA PINÇA 54,00mm	1993/1996		C-1542	
A-20	<	TAPA-PÓ DO PINO DE GUIA	1993/1996		TA-1312	
A-20	->	CILINDRO DE RODA ESQUERDA 22,22mm	1985/1992		C-3444	
A-20	->	CILINDRO DE RODA DIREITA 22,22mm	1985/1992		C-3445	
A-20	->	CILINDRO DE RODA ESQUERDA 23,81mm	1993/1996		C-3441	

Tabela de Conversão	Polegadas	9/16"	5/8"	11/16"	7/10"	3/4"	13/16"	7/8"	15/16"	1"	1 1/16"	1 1/8"	1 1/4"	1 3/8"	1 1/2"	1 5/8"	1 3/4"	1 27/32"	2"
	Milímetros	14,28mm	15,87mm	17,46mm	17,78mm	19,05mm	20,63mm	22,22mm	23,81mm	25,40mm	26,98mm	28,57mm	31,75mm	34,92mm	38,10mm	41,27mm	44,45mm	46,83mm	50,80mm

VEÍCULO		DESCRIÇÃO	ANOS	OBSERVAÇÃO	REF.	IMAGEM
<b>GM - CHEVROLET</b>						
A-20	->	CILINDRO DE RODA DIREITA 23,81mm	1993/1996		C-3442	
A-20	->	REPARO DO CILINDRO DE RODA 22,22mm	1985/1992		C-1407	
A-20	->	REPARO DO CILINDRO DE RODA 23,81mm	1993/1996		C-1405	
A-20	->	COPO DO CILINDRO DE RODA 22,22mm	1985/1992		CO-1315	
A-20	->	COPO DO CILINDRO DE RODA 23,81mm	1993/1996		CO-1311	
A-20	->	TAPA-PÓ DO CILINDRO DE RODA	1985/1996		TA-0314	
AGILE		CILINDRO MESTRE DUPLA 20,63mm	2010/2011	S/ABS	C-2082	
AGILE		CILINDRO MESTRE DUPLA 20,63mm	2012/...	S/ABS	C-2174	
AGILE		REPARO DO CILINDRO MESTRE DUPLA 20,63mm	2010/2011	S/ABS	C-1161	
AGILE		RESERVATÓRIO C/ TAMPÃO E AVISO DE NÍVEL	2010/...	S/ABS	C-0106	
AGILE		VEDANTE DO CILINDRO MESTRE	2010/...	S/ABS	VE-0204	
AGILE	->	CILINDRO DE RODA 19,05mm	2010/...		C-3410	
AGILE	->	REPARO DO CILINDRO DE RODA 19,05mm	2010/...		C-1543	
AGILE	->	GAXETA DO CILINDRO DE RODA 19,05mm	2010/...		GA-0307	
AGILE	->	TAPA-PÓ DO CILINDRO DE RODA	2010/...		TA-0369	
AGILE		MANGUEIRA DO RESPIRO DO MOTOR	2010/...		C-9017	
AVEO	->	CILINDRO DE RODA 20,63mm	2004 / 2011	MOTOR 1.6	C-3541	
AVEO	->	CILINDRO DE RODA 20,63mm	2006 / 2011	AVEO 5	C-3541	
ASTRA		CILINDRO MESTRE DE EMBREAGEM 15,87mm	1999/2011		C-2644	
ASTRA		CIL. ATUADOR CONCÊNTRICO DE EMBREAGEM	1999/2003	MOTOR 2.0 16V (F-23)	C-2705	

Tabela de Conversão	Polegadas	9/16"	5/8"	11/16"	7/10"	3/4"	13/16"	7/8"	15/16"	1"	1 1/16"	1 1/8"	1 1/4"	1 3/8"	1 1/2"	1 5/8"	1 3/4"	1 27/32"	2"
	Milímetros	14,28mm	15,87mm	17,46mm	17,78mm	19,05mm	20,63mm	22,22mm	23,81mm	25,40mm	26,98mm	28,57mm	31,75mm	34,92mm	38,10mm	41,27mm	44,45mm	46,83mm	50,80mm



VEÍCULO		DESCRIÇÃO	ANOS	OBSERVAÇÃO	REF.	IMAGEM
<b>GM - CHEVROLET</b>						
ASTRA		CIL. ATUADOR CONCÊNTRICO DE EMBREAGEM	1999/2011	MOTOR 1.8/2.0 8V (F-17)	C-2709	
ASTRA		CIL. ATUADOR CONCÊNTRICO DE EMBREAGEM	2004/2005	MOTOR 2.0 16V (F-17)	C-2709	
ASTRA		SERVO FREIO 230mm	1995/1996	SIST. ATE	C-5632	
ASTRA		SERVO FREIO 230mm	1995/1996	SIST. DELCO	C-5642	
ASTRA		SERVO FREIO 230mm	1999/2001	MOD. GL S/ABS	C-5660	
ASTRA		SERVO FREIO 230mm	2002/2011	S/ABS	C-5660	
ASTRA		CILINDRO MESTRE DUPL0 22,22mm	1995/1996	SIST. ATE	C-2083	
ASTRA		CILINDRO MESTRE DUPL0 22,22mm	1999/2001	MOD. GL S/ABS	C-2094	
ASTRA		CILINDRO MESTRE DUPL0 23,81mm	1999/2001	MOD. GLS	C-2097	
ASTRA		CILINDRO MESTRE DUPL0 23,81mm	1999/2001	MOD. GL C/ABS	C-2097	
ASTRA		CILINDRO MESTRE DUPL0 22,22mm	2002/2011	S/ABS	C-2094	

Tabela de Conversão	Polegadas	9/16"	5/8"	11/16"	7/10"	3/4"	13/16"	7/8"	15/16"	1"	1 1/16"	1 1/8"	1 1/4"	1 3/8"	1 1/2"	1 5/8"	1 3/4"	1 27/32"	2"
	Milímetros		14,28mm	15,87mm	17,46mm	17,78mm	19,05mm	20,63mm	22,22mm	23,81mm	25,40mm	26,98mm	28,57mm	31,75mm	34,92mm	38,10mm	41,27mm	44,45mm	46,83mm

VEÍCULO		DESCRIÇÃO	ANOS	OBSERVAÇÃO	REF.	IMAGEM
<b>GM - CHEVROLET</b>						
ASTRA		CILINDRO MESTRE DUPL0 23,81mm	2002/2011	C/ABS	C-2097	
ASTRA		REPARO DO CILINDRO MESTRE DUPL0 22,22mm	1995/1996	SIST. ATE	C-1140	
ASTRA		REPARO DO CILINDRO MESTRE DUPL0 22,22mm	1995/1996	SIST. DELCO	C-1154	
ASTRA		REPARO DO CILINDRO MESTRE DUPL0 22,22mm	1999/2001	MOD. GL S/ABS	C-1171	
ASTRA		REPARO DO CILINDRO MESTRE DUPL0 22,22mm	2002/2011	S/ABS	C-1171	
ASTRA		RESERVATÓRIO C/ TAMP0 E AVISO DE NÍVEL	1995/1996	SIST. ATE	C-0106	
ASTRA		VEDANTE DO CILINDRO MESTRE	1995/1996	SIST. ATE	VE-0204	
ASTRA		VEDANTE DO CILINDRO MESTRE	1995/1996	SIST. DELCO	VE-0206	
ASTRA		VEDANTE DO CILINDRO MESTRE	1999/1999	C/ CIL. DELPHI	VE-0206	
ASTRA		VEDANTE DO CILINDRO MESTRE	1999/2011		VE-0204	
ASTRA	<-	REPARO DE VEDAÇÃO DA PINÇA 52,00mm	1995/1996		C-1565	
ASTRA	<-	REPARO DE VEDAÇÃO DA PINÇA 54,00mm	1999/2011	MOTOR 1.8 8V S/ ABS C/DISCO 236mm	C-1419	
ASTRA	<-	REPARO DE VEDAÇÃO DA PINÇA 57,00mm	1999/2011	MOTOR 2.0 16V	C-1567	
ASTRA	->	CILINDRO DE RODA 19,05mm	1995/2005		C-3410	
ASTRA	->	CILINDRO DE RODA 22,22mm	2005/2011		C-3521	
ASTRA	->	REPARO DO CILINDRO DE RODA 19,05mm	1995/2005		C-1543	
ASTRA	->	REPARO DO CILINDRO DE RODA 22,22mm	2005/2011		C-1531	
ASTRA	->	GAXETA DO CILINDRO DE RODA 19,05mm	1995/2005		GA-0307	
ASTRA	->	COPO DO CILINDRO DE RODA 22,22mm	2005/2011		CO-1315	
ASTRA	->	TAPA-PÓ DO CILINDRO DE RODA	1995/2005		TA-0369	
ASTRA	->	TAPA-PÓ DO CILINDRO DE RODA	2005/2011		TA-0321	
ASTRA	->	REPARO DE VEDAÇÃO DA PINÇA 35,00mm	1999/2011		C-1541	
BLAZER		CILINDRO MESTRE DE EMBREAGEM 19,05mm	1996/2000	MOTOR 2.2 GASOLINA/2.5 DIESEL	C-2624	
BLAZER		CILINDRO MESTRE DE EMBREAGEM 19,05mm	1996/2000	MOTOR 4.3 V6	C-2646	
BLAZER		CILINDRO MESTRE DE EMBREAGEM 19,05mm	2001/2011	MOTOR 2.4 GASOLINA	C-2624	
BLAZER		CILINDRO MESTRE DE EMBREAGEM 19,05mm	2001/2011	MOTOR 4.3 V6/2.8 DIESEL	C-2646	

BUSCA POR VEÍCULOS

Tabela de Conversão	Polegadas	9/16"	5/8"	11/16"	7/10"	3/4"	13/16"	7/8"	15/16"	1"	1 1/16"	1 1/8"	1 1/4"	1 3/8"	1 1/2"	1 5/8"	1 3/4"	1 27/32"	2"
	Milímetros	14,28mm	15,87mm	17,46mm	17,78mm	19,05mm	20,63mm	22,22mm	23,81mm	25,40mm	26,98mm	28,57mm	31,75mm	34,92mm	38,10mm	41,27mm	44,45mm	46,83mm	50,80mm

VEÍCULO		DESCRIÇÃO	ANOS	OBSERVAÇÃO	REF.	IMAGEM
<b>GM - CHEVROLET</b>						
BLAZER		CILINDRO AUXILIAR DE EMBREAGEM 20,63mm	1996/2000	MOTOR 2.2 GASOLINA/2.5 DIESEL	C-2625	
BLAZER		CIL. ATUADOR CONCÊNTRICO DE EMBREAGEM	1996/2000	MOTOR 4.3 V6	C-2704	
BLAZER		CILINDRO AUXILIAR DE EMBREAGEM 20,63mm	2001/2011	MOTOR 2.4 GASOLINA	C-2625	
BLAZER		CIL. ATUADOR CONCÊNTRICO DE EMBREAGEM	2001/2011	MOTOR 4.3 V6/2.8 DIESEL	C-2704	
BLAZER		VÁLVULA DE RETENÇÃO DE VÁCUO	1996/2011		C-1755	
BLAZER		CILINDRO MESTRE DUPL0 25,40mm	1996/2011	S/ABS	C-2073	
BLAZER		CILINDRO MESTRE DUPL0 25,40mm	1996/2011	C/ABS NAS RODAS TRASEIRAS	C-2073	
BLAZER		REPARO DO CILINDRO MESTRE DUPL0 25,40mm	1996/2011	S/ABS	C-1133	
BLAZER		REPARO DO CILINDRO MESTRE DUPL0 25,40mm	1996/2011	C/ABS NAS RODAS TRASEIRAS	C-1133	
BLAZER		VEDANTE DO CILINDRO MESTRE	1996/2011		VE-0204	
BLAZER	<	REPARO DE VEDAÇÃO DA PINÇA 47,00mm	1996/2011	C/ TRACÇÃO 4X4	C-1452	
BLAZER	<	REPARO DE VEDAÇÃO DA PINÇA 66,00mm	1996/2011	C/ TRACÇÃO 4X2	C-1547	
BLAZER	->	CILINDRO DE RODA ESQUERDA 23,81mm	1996/2011	C/FREIO 280 X 63mm	C-3417	
BLAZER	->	CILINDRO DE RODA DIREITA 23,81mm	1996/2011	C/FREIO 280 X 63mm	C-3418	
BLAZER	->	CILINDRO DE RODA ESQUERDA 22,22mm	1997/2011	C/FREIO 280 X 51mm	C-3456	
BLAZER	->	CILINDRO DE RODA DIREITA 22,22mm	1997/2011	C/FREIO 280 X 51mm	C-3457	
BLAZER	->	REPARO DO CILINDRO DE RODA 23,81mm	1996/2011	C/FREIO 280 X 63mm	C-1405	

Tabela de Conversão	Polegadas	9/16"	5/8"	11/16"	7/10"	3/4"	13/16"	7/8"	15/16"	1"	1 1/16"	1 1/8"	1 1/4"	1 3/8"	1 1/2"	1 5/8"	1 3/4"	1 27/32"	2"
	Milímetros	14,28mm	15,87mm	17,46mm	17,78mm	19,05mm	20,63mm	22,22mm	23,81mm	25,40mm	26,98mm	28,57mm	31,75mm	34,92mm	38,10mm	41,27mm	44,45mm	46,83mm	50,80mm

VEÍCULO		DESCRIÇÃO	ANOS	OBSERVAÇÃO	REF.	IMAGEM
<b>GM - CHEVROLET</b>						
BLAZER	->	REPARO DO CILINDRO DE RODA 22,22mm	1997/2011	C/FREIO 280 X 51mm	C-1407	
BLAZER	->	COPO DO CILINDRO DE RODA 23,81mm	1996/2011	C/FREIO 280 X 63mm	CO-1311	
BLAZER	->	COPO DO CILINDRO DE RODA 22,22mm	1997/2011	C/FREIO 280 X 51mm	CO-1315	
BLAZER	->	TAPA-PÓ DO CILINDRO DE RODA	1996/2011		TA-0314	
BLAZER		MANGUEIRA DO FILTRO DE AR	1998/2000	MOTOR 2.2 MPFI	C-9027	
BONANZA		CILINDRO MESTRE DE EMBREAGEM 22,22mm	1993/1996		C-2626	
BONANZA		CILINDRO AUXILIAR DE EMBREAGEM 20,63mm	1993/1996		C-2627	
BONANZA		CILINDRO MESTRE DUPLO 28,57mm	1990/1992		C-2044	
BONANZA		CILINDRO MESTRE DUPLO 28,57mm	1993/1996	EXCETO TURBO	C-2045	
BONANZA		CILINDRO MESTRE DUPLO 28,57mm	1993/1996	MOTOR 4.0 TURBO	C-2088	
BONANZA		REPARO DO CILINDRO MESTRE DUPLO 28,57mm	1990/1992		C-1114	
BONANZA		REPARO DO CILINDRO MESTRE DUPLO 28,57mm	1993/1996		C-1125	
BONANZA		RESERVATÓRIO C/ TAMPÃO E AVISO DE NÍVEL	1990/1996		C-0109	
BONANZA		VEDANTE DO CILINDRO MESTRE	1990/1996		VE-0203	
BONANZA	<	REPARO DE VEDAÇÃO DA PINÇA 79,00mm	1990/1992	(2 RODAS)	C-1500	
BONANZA	<	REPARO DE VEDAÇÃO DA PINÇA 54,00mm	1993/1996		C-1542	
BONANZA	<	TAPA-PÓ DO PINO DE GUIA	1993/1996		TA-1312	
BONANZA	->	CILINDRO DE RODA ESQUERDA 22,22mm	1990/1992		C-3444	
BONANZA	->	CILINDRO DE RODA DIREITA 22,22mm	1990/1992		C-3445	
BONANZA	->	CILINDRO DE RODA ESQUERDA 23,81mm	1993/1996		C-3441	

BUSCA POR VEÍCULOS

Tabela de Conversão	Polegadas	9/16"	5/8"	11/16"	7/10"	3/4"	13/16"	7/8"	15/16"	1"	1 1/16"	1 1/8"	1 1/4"	1 3/8"	1 1/2"	1 5/8"	1 3/4"	1 27/32"	2"
	Milímetros	14,28mm	15,87mm	17,46mm	17,78mm	19,05mm	20,63mm	22,22mm	23,81mm	25,40mm	26,98mm	28,57mm	31,75mm	34,92mm	38,10mm	41,27mm	44,45mm	46,83mm	50,80mm

VEÍCULO		DESCRIÇÃO	ANOS	OBSERVAÇÃO	REF.	IMAGEM
<b>GM - CHEVROLET</b>						
BONANZA	->	CILINDRO DE RODA DIREITA 23,81mm	1993/1996		C-3442	
BONANZA	->	REPARO DO CILINDRO DE RODA 22,22mm	1990/1992		C-1407	
BONANZA	->	REPARO DO CILINDRO DE RODA 23,81mm	1993/1996		C-1405	
BONANZA	->	COPO DO CILINDRO DE RODA 22,22mm	1990/1992		CO-1315	
BONANZA	->	COPO DO CILINDRO DE RODA 23,81mm	1993/1996		CO-1311	
BONANZA	->	TAPA-PÓ DO CILINDRO DE RODA	1990/1996		TA-0314	
C-10/14/15/16		SERVO FREIO 200mm	1979/1984		C-5618	
C-10/14/15/16		SERVO FREIO 200mm	1985/1988		C-5621	
C-10/14/15/16		VÁLVULA DE RETENÇÃO DE VÁCUO	1979/1989		C-1755	
C-10/14/15/16		CILINDRO MESTRE DUPL0 25,40mm C/ RESERV.	1973/1978		C-2134	
C-10/14/15/16		CILINDRO MESTRE DUPL0 25,40mm C/ RESERV.	1979/1984		C-2052	
C-10/14/15/16		CILINDRO MESTRE DUPL0 25,40mm	1985/1988		C-2054	
C-10/14/15/16		CILINDRO MESTRE DUPL0 28,57mm	1989/1989		C-2044	
C-10/14/15/16		REPARO DO CILINDRO MESTRE SIMPLES 25,40mm	1968/1973		C-1051	
C-10/14/15/16		REPARO DO CILINDRO MESTRE DUPL0 25,40mm	1973/1976		C-1092	
C-10/14/15/16		REPARO DO CILINDRO MESTRE DUPL0 25,40mm	1977/1978		C-1082	
C-10/14/15/16		REPARO DO CILINDRO MESTRE DUPL0 25,40mm	1979/1989		C-1092	
C-10/14/15/16		REPARO DO CILINDRO MESTRE DUPL0 28,57mm	1989/1989		C-1114	
C-10/14/15/16		RESERVATÓRIO C/ TAMP	1973/1987		C-0105	
C-10/14/15/16		RESERVATÓRIO C/ TAMP E AVISO DE NÍVEL	1988/1989		C-0109	
C-10/14/15/16		VEDANTE DO CILINDRO MESTRE	1973/1989		VE-0203	
C-10/14/15/16	<-	CILINDRO DE RODA ESQUERDA 28,57mm	1968/1975		C-3421	
C-10/14/15/16	<-	CILINDRO DE RODA DIREITA 28,57mm	1968/1975		C-3422	

Tabela de Conversão	Polegadas	9/16"	5/8"	11/16"	7/10"	3/4"	13/16"	7/8"	15/16"	1"	1 1/16"	1 1/8"	1 1/4"	1 3/8"	1 1/2"	1 5/8"	1 3/4"	1 27/32"	2"
	Milímetros	14,28mm	15,87mm	17,46mm	17,78mm	19,05mm	20,63mm	22,22mm	23,81mm	25,40mm	26,98mm	28,57mm	31,75mm	34,92mm	38,10mm	41,27mm	44,45mm	46,83mm	50,80mm









VEÍCULO		DESCRIÇÃO	ANOS	OBSERVAÇÃO	REF.	IMAGEM
<b>GM - CHEVROLET</b>						
C-10/14/15/16	<-	CILINDRO DE RODA ESQUERDA 28,57mm	1975/1978		C-3419	
C-10/14/15/16	<-	CILINDRO DE RODA DIREITA 28,57mm	1975/1978		C-3420	
C-10/14/15/16	<-	REPARO DO CILINDRO DE RODA 28,57mm	1968/1978		C-1422	
C-10/14/15/16	<-	COPO DO CILINDRO DE RODA 28,57mm	1968/1978		CO-1309	
C-10/14/15/16	<-	TAPA-PÓ DO CILINDRO DE RODA	1968/1978		TA-0349	
C-10/14/15/16	<-	REPARO DE VEDAÇÃO DA PINÇA 79,00mm	1979/1989	(2 RODAS)	C-1500	
C-10/14/15/16	->	CILINDRO DE RODA ESQUERDA 25,40mm	1968/1978		C-3392	
C-10/14/15/16	->	CILINDRO DE RODA DIREITA 25,40mm	1968/1978		C-3393	
C-10/14/15/16	->	CILINDRO DE RODA ESQUERDA 22,22mm	1979/1989		C-3444	
C-10/14/15/16	->	CILINDRO DE RODA DIREITA 22,22mm	1979/1989		C-3445	
C-10/14/15/16	->	REPARO DO CILINDRO DE RODA 25,40mm	1968/1978		C-1416	
C-10/14/15/16	->	REPARO DO CILINDRO DE RODA 22,22mm	1979/1989		C-1407	
C-10/14/15/16	->	COPO DO CILINDRO DE RODA 25,40mm	1968/1978		CO-1307	
C-10/14/15/16	->	COPO DO CILINDRO DE RODA 22,22mm	1979/1989		CO-1315	
C-10/14/15/16	->	TAPA-PÓ DO CILINDRO DE RODA	1968/1989		TA-0314	
C-20		CILINDRO MESTRE DE EMBREAGEM 22,22mm	1993/1996		C-2626	
C-20		CILINDRO AUXILIAR DE EMBREAGEM 20,63mm	1993/1996		C-2627	
C-20		SERVO FREIO 200mm	1985/1988		C-5621	
C-20		VÁLVULA DE RETENÇÃO DE VÁCUO	1985/1988		C-1755	

BUSCA POR VEÍCULOS

Tabela de Conversão	Polegadas	9/16"	5/8"	11/16"	7/10"	3/4"	13/16"	7/8"	15/16"	1"	1 1/16"	1 1/8"	1 1/4"	1 3/8"	1 1/2"	1 5/8"	1 3/4"	1 27/32"	2"
	Milímetros	14,28mm	15,87mm	17,46mm	17,78mm	19,05mm	20,63mm	22,22mm	23,81mm	25,40mm	26,98mm	28,57mm	31,75mm	34,92mm	38,10mm	41,27mm	44,45mm	46,83mm	50,80mm

VEÍCULO		DESCRIÇÃO	ANOS	OBSERVAÇÃO	REF.	IMAGEM
<b>GM - CHEVROLET</b>						
C-20		CILINDRO MESTRE DUPL0 25,40mm	1985/1988		C-2054	
C-20		CILINDRO MESTRE DUPL0 28,57mm	1989/1992		C-2044	
C-20		CILINDRO MESTRE DUPL0 28,57mm	1993/1996		C-2045	
C-20		REPARO DO CILINDRO MESTRE DUPL0 25,40mm	1985/1988		C-1092	
C-20		REPARO DO CILINDRO MESTRE DUPL0 28,57mm	1989/1992		C-1114	
C-20		REPARO DO CILINDRO MESTRE DUPL0 28,57mm	1993/1996		C-1125	
C-20		RESERVATÓRIO C/ TAMP A	1985/1987		C-0105	
C-20		RESERVATÓRIO C/ TAMP A E AVISO DE NÍVEL	1988/1996		C-0109	
C-20		VEDANTE DO CILINDRO MESTRE	1985/1996		VE-0203	
C-20	<-	REPARO DE VEDAÇÃO DA PINÇA 79,00mm	1985/1992	(2 RODAS)	C-1500	
C-20	<-	REPARO DE VEDAÇÃO DA PINÇA 54,00mm	1993/1996		C-1542	
C-20	<-	TAPA-PÓ DO PINO DE GUIA	1993/1996		TA-1312	
C-20	->	CILINDRO DE RODA ESQUERDA 22,22mm	1985/1992		C-3444	
C-20	->	CILINDRO DE RODA DIREITA 22,22mm	1985/1992		C-3445	
C-20	->	CILINDRO DE RODA ESQUERDA 23,81mm	1993/1996		C-3441	
C-20	->	CILINDRO DE RODA DIREITA 23,81mm	1993/1996		C-3442	
C-20	->	REPARO DO CILINDRO DE RODA 22,22mm	1985/1992		C-1407	
C-20	->	REPARO DO CILINDRO DE RODA 23,81mm	1993/1996		C-1405	
C-20	->	COPO DO CILINDRO DE RODA 22,22mm	1985/1992		CO-1315	
C-20	->	COPO DO CILINDRO DE RODA 23,81mm	1993/1996		CO-1311	
C-20	->	TAPA-PÓ DO CILINDRO DE RODA	1985/1996		TA-0314	
CALIBRA		SERVO FREIO 230mm	1993/1995	SIST. ATE	C-5632	

Tabela de Conversão	Polegadas	9/16"	5/8"	11/16"	7/10"	3/4"	13/16"	7/8"	15/16"	1"	1 1/16"	1 1/8"	1 1/4"	1 3/8"	1 1/2"	1 5/8"	1 3/4"	1 27/32"	2"
	Milímetros	14,28mm	15,87mm	17,46mm	17,78mm	19,05mm	20,63mm	22,22mm	23,81mm	25,40mm	26,98mm	28,57mm	31,75mm	34,92mm	38,10mm	41,27mm	44,45mm	46,83mm	50,80mm

VEÍCULO		DESCRIÇÃO	ANOS	OBSERVAÇÃO	REF.	IMAGEM
<b>GM - CHEVROLET</b>						
CALIBRA		SERVO FREIO 230mm	1993/1995	SIST. DELCO	C-5642	
CALIBRA		REPARO DO CILINDRO MESTRE DUPL0 22,22mm	1993/1995	SIST. ATE C/ABS	C-1160	
CALIBRA		VEDANTE DO CILINDRO MESTRE	1993/1995	SIST. ATE	VE-0204	
CALIBRA		VEDANTE DO CILINDRO MESTRE	1993/1995	SIST. DELCO	VE-0206	
CALIBRA	<-	REPARO DE VEDAÇÃO DA PINÇA 52,00mm	1993/1995		C-1565	
CALIBRA	->	REPARO DE VEDAÇÃO DA PINÇA 35,00mm	1993/1995		C-1541	
CARAVAN		SERVO FREIO 200mm	1979/1980	USE C/ CILINDRO C-2010	C-5634	
CARAVAN		SERVO FREIO 200mm	1981/1990	SIST. BOSCH	C-5612	
CARAVAN		SERVO FREIO 200mm	1981/1990	SIST. VARGA	C-5634	
CARAVAN		SERVO FREIO 230mm	1991/1992		C-5645	
CARAVAN		VÁLVULA DE RETENÇÃO DE VÁCUO BRANCA	1975/1982	P/ SERVO VARGA FD150/SM180	C-1750	
CARAVAN		VÁLVULA DE RETENÇÃO DE VÁCUO	1975/1992	SIST. VARGA	C-1753	
CARAVAN		VÁLVULA DE RETENÇÃO DE VÁCUO	1981/1990	SIST. BOSCH	C-1755	
CARAVAN		CILINDRO MESTRE DUPL0 22,22mm	1979/1980	USE C/ SERVO C-5634*	C-2010	
CARAVAN		CILINDRO MESTRE DUPL0 22,22mm	1981/1990	SIST. BOSCH	C-2016	
CARAVAN		CILINDRO MESTRE DUPL0 22,22mm	1981/1992	SIST. VARGA	C-2010	
CARAVAN		REPARO DO CILINDRO MESTRE DUPL0 22,22mm	1975/1980		C-1085	
CARAVAN		REPARO DO CILINDRO MESTRE DUPL0 22,22mm	1981/1989	P/ CILINDRO BENDIX 2258655	C-1002	
CARAVAN		REPARO DO CILINDRO MESTRE DUPL0 22,22mm	1981/1990	SIST. BOSCH	C-1117	
CARAVAN		REPARO DO CILINDRO MESTRE DUPL0 22,22mm	1981/1992	P/ CILINDRO VARGA	C-1008	
CARAVAN		VEDANTE DO CILINDRO MESTRE	1975/1992	SIST. VARGA	VE-0200	
CARAVAN		VEDANTE DO CILINDRO MESTRE	1981/1990	SIST. BOSCH	VE-0203	
CARAVAN	<-	REPARO DE VEDAÇÃO DA PINÇA 54,00mm	1975/1992	SIST. VARGA	C-1480	
CARAVAN	<-	REPARO DE VEDAÇÃO DA PINÇA 57,00mm	1979/1991	SIST. ATE	C-1501	

BUSCA POR VEÍCULOS

Tabela de Conversão	Polegadas	9/16"	5/8"	11/16"	7/10"	3/4"	13/16"	7/8"	15/16"	1"	1 1/16"	1 1/8"	1 1/4"	1 3/8"	1 1/2"	1 5/8"	1 3/4"	1 27/32"	2"
	Milímetros	14,28mm	15,87mm	17,46mm	17,78mm	19,05mm	20,63mm	22,22mm	23,81mm	25,40mm	26,98mm	28,57mm	31,75mm	34,92mm	38,10mm	41,27mm	44,45mm	46,83mm	50,80mm























VEÍCULO		DESCRIÇÃO	ANOS	OBSERVAÇÃO	REF.	IMAGEM
<b>GM - CHEVROLET</b>						
CARAVAN	->	CILINDRO DE RODA ESQUERDA 19,05mm	1975/1978		C-3395	
CARAVAN	->	CILINDRO DE RODA DIREITA 19,05mm	1975/1978		C-3396	
CARAVAN	->	CILINDRO DE RODA ESQUERDA 19,05mm	1979/1980		C-3468	
CARAVAN	->	CILINDRO DE RODA DIREITA 19,05mm	1979/1980		C-3469	
CARAVAN	->	CILINDRO DE RODA ESQUERDA 22,22mm	1981/1982	SIST. BENDIX	C-3446	
CARAVAN	->	CILINDRO DE RODA DIREITA 22,22mm	1981/1982	SIST. BENDIX	C-3447	
CARAVAN	->	CILINDRO DE RODA ESQUERDA 22,22mm	1981/1992	SIST. VARGA	C-3371	
CARAVAN	->	CILINDRO DE RODA DIREITA 22,22mm	1981/1992	SIST. VARGA	C-3372	
CARAVAN	->	REPARO DO CILINDRO DE RODA 19,05mm	1975/1980		C-1481	
CARAVAN	->	REPARO DO CILINDRO DE RODA 22,22mm	1981/1982	SIST. BENDIX	C-1442	
CARAVAN	->	REPARO DO CILINDRO DE RODA 22,22mm	1981/1992	SIST. VARGA	C-1439	
CARAVAN	->	GAXETA DO CILINDRO DE RODA 19,05mm	1975/1980		GA-0307	
CARAVAN	->	COPO DO CILINDRO DE RODA 22,22mm	1981/1982	SIST. BENDIX	CO-1315	
CARAVAN	->	GAXETA DO CILINDRO DE RODA 22,22mm	1981/1992	SIST. VARGA	GA-0316	
CARAVAN	->	TAPA-PÓ DO CILINDRO DE RODA	1975/1992	SIST. VARGA	TA-0312	
CARAVAN	->	TAPA-PÓ DO CILINDRO DE RODA	1981/1982	SIST. BENDIX	TA-0310	
CARAVAN	->	REPARO DE VEDAÇÃO DA PINÇA 43,00mm	1991/1992		C-1535	
CARAVAN	->	TAPA PÓ DO PINO DE GUIA	1991/1992		TA-0322	
CELTA		SERVO FREIO 200mm	2001/2007		C-5659	

Tabela de Conversão	Polegadas	9/16"	5/8"	11/16"	7/10"	3/4"	13/16"	7/8"	15/16"	1"	1 1/16"	1 1/8"	1 1/4"	1 3/8"	1 1/2"	1 5/8"	1 3/4"	1 27/32"	2"
	Milímetros		14,28mm	15,87mm	17,46mm	17,78mm	19,05mm	20,63mm	22,22mm	23,81mm	25,40mm	26,98mm	28,57mm	31,75mm	34,92mm	38,10mm	41,27mm	44,45mm	46,83mm

VEÍCULO		DESCRIÇÃO	ANOS	OBSERVAÇÃO	REF.	IMAGEM
<b>GM - CHEVROLET</b>						
CELTA		SERVO FREIO 200mm	2007/...		C-5668	
CELTA		CILINDRO MESTRE DUPLO 20,63mm	2001/2005		C-2092	
CELTA		CILINDRO MESTRE DUPLO 20,63mm	2005/2007		C-2157	
CELTA		CILINDRO MESTRE DUPLO 20,63mm	2007/...		C-2168	
CELTA		REPARO DO CILINDRO MESTRE DUPLO 20,63mm	2001/...		C-1170	
CELTA		RESERVATÓRIO C/ TAMPA E AVISO DE NÍVEL	2001/...		C-0106	
CELTA		VEDANTE DO CILINDRO MESTRE	2001/...		VE-0204	
CELTA	<	REPARO DE VEDAÇÃO DA PINÇA 48,00mm	2001/...		C-1550	
CELTA	->	CILINDRO DE RODA 17,78mm	2001/2002		C-3439	
CELTA	->	CILINDRO DE RODA 14,28mm	2003/...		C-3500	
CELTA	->	REPARO DO CILINDRO DE RODA 17,78mm	2001/2002		C-1566	
CELTA	->	REPARO DO CILINDRO DE RODA 14,28mm	2003/...		C-1519	
CELTA	->	GAXETA DO CILINDRO DE RODA 17,78mm	2001/2002		GA-0301	
CELTA	->	GAXETA DO CILINDRO DE RODA 14,28mm	2003/...		GA-0311	
CELTA	->	TAPA-PÓ DO CILINDRO DE RODA	2001/2002		TA-0312	
CELTA	->	TAPA-PÓ DO CILINDRO DE RODA	2003/...		TA-0338	
CELTA		MANGUEIRA DO FILTRO DE AR	2001/2002		C-9009	
CELTA		MANGUEIRA DO FILTRO DE AR C/ SENSOR	2001/2002		C-9010	
CELTA		MANGUEIRA DO FILTRO DE AR	2003/2008		C-9008	

BUSCA POR VEÍCULOS

Tabela de Conversão	Polegadas	9/16"	5/8"	11/16"	7/10"	3/4"	13/16"	7/8"	15/16"	1"	1 1/16"	1 1/8"	1 1/4"	1 3/8"	1 1/2"	1 5/8"	1 3/4"	1 27/32"	2"
	Milímetros	14,28mm	15,87mm	17,46mm	17,78mm	19,05mm	20,63mm	22,22mm	23,81mm	25,40mm	26,98mm	28,57mm	31,75mm	34,92mm	38,10mm	41,27mm	44,45mm	46,83mm	50,80mm











VEÍCULO		DESCRIÇÃO	ANOS	OBSERVAÇÃO	REF.	IMAGEM
<b>GM - CHEVROLET</b>						
CELTA		MANGUEIRA DO FILTRO DE AR	2009/...		C-9018	
CELTA		MANGUEIRA DO RESPIRO DO MOTOR	2006/...		C-9017	
CHEVETTE		SERVO FREIO 200mm	1977/1986		C-5602	
CHEVETTE		SERVO FREIO 200mm	1987/1994	SIST. ATE	C-5616	
CHEVETTE		SERVO FREIO 200mm	1987/1994	SIST. BOSCH	C-5619	
CHEVETTE		VÁLVULA DE RETENÇÃO DE VÁCUO	1977/1994		C-1755	
CHEVETTE		CILINDRO MESTRE DUPL0 20,63mm	1973/1980	USE C/ RESERV. C-0100	C-2001	
CHEVETTE		CILINDRO MESTRE DUPL0 20,63mm	1981/1986	C/SERVO E S/SERVO	C-2001	
CHEVETTE		CILINDRO MESTRE DUPL0 20,63mm	1987/1994	SIST. ATE	C-2032	
CHEVETTE		CILINDRO MESTRE DUPL0 20,63mm	1987/1994	SIST. BOSCH	C-2034	
CHEVETTE		REPARO DO CILINDRO MESTRE DUPL0 20,63mm	1973/1986	C/SERVO E S/SERVO	C-1003	
CHEVETTE		REPARO DO CILINDRO MESTRE DUPL0 19,05mm	1976/1980	P/ CILINDRO BENDIX 3/4" C/SERVO E S/SERVO	C-1090	
CHEVETTE		REPARO DO CILINDRO MESTRE DUPL0 20,63mm	1987/1994	SIST. ATE	C-1029	
CHEVETTE		REPARO DO CILINDRO MESTRE DUPL0 20,63mm	1987/1994	SIST. BOSCH	C-1030	
CHEVETTE		RESERVATÓRIO C/ TAMP0 E AVISO DE NÍVEL	1973/1986		C-0100	
CHEVETTE		RESERVATÓRIO C/ TAMP0 E AVISO DE NÍVEL	1987/1994	SIST. ATE	C-0104	
CHEVETTE		VEDANTE DO CILINDRO MESTRE	1973/1994	SIST. BOSCH	VE-0203	
CHEVETTE		VEDANTE DO CILINDRO MESTRE	1987/1994	SIST. ATE	VE-0204	
CHEVETTE	<-	COPO DO CILINDRO DE RODA 25,40mm	1973/1974		CO-1307	

Tabela de Conversão	Polegadas	9/16"	5/8"	11/16"	7/10"	3/4"	13/16"	7/8"	15/16"	1"	1 1/16"	1 1/8"	1 1/4"	1 3/8"	1 1/2"	1 5/8"	1 3/4"	1 27/32"	2"
	Milímetros		14,28mm	15,87mm	17,46mm	17,78mm	19,05mm	20,63mm	22,22mm	23,81mm	25,40mm	26,98mm	28,57mm	31,75mm	34,92mm	38,10mm	41,27mm	44,45mm	46,83mm

VEÍCULO		DESCRIÇÃO	ANOS	OBSERVAÇÃO	REF.	IMAGEM
<b>GM - CHEVROLET</b>						
CHEVETTE	<-	REPARO DE VEDAÇÃO DA PINÇA 48,00mm	1973/1994		C-1490	
CHEVETTE	->	CILINDRO DE RODA 19,05mm	1973/1986	SIST. BOSCH	C-3354	
CHEVETTE	->	CILINDRO DE RODA 19,05mm	1978/1986	SIST. VARGA	C-3394	
CHEVETTE	->	CILINDRO DE RODA 22,22mm	1987/1994	SIST. VARGA	C-3373	
CHEVETTE	->	CILINDRO DE RODA 22,22mm	1987/1994	SIST. BOSCH	C-3374	
CHEVETTE	->	REPARO DO CILINDRO DE RODA 19,05mm	1973/1986	SIST. BOSCH	C-1492	
CHEVETTE	->	REPARO DO CILINDRO DE RODA 17,46mm	1977/1980	P/ CILINDRO BENDIX 11/16"	C-1499	
CHEVETTE	->	REPARO DO CILINDRO DE RODA 17,46mm	1978/1980	P/ CILINDRO VARGA 11/16"	C-1515	
CHEVETTE	->	REPARO DO CILINDRO DE RODA 19,05mm	1978/1986	SIST. VARGA	C-1481	
CHEVETTE	->	REPARO DO CILINDRO DE RODA 22,22mm	1987/1994	SIST. VARGA	C-1439	
CHEVETTE	->	REPARO DO CILINDRO DE RODA 22,22mm	1987/1994	SIST. BOSCH	C-1442	
CHEVETTE	->	COPO DO CILINDRO DE RODA 19,05mm	1973/1986	SIST. BOSCH	CO-1312	
CHEVETTE	->	COPO DO CILINDRO DE RODA 17,46mm	1977/1980	P/ CILINDRO BENDIX 11/16"	CO-1305	
CHEVETTE	->	GAXETA DO CILINDRO DE RODA 17,46mm	1978/1980	P/ CILINDRO VARGA 11/16"	GA-0309	
CHEVETTE	->	GAXETA DO CILINDRO DE RODA 19,05mm	1978/1986	SIST. VARGA	GA-0307	
CHEVETTE	->	COPO DO CILINDRO DE RODA 22,22mm	1987/1994	SIST. BOSCH	CO-1315	
CHEVETTE	->	GAXETA DO CILINDRO DE RODA 22,22mm	1987/1994	SIST. VARGA	GA-0316	
CHEVETTE	->	TAPA-PÓ DO CILINDRO DE RODA	1973/1986	SIST. BOSCH	TA-1300	
CHEVETTE	->	TAPA-PÓ DO CILINDRO DE RODA	1978/1994	SIST. VARGA	TA-0312	
CHEVETTE	->	TAPA-PÓ DO CILINDRO DE RODA	1987/1994	SIST. BOSCH	TA-0310	
CHEVY		SERVO FREIO 200mm	1983/1986		C-5602	
CHEVY		SERVO FREIO 200mm	1987/1995	SIST. ATE	C-5616	
CHEVY		SERVO FREIO 200mm	1987/1995	SIST. BOSCH	C-5619	
CHEVY		VÁLVULA DE RETENÇÃO DE VÁCUO	1983/1995		C-1755	
CHEVY		CILINDRO MESTRE DUPLA 20,63mm	1983/1986	C/SERVO E S/SERVO	C-2001	

BUSCA POR VEÍCULOS

Tabela de Conversão	Polegadas	9/16"	5/8"	11/16"	7/10"	3/4"	13/16"	7/8"	15/16"	1"	1 1/16"	1 1/8"	1 1/4"	1 3/8"	1 1/2"	1 5/8"	1 3/4"	1 27/32"	2"
	Milímetros	14,28mm	15,87mm	17,46mm	17,78mm	19,05mm	20,63mm	22,22mm	23,81mm	25,40mm	26,98mm	28,57mm	31,75mm	34,92mm	38,10mm	41,27mm	44,45mm	46,83mm	50,80mm





VEÍCULO		DESCRIÇÃO	ANOS	OBSERVAÇÃO	REF.	IMAGEM
<b>GM - CHEVROLET</b>						
CHEVY		CILINDRO MESTRE DUPL0 20,63mm	1987/1995	SIST. ATE	C-2032	
CHEVY		CILINDRO MESTRE DUPL0 20,63mm	1987/1995	SIST. BOSCH	C-2034	
CHEVY		REPARO DO CILINDRO MESTRE DUPL0 20,63mm	1983/1986	C/SERVO E S/SERVO	C-1003	
CHEVY		REPARO DO CILINDRO MESTRE DUPL0 20,63mm	1987/1995	SIST. ATE	C-1029	
CHEVY		REPARO DO CILINDRO MESTRE DUPL0 20,63mm	1987/1995	SIST. BOSCH	C-1030	
CHEVY		RESERVATÓRIO C/ TAMP A E AVISO DE NÍVEL	1983/1986		C-0100	
CHEVY		RESERVATÓRIO C/ TAMP A E AVISO DE NÍVEL	1987/1995	SIST. ATE	C-0104	
CHEVY		VEDANTE DO CILINDRO MESTRE	1983/1995	SIST. BOSCH	VE-0203	
CHEVY		VEDANTE DO CILINDRO MESTRE	1987/1995	SIST. ATE	VE-0204	
CHEVY	<-	REPARO DE VEDAÇÃO DA PINÇA 48,00mm	1983/1995		C-1490	
CHEVY	->	CILINDRO DE RODA 19,05mm	1983/1986	SIST. BOSCH	C-3354	
CHEVY	->	CILINDRO DE RODA 19,05mm	1983/1986	SIST. VARGA	C-3394	
CHEVY	->	CILINDRO DE RODA 22,22mm	1987/1995	SIST. VARGA	C-3373	
CHEVY	->	CILINDRO DE RODA 22,22mm	1987/1995	SIST. BOSCH	C-3374	
CHEVY	->	REPARO DO CILINDRO DE RODA 19,05mm	1983/1986	SIST. VARGA	C-1481	
CHEVY	->	REPARO DO CILINDRO DE RODA 19,05mm	1983/1986	SIST. BOSCH	C-1492	
CHEVY	->	REPARO DO CILINDRO DE RODA 22,22mm	1987/1995	SIST. VARGA	C-1439	
CHEVY	->	REPARO DO CILINDRO DE RODA 22,22mm	1987/1995	SIST. BOSCH	C-1442	
CHEVY	->	COPO DO CILINDRO DE RODA 19,05mm	1983/1986	SIST. BOSCH	CO-1312	
CHEVY	->	GAXETA DO CILINDRO DE RODA 19,05mm	1983/1986	SIST. VARGA	GA-0307	
CHEVY	->	COPO DO CILINDRO DE RODA 22,22mm	1987/1995	SIST. BOSCH	CO-1315	
CHEVY	->	GAXETA DO CILINDRO DE RODA 22,22mm	1987/1995	SIST. VARGA	GA-0316	
CHEVY	->	TAPA-PÓ DO CILINDRO DE RODA	1983/1986	SIST. BOSCH	TA-1300	
CHEVY	->	TAPA-PÓ DO CILINDRO DE RODA	1983/1995	SIST. VARGA	TA-0312	
CHEVY	->	TAPA-PÓ DO CILINDRO DE RODA	1987/1995	SIST. BOSCH	TA-0310	
COBALT		CIL. ATUADOR CONCÊNTRICO DE EMBREAGEM	2011/...	MOTOR 1.4	C-2709	



Tabela de Conversão	Polegadas	9/16"	5/8"	11/16"	7/10"	3/4"	13/16"	7/8"	15/16"	1"	1 1/16"	1 1/8"	1 1/4"	1 3/8"	1 1/2"	1 5/8"	1 3/4"	1 27/32"	2"
	Milímetros	14,28mm	15,87mm	17,46mm	17,78mm	19,05mm	20,63mm	22,22mm	23,81mm	25,40mm	26,98mm	28,57mm	31,75mm	34,92mm	38,10mm	41,27mm	44,45mm	46,83mm	50,80mm

VEÍCULO		DESCRIÇÃO	ANOS	OBSERVAÇÃO	REF.	IMAGEM
<b>GM - CHEVROLET</b>						
COBALT	->	CILINDRO DE RODA 19,05mm	2012/...		C-3426	
COBALT	->	REPARO DO CILINDRO DE RODA 19,05mm	2012/...		C-1543	
COBALT	->	GAXETA DO CILINDRO DE RODA 19,05mm	2012/...		GA-0307	
COBALT	->	TAPA-PÓ DO CILINDRO DE RODA	2012/...		TA-0369	
COBALT		MANGUEIRA DO FILTRO DE AR	2012/...		C-9021	
CORSA		CILINDRO MESTRE DE EMBREAGEM 15,87mm	2002/2012		C-2662	
CORSA		CIL. ATUADOR CONCÊNTRICO DE EMBREAGEM	2002/2012	MOTOR 1.0	C-2709	
CORSA		CIL. ATUADOR CONCÊNTRICO DE EMBREAGEM	2002/2012	MOTOR 1.4 / 1.8	C-2709	
CORSA		SERVO FREIO 200mm	1994/1995	SIST. DELCO, USE C/ CIL. C-2108	C-5622	
CORSA		SERVO FREIO 200mm	1994/1998	MOTOR 8V SIST. TEVES	C-5622	
CORSA		SERVO FREIO 200mm	1997/1998	MOTOR 16V SIST. ATE	C-5647	
CORSA		SERVO FREIO 200mm	1998/2002	MOTOR 8V SIST. ATE	C-5641	
CORSA		SERVO FREIO 200mm	1998/2002	MOTOR 16V SIST. ATE	C-5646	
CORSA		SERVO FREIO 230mm	2002/2012		C-5666	

Tabela de Conversão	Polegadas	9/16"	5/8"	11/16"	7/10"	3/4"	13/16"	7/8"	15/16"	1"	1 1/16"	1 1/8"	1 1/4"	1 3/8"	1 1/2"	1 5/8"	1 3/4"	1 27/32"	2"
	Milímetros	14,28mm	15,87mm	17,46mm	17,78mm	19,05mm	20,63mm	22,22mm	23,81mm	25,40mm	26,98mm	28,57mm	31,75mm	34,92mm	38,10mm	41,27mm	44,45mm	46,83mm	50,80mm

VEÍCULO		DESCRIÇÃO	ANOS	OBSERVAÇÃO	REF.	IMAGEM
<b>GM - CHEVROLET</b>						
CORSA		CILINDRO MESTRE DUPL0 20,63mm	1994/1998	SIST. ATE	C-2041	
CORSA		CILINDRO MESTRE DUPL0 20,63mm	1998/2002	SIST. ATE	C-2082	
CORSA		CILINDRO MESTRE DUPL0 22,22mm	2002/2012	S/ABS	C-2143	
CORSA		REPARO DO CILINDRO MESTRE DUPL0 20,63mm	1994/1995	SIST. DELCO S/ABS	C-1129	
CORSA		REPARO DO CILINDRO MESTRE DUPL0 20,63mm	1994/1998	P/ CILINDRO ATE 5825	C-1132	
CORSA		REPARO DO CILINDRO MESTRE DUPL0 20,63mm	1998/2002	SIST. ATE	C-1161	
CORSA		REPARO DO CILINDRO MESTRE DUPL0 22,22mm	2002/2012	S/ABS	C-1171	
CORSA		RESERVATÓRIO C/ TAMP A E AVISO DE NÍVEL	1994/2002	SIST. ATE	C-0106	
CORSA		VEDANTE DO CILINDRO MESTRE	1994/1995	SIST. DELCO	VE-0206	
CORSA		VEDANTE DO CILINDRO MESTRE	1994/2002	SIST. ATE	VE-0204	
CORSA		VEDANTE DO CILINDRO MESTRE	2002/2012		VE-0204	
CORSA	<	REPARO DE VEDAÇÃO DA PINÇA 48,00mm	1994/2002	SIST. ATE	C-1550	
CORSA	<	REPARO DE VEDAÇÃO DA PINÇA 48,00mm	1997/2012	SIST. VARGA	C-1559	
CORSA	->	CILINDRO DE RODA 19,05mm	1994/2012		C-3410	
CORSA	->	REPARO DO CILINDRO DE RODA 19,05mm	1994/2012		C-1543	
CORSA	->	GAXETA DO CILINDRO DE RODA 19,05mm	1994/2012		GA-0307	
CORSA	->	TAPA-PÓ DO CILINDRO DE RODA	1994/2012		TA-0369	
CORSA		MANGUEIRA DA TOMADA DE AR	2002/2012		C-9020	
CORSA		MANGUEIRA DO FILTRO DE AR	1996/2002	MOTOR 1.0/1.6 MPFI 8V	C-9009	
CORSA		MANGUEIRA DO FILTRO DE AR C/ SENSOR	1996/2002	MOTOR 1.0/1.6 MPFI 8V	C-9010	
CORSA		MANGUEIRA DO RESPIRO DO MOTOR	2006/2012		C-9017	

Tabela de Conversão	Polegadas	9/16"	5/8"	11/16"	7/10"	3/4"	13/16"	7/8"	15/16"	1"	1 1/16"	1 1/8"	1 1/4"	1 3/8"	1 1/2"	1 5/8"	1 3/4"	1 27/32"	2"
	Milímetros	14,28mm	15,87mm	17,46mm	17,78mm	19,05mm	20,63mm	22,22mm	23,81mm	25,40mm	26,98mm	28,57mm	31,75mm	34,92mm	38,10mm	41,27mm	44,45mm	46,83mm	50,80mm

VEÍCULO		DESCRIÇÃO	ANOS	OBSERVAÇÃO	REF.	IMAGEM
<b>GM - CHEVROLET</b>						
CORSA		JOGO ANÉIS VEDAÇÃO COLETOR DE ADMISSÃO	2006/2009	MOTOR 1.8 FLEXPPOWER 8V	C-9502	
CORSA CLASSIC		SERVO FREIO 200mm	2003/2009		C-5641	
CORSA CLASSIC		SERVO FREIO 200mm	2009/...	1.0 S/ABS	C-5672	
CORSA CLASSIC		CILINDRO MESTRE DUPLO 20,63mm	2003/2009		C-2082	
CORSA CLASSIC		CILINDRO MESTRE DUPLO 20,63mm	2010/...		C-2174	
CORSA CLASSIC		REPARO DO CILINDRO MESTRE DUPLO 20,63mm	2003/2009		C-1161	
CORSA CLASSIC		RESERVATÓRIO C/ TAMP A E AVISO DE NÍVEL	2003/...		C-0106	
CORSA CLASSIC		VEDANTE DO CILINDRO MESTRE	2003/...		VE-0204	
CORSA CLASSIC	<-	REPARO DE VEDAÇÃO DA PINÇA 48,00mm	2003/...	SIST. ATE	C-1550	
CORSA CLASSIC	<-	REPARO DE VEDAÇÃO DA PINÇA 48,00mm	2003/...	SIST. VARGA	C-1559	
CORSA CLASSIC	>	CILINDRO DE RODA 19,05mm	2003/...		C-3410	
CORSA CLASSIC	>	REPARO DO CILINDRO DE RODA 19,05mm	2003/...		C-1543	
CORSA CLASSIC	>	GAXETA DO CILINDRO DE RODA 19,05mm	2003/...		GA-0307	
CORSA CLASSIC	>	TAPA-PÓ DO CILINDRO DE RODA	2003/...		TA-0369	
CORSA CLASSIC		MANGUEIRA DO FILTRO DE AR	2003/2004	MOTOR 1.6 MPFI	C-9009	
CORSA CLASSIC		MANGUEIRA DO FILTRO DE AR C/ SENSOR	2003/2004	MOTOR 1.6 MPFI	C-9010	
CORSA CLASSIC		MANGUEIRA DO FILTRO DE AR	2003/2008	MOTOR 1.0/1.6 VHC	C-9008	

BUSCA POR VEÍCULOS

Tabela de Conversão	Polegadas	9/16"	5/8"	11/16"	7/10"	3/4"	13/16"	7/8"	15/16"	1"	1 1/16"	1 1/8"	1 1/4"	1 3/8"	1 1/2"	1 5/8"	1 3/4"	1 27/32"	2"
	Milímetros	14,28mm	15,87mm	17,46mm	17,78mm	19,05mm	20,63mm	22,22mm	23,81mm	25,40mm	26,98mm	28,57mm	31,75mm	34,92mm	38,10mm	41,27mm	44,45mm	46,83mm	50,80mm



VEÍCULO		DESCRIÇÃO	ANOS	OBSERVAÇÃO	REF.	IMAGEM
<b>GM - CHEVROLET</b>						
CORSA CLASSIC		MANGUEIRA DO FILTRO DE AR	2009/...		C-9018	
CORSA PICK-UP		SERVO FREIO 200mm	1995/1998	SIST. ATE	C-5622	
CORSA PICK-UP		SERVO FREIO 200mm	1998/2003	SIST. ATE	C-5641	
CORSA PICK-UP		CILINDRO MESTRE DUPL0 20,63mm	1995/1998	SIST. ATE	C-2041	
CORSA PICK-UP		CILINDRO MESTRE DUPL0 20,63mm	1998/2003	SIST. ATE	C-2082	
CORSA PICK-UP		REPARO DO CILINDRO MESTRE DUPL0 20,63mm	1995/1998	SIST. DELCO S/ABS	C-1129	
CORSA PICK-UP		REPARO DO CILINDRO MESTRE DUPL0 20,63mm	1995/1998	P/ CILINDRO ATE 5825	C-1132	
CORSA PICK-UP		REPARO DO CILINDRO MESTRE DUPL0 20,63mm	1998/2003	SIST. ATE	C-1161	
CORSA PICK-UP		RESERVATÓRIO C/ TAMP A E AVISO DE NÍVEL	1995/2003	SIST. ATE	C-0106	
CORSA PICK-UP		VEDANTE DO CILINDRO MESTRE	1995/1998	SIST. DELCO	VE-0206	
CORSA PICK-UP		VEDANTE DO CILINDRO MESTRE	1995/2003	SIST. ATE	VE-0204	
CORSA PICK-UP	<-	REPARO DE VEDAÇÃO DA PINÇA 48,00mm	1995/2003	SIST. ATE	C-1550	
CORSA PICK-UP	<-	REPARO DE VEDAÇÃO DA PINÇA 48,00mm	1997/2003	SIST. VARGA	C-1559	
CORSA PICK-UP	->	CILINDRO DE RODA ESQUERDA 22,22mm	1995/2003		C-3369	
CORSA PICK-UP	->	CILINDRO DE RODA DIREITA 22,22mm	1995/2003		C-3370	
CORSA PICK-UP	->	REPARO DO CILINDRO DE RODA 22,22mm	1995/2003		C-1524	
CORSA PICK-UP	->	GAXETA DO CILINDRO DE RODA 22,22mm	1995/2003		GA-0314	
CORSA PICK-UP	->	TAPA-PÓ DO CILINDRO DE RODA	1995/2003		TA-0353	
CORSA PICK-UP		MANGUEIRA DO FILTRO DE AR	1996/2003	MOTOR 1.6 MPFI 8V	C-9009	
CORSA PICK-UP		MANGUEIRA DO FILTRO DE AR C/ SENSOR	1996/2003	MOTOR 1.6 MPFI 8V	C-9010	

Tabela de Conversão	Polegadas	9/16"	5/8"	11/16"	7/10"	3/4"	13/16"	7/8"	15/16"	1"	1 1/16"	1 1/8"	1 1/4"	1 3/8"	1 1/2"	1 5/8"	1 3/4"	1 27/32"	2"
	Milímetros	14,28mm	15,87mm	17,46mm	17,78mm	19,05mm	20,63mm	22,22mm	23,81mm	25,40mm	26,98mm	28,57mm	31,75mm	34,92mm	38,10mm	41,27mm	44,45mm	46,83mm	50,80mm

VEÍCULO		DESCRIÇÃO	ANOS	OBSERVAÇÃO	REF.	IMAGEM
<b>GM - CHEVROLET</b>						
CRUZE		CILINDRO MESTRE DE EMBREAGEM 15,87mm	2013/...	1.8	C-2688	
D-10		SERVO FREIO 200mm	1979/1984		C-5618	
D-10		VÁLVULA DE RETENÇÃO DE VÁCUO	1979/1984		C-1755	
D-10		CILINDRO MESTRE DUPLA 25,40mm C/ RESERV.	1979/1984		C-2052	
D-10		REPARO DO CILINDRO MESTRE DUPLA 25,40mm	1979/1984		C-1092	
D-10		RESERVATÓRIO C/ TAMPA	1979/1984		C-0105	
D-10		VEDANTE DO CILINDRO MESTRE	1979/1984		VE-0203	
D-10	<-	REPARO DE VEDAÇÃO DA PINÇA 79,00mm	1979/1984	(2 RODAS)	C-1500	
D-10	->	CILINDRO DE RODA ESQUERDA 25,40mm	1979/1984		C-3362	
D-10	->	CILINDRO DE RODA DIREITA 25,40mm	1979/1984		C-3363	
D-10	->	REPARO DO CILINDRO DE RODA 25,40mm	1979/1984		C-1416	
D-10	->	COPO DO CILINDRO DE RODA 25,40mm	1979/1984		CO-1307	
D-10	->	TAPA-PÓ DO CILINDRO DE RODA	1979/1984		TA-0314	
D-20		CILINDRO MESTRE DE EMBREAGEM 22,22mm	1993/1996		C-2626	
D-20		CILINDRO AUXILIAR DE EMBREAGEM 20,63mm	1993/1996		C-2627	
D-20		SERVO FREIO 200mm	1985/1988		C-5621	
D-20		VÁLVULA DE RETENÇÃO DE VÁCUO	1985/1988		C-1755	
D-20		CILINDRO MESTRE DUPLA 25,40mm	1985/1988		C-2054	

BUSCA POR VEÍCULOS

Tabela de Conversão	Polegadas	9/16"	5/8"	11/16"	7/10"	3/4"	13/16"	7/8"	15/16"	1"	1 1/16"	1 1/8"	1 1/4"	1 3/8"	1 1/2"	1 5/8"	1 3/4"	1 27/32"	2"
	Milímetros	14,28mm	15,87mm	17,46mm	17,78mm	19,05mm	20,63mm	22,22mm	23,81mm	25,40mm	26,98mm	28,57mm	31,75mm	34,92mm	38,10mm	41,27mm	44,45mm	46,83mm	50,80mm

VEÍCULO		DESCRIÇÃO	ANOS	OBSERVAÇÃO	REF.	IMAGEM
<b>GM - CHEVROLET</b>						
D-20		CILINDRO MESTRE DUPL0 28,57mm	1989/1992		C-2044	
D-20		CILINDRO MESTRE DUPL0 28,57mm	1993/1996	EXCETO TURBO	C-2045	
D-20		CILINDRO MESTRE DUPL0 28,57mm	1993/1996	MOTOR 4.0 TURBO	C-2088	
D-20		REPARO DO CILINDRO MESTRE DUPL0 25,40mm	1985/1988		C-1092	
D-20		REPARO DO CILINDRO MESTRE DUPL0 28,57mm	1989/1992		C-1114	
D-20		REPARO DO CILINDRO MESTRE DUPL0 28,57mm	1993/1996		C-1125	
D-20		RESERVATÓRIO C/ TAMP A	1985/1987		C-0105	
D-20		RESERVATÓRIO C/ TAMP A E AVISO DE NÍVEL	1988/1996		C-0109	
D-20		VEDANTE DO CILINDRO MESTRE	1985/1996		VE-0203	
D-20	<	REPARO DE VEDAÇÃO DA PINÇA 79,00mm	1985/1992	(2 RODAS)	C-1500	
D-20	<	REPARO DE VEDAÇÃO DA PINÇA 54,00mm	1993/1996		C-1542	
D-20	<	TAPA-PÓ DO PINO DE GUIA	1993/1996		TA-1312	
D-20	->	CILINDRO DE RODA ESQUERDA 25,40mm	1985/1992		C-3362	
D-20	->	CILINDRO DE RODA DIREITA 25,40mm	1985/1992		C-3363	
D-20	->	CILINDRO DE RODA ESQUERDA 23,81mm	1993/1996		C-3441	
D-20	->	CILINDRO DE RODA DIREITA 23,81mm	1993/1996		C-3442	
D-20	->	REPARO DO CILINDRO DE RODA 25,40mm	1985/1992		C-1416	
D-20	->	REPARO DO CILINDRO DE RODA 23,81mm	1993/1996		C-1405	
D-20	->	COPO DO CILINDRO DE RODA 25,40mm	1985/1992		CO-1307	
D-20	->	COPO DO CILINDRO DE RODA 23,81mm	1993/1996		CO-1311	
D-20	->	TAPA-PÓ DO CILINDRO DE RODA	1985/1996		TA-0314	
GRAND BLAZER		CILINDRO MESTRE DE EMBREAGEM 19,05mm	1998/2000		C-2638	

Tabela de Conversão	Polegadas	9/16"	5/8"	11/16"	7/10"	3/4"	13/16"	7/8"	15/16"	1"	1 1/16"	1 1/8"	1 1/4"	1 3/8"	1 1/2"	1 5/8"	1 3/4"	1 27/32"	2"
	Milímetros	14,28mm	15,87mm	17,46mm	17,78mm	19,05mm	20,63mm	22,22mm	23,81mm	25,40mm	26,98mm	28,57mm	31,75mm	34,92mm	38,10mm	41,27mm	44,45mm	46,83mm	50,80mm

VEÍCULO		DESCRIÇÃO	ANOS	OBSERVAÇÃO	REF.	IMAGEM
<b>GM - CHEVROLET</b>						
GRAND BLAZER		CILINDRO AUXILIAR DE EMBREAGEM 20,63mm	1998/2000		C-2627	
GRAND BLAZER	<-	REPARO DE VEDAÇÃO DA PINÇA 54,00mm	1998/2000		C-1542	
GRAND BLAZER	<-	TAPA-PÓ DO PINO DE GUIA	1998/2000		TA-1312	
GRAND BLAZER	->	CILINDRO DE RODA ESQUERDA 23,81mm	1998/1999		C-3441	
GRAND BLAZER	->	CILINDRO DE RODA DIREITA 23,81mm	1998/1999		C-3442	
GRAND BLAZER	->	CILINDRO DE RODA ESQUERDA 28,57mm	1999/2000		C-3492	
GRAND BLAZER	->	CILINDRO DE RODA DIREITA 28,57mm	1999/2000		C-3493	
GRAND BLAZER	->	REPARO DO CILINDRO DE RODA 23,81mm	1998/1999		C-1405	
GRAND BLAZER	->	REPARO DO CILINDRO DE RODA 28,57mm	1999/2000		C-1422	
GRAND BLAZER	->	COPO DO CILINDRO DE RODA 23,81mm	1998/1999		CO-1311	
GRAND BLAZER	->	COPO DO CILINDRO DE RODA 28,57mm	1999/2000		CO-1309	
GRAND BLAZER	->	TAPA-PÓ DO CILINDRO DE RODA	1998/1999		TA-0314	
GRAND BLAZER	->	TAPA-PÓ DO CILINDRO DE RODA	1999/2000		TA-0349	
IPANEMA		SERVO FREIO 200mm	1990/1998	SIST. VARGA E BOSCH	C-5614	
IPANEMA		VÁLVULA DE RETENÇÃO DE VÁCUO	1990/1998	SIST. VARGA E BOSCH	C-1755	
IPANEMA		CILINDRO MESTRE DUPLA 22,22mm	1990/1998	SIST. VARGA	C-2014	
IPANEMA		CILINDRO MESTRE DUPLA 22,22mm	1990/1998	SIST. BOSCH	C-2057	
IPANEMA		REPARO DO CILINDRO MESTRE DUPLA 22,22mm	1990/1998	SIST. VARGA E BOSCH	C-1109	
IPANEMA		RESERVATÓRIO C/ TAMPA E AVISO DE NÍVEL	1990/1998	SIST. VARGA S/ CHECK CONTROL	C-0103	
IPANEMA		VEDANTE DO CILINDRO MESTRE	1990/1998	SIST. VARGA	VE-0200	
IPANEMA		VEDANTE DO CILINDRO MESTRE	1990/1998	SIST. BOSCH	VE-0203	
IPANEMA	<-	REPARO DE VEDAÇÃO DA PINÇA 54,00mm	1990/1993		C-1525	
IPANEMA	<-	REPARO DE VEDAÇÃO DA PINÇA 54,00mm	1994/1997		C-1552	
IPANEMA	<-	REPARO DE VEDAÇÃO DA PINÇA 54,00mm	1997/1998		C-1568	
IPANEMA	<-	TAPA PÓ DO PINO DE GUIA	1990/1993		TA-0322	
IPANEMA	<-	TAPA-PÓ DO PINO DE GUIA	1994/1996		TA-0333	

BUSCA POR VEÍCULOS

Tabela de Conversão	Polegadas	9/16"	5/8"	11/16"	7/10"	3/4"	13/16"	7/8"	15/16"	1"	1 1/16"	1 1/8"	1 1/4"	1 3/8"	1 1/2"	1 5/8"	1 3/4"	1 27/32"	2"
	Milímetros	14,28mm	15,87mm	17,46mm	17,78mm	19,05mm	20,63mm	22,22mm	23,81mm	25,40mm	26,98mm	28,57mm	31,75mm	34,92mm	38,10mm	41,27mm	44,45mm	46,83mm	50,80mm

VEÍCULO		DESCRIÇÃO	ANOS	OBSERVAÇÃO	REF.	IMAGEM
<b>GM - CHEVROLET</b>						
IPANEMA	<-	TAPA PÓ DO PINO DE GUIA	1997/1998		TA-0322	
IPANEMA	->	CILINDRO DE RODA ESQUERDA 22,22mm	1990/1998	SIST. ATE	C-3369	
IPANEMA	->	CILINDRO DE RODA DIREITA 22,22mm	1990/1998	SIST. ATE	C-3370	
IPANEMA	->	CILINDRO DE RODA ESQUERDA 22,22mm	1990/1998	SIST. BOSCH	C-3408	
IPANEMA	->	CILINDRO DE RODA DIREITA 22,22mm	1990/1998	SIST. BOSCH	C-3409	
IPANEMA	->	REPARO DO CILINDRO DE RODA 22,22mm	1990/1998	SIST. ATE	C-1524	
IPANEMA	->	REPARO DO CILINDRO DE RODA 22,22mm	1990/1998	SIST. BOSCH	C-1531	
IPANEMA	->	COPO DO CILINDRO DE RODA 22,22mm	1990/1998	SIST. BOSCH	CO-1315	
IPANEMA	->	GAXETA DO CILINDRO DE RODA 22,22mm	1990/1998	SIST. ATE	GA-0314	
IPANEMA	->	TAPA-PÓ DO CILINDRO DE RODA	1990/1998	SIST. BOSCH	TA-0321	
IPANEMA	->	TAPA-PÓ DO CILINDRO DE RODA	1990/1998	SIST. ATE	TA-0353	
IPANEMA	->	REPARO DE VEDAÇÃO DA PINÇA 34,00mm	1992/1993		C-1537	
IPANEMA	->	REPARO DE VEDAÇÃO DA PINÇA 34,00mm	1994/1998		C-1553	
IPANEMA	->	TAPA PÓ DO PINO DE GUIA	1992/1993		TA-0322	
IPANEMA	->	TAPA-PÓ DO PINO DE GUIA	1994/1998		TA-0344	
KADETT		SERVO FREIO 200mm	1989/1998	SIST. VARGA E BOSCH	C-5614	
KADETT		VÁLVULA DE RETENÇÃO DE VÁCUO	1989/1998	SIST. VARGA E BOSCH	C-1755	
KADETT		CILINDRO MESTRE DUPL0 22,22mm	1989/1998	SIST. VARGA	C-2014	
KADETT		CILINDRO MESTRE DUPL0 22,22mm	1989/1998	SIST. BOSCH	C-2057	
KADETT		REPARO DO CILINDRO MESTRE DUPL0 22,22mm	1989/1998	SIST. VARGA E BOSCH	C-1109	
KADETT		RESERVATÓRIO C/ TAMPA E AVISO DE NÍVEL	1989/1998	SIST. VARGA S/ CHECK CONTROL	C-0103	
KADETT		VEDANTE DO CILINDRO MESTRE	1989/1998	SIST. VARGA	VE-0200	
KADETT		VEDANTE DO CILINDRO MESTRE	1989/1998	SIST. BOSCH	VE-0203	
KADETT	<-	REPARO DE VEDAÇÃO DA PINÇA 54,00mm	1989/1993		C-1525	
KADETT	<-	REPARO DE VEDAÇÃO DA PINÇA 54,00mm	1994/1997		C-1552	
KADETT	<-	REPARO DE VEDAÇÃO DA PINÇA 54,00mm	1997/1998		C-1568	
KADETT	<-	TAPA PÓ DO PINO DE GUIA	1989/1993		TA-0322	
KADETT	<-	TAPA-PÓ DO PINO DE GUIA	1994/1996		TA-0333	
KADETT	<-	TAPA PÓ DO PINO DE GUIA	1997/1998		TA-0322	

Tabela de Conversão	Polegadas	9/16"	5/8"	11/16"	7/10"	3/4"	13/16"	7/8"	15/16"	1"	1 1/16"	1 1/8"	1 1/4"	1 3/8"	1 1/2"	1 5/8"	1 3/4"	1 27/32"	2"
	Milímetros	14,28mm	15,87mm	17,46mm	17,78mm	19,05mm	20,63mm	22,22mm	23,81mm	25,40mm	26,98mm	28,57mm	31,75mm	34,92mm	38,10mm	41,27mm	44,45mm	46,83mm	50,80mm

VEÍCULO		DESCRIÇÃO	ANOS	OBSERVAÇÃO	REF.	IMAGEM
<b>GM - CHEVROLET</b>						
KADETT	->	CILINDRO DE RODA ESQUERDA 20,63mm	1989/1998	SIST. ATE	C-3405	
KADETT	->	CILINDRO DE RODA DIREITA 20,63mm	1989/1998	SIST. ATE	C-3406	
KADETT	->	CILINDRO DE RODA ESQUERDA 20,63mm	1989/1998	SIST. BOSCH	C-3414	
KADETT	->	CILINDRO DE RODA DIREITA 20,63mm	1989/1998	SIST. BOSCH	C-3415	
KADETT	->	REPARO DO CILINDRO DE RODA 20,63mm	1989/1998	SIST. ATE	C-1527	
KADETT	->	REPARO DO CILINDRO DE RODA 20,63mm	1989/1998	SIST. BOSCH	C-1536	
KADETT	->	COPO DO CILINDRO DE RODA 20,63mm	1989/1998	SIST. BOSCH	CO-1317	
KADETT	->	GAXETA DO CILINDRO DE RODA 20,63mm	1989/1998	SIST. ATE	GA-0213	
KADETT	->	TAPA-PÓ DO CILINDRO DE RODA	1989/1998	SIST. TEVES	TA-0303	
KADETT	->	TAPA-PÓ DO CILINDRO DE RODA	1989/1998	SIST. BOSCH	TA-0321	
KADETT	->	REPARO DE VEDAÇÃO DA PINÇA 34,00mm	1992/1993		C-1537	
KADETT	->	REPARO DE VEDAÇÃO DA PINÇA 34,00mm	1994/1998		C-1553	
KADETT	->	TAPA PÓ DO PINO DE GUIA	1992/1993		TA-0322	
KADETT	->	TAPA-PÓ DO PINO DE GUIA	1994/1998		TA-0344	
MARAJÓ		SERVO FREIO 200mm	1981/1986		C-5602	
MARAJÓ		SERVO FREIO 200mm	1987/1989	SIST. ATE	C-5616	
MARAJÓ		SERVO FREIO 200mm	1987/1989	SIST. BOSCH	C-5619	
MARAJÓ		VÁLVULA DE RETENÇÃO DE VÁCUO	1981/1989		C-1755	
MARAJÓ		CILINDRO MESTRE DUPLO 20,63mm	1981/1986	C/SERVO E S/SERVO	C-2001	
MARAJÓ		CILINDRO MESTRE DUPLO 20,63mm	1987/1989	SIST. ATE	C-2032	

BUSCA POR VEÍCULOS

Tabela de Conversão	Polegadas	9/16"	5/8"	11/16"	7/10"	3/4"	13/16"	7/8"	15/16"	1"	1 1/16"	1 1/8"	1 1/4"	1 3/8"	1 1/2"	1 5/8"	1 3/4"	1 27/32"	2"
	Milímetros	14,28mm	15,87mm	17,46mm	17,78mm	19,05mm	20,63mm	22,22mm	23,81mm	25,40mm	26,98mm	28,57mm	31,75mm	34,92mm	38,10mm	41,27mm	44,45mm	46,83mm	50,80mm









VEÍCULO		DESCRIÇÃO	ANOS	OBSERVAÇÃO	REF.	IMAGEM
<b>GM - CHEVROLET</b>						
MARAJÓ		CILINDRO MESTRE DUPL0 20,63mm	1987/1989	SIST. BOSCH	C-2034	
MARAJÓ		REPARO DO CILINDRO MESTRE DUPL0 20,63mm	1981/1986	C/SERVO E S/SERVO	C-1003	
MARAJÓ		REPARO DO CILINDRO MESTRE DUPL0 20,63mm	1987/1989	SIST. ATE	C-1029	
MARAJÓ		REPARO DO CILINDRO MESTRE DUPL0 20,63mm	1987/1989	SIST. BOSCH	C-1030	
MARAJÓ		RESERVATÓRIO C/ TAMP A E AVISO DE NÍVEL	1981/1986		C-0100	
MARAJÓ		RESERVATÓRIO C/ TAMP A E AVISO DE NÍVEL	1987/1989	SIST. ATE	C-0104	
MARAJÓ		VEDANTE DO CILINDRO MESTRE	1981/1989	SIST. BOSCH	VE-0203	
MARAJÓ		VEDANTE DO CILINDRO MESTRE	1987/1989	SIST. ATE	VE-0204	
MARAJÓ	<-	REPARO DE VEDAÇÃO DA PINÇA 48,00mm	1981/1989		C-1490	
MARAJÓ	->	CILINDRO DE RODA 19,05mm	1981/1986	SIST. BOSCH	C-3354	
MARAJÓ	->	CILINDRO DE RODA 19,05mm	1981/1986	SIST. VARGA	C-3394	
MARAJÓ	->	CILINDRO DE RODA 22,22mm	1987/1989	SIST. VARGA	C-3373	
MARAJÓ	->	CILINDRO DE RODA 22,22mm	1987/1989	SIST. BOSCH	C-3374	
MARAJÓ	->	REPARO DO CILINDRO DE RODA 19,05mm	1981/1986	SIST. VARGA	C-1481	
MARAJÓ	->	REPARO DO CILINDRO DE RODA 19,05mm	1981/1986	SIST. BOSCH	C-1492	
MARAJÓ	->	REPARO DO CILINDRO DE RODA 22,22mm	1987/1989	SIST. VARGA	C-1439	
MARAJÓ	->	REPARO DO CILINDRO DE RODA 22,22mm	1987/1989	SIST. BOSCH	C-1442	
MARAJÓ	->	COPO DO CILINDRO DE RODA 19,05mm	1981/1986	SIST. BOSCH	CO-1312	
MARAJÓ	->	GAXETA DO CILINDRO DE RODA 19,05mm	1981/1986	SIST. VARGA	GA-0307	
MARAJÓ	->	COPO DO CILINDRO DE RODA 22,22mm	1987/1989	SIST. BOSCH	CO-1315	
MARAJÓ	->	GAXETA DO CILINDRO DE RODA 22,22mm	1987/1989	SIST. VARGA	GA-0316	
MARAJÓ	->	TAPA-PÓ DO CILINDRO DE RODA	1981/1986	SIST. BOSCH	TA-1300	
MARAJÓ	->	TAPA-PÓ DO CILINDRO DE RODA	1981/1989	SIST. VARGA	TA-0312	
MARAJÓ	->	TAPA-PÓ DO CILINDRO DE RODA	1987/1989	SIST. BOSCH	TA-0310	
MERIVA		CILINDRO MESTRE DE EMBREAGEM 15,87mm	2003/2012	1.8 8V	C-2667	
MERIVA		CILINDRO MESTRE DE EMBREAGEM 15,87mm	TODOS	CÁMBIO F-17	C-2667	

Tabela de Conversão	Polegadas	9/16"	5/8"	11/16"	7/10"	3/4"	13/16"	7/8"	15/16"	1"	1 1/16"	1 1/8"	1 1/4"	1 3/8"	1 1/2"	1 5/8"	1 3/4"	1 27/32"	2"
	Milímetros	14,28mm	15,87mm	17,46mm	17,78mm	19,05mm	20,63mm	22,22mm	23,81mm	25,40mm	26,98mm	28,57mm	31,75mm	34,92mm	38,10mm	41,27mm	44,45mm	46,83mm	50,80mm

VEÍCULO		DESCRIÇÃO	ANOS	OBSERVAÇÃO	REF.	IMAGEM
<b>GM - CHEVROLET</b>						
MERIVA		CIL. ATUADOR CONCÊNTRICO DE EMBREAGEM	2003/2012		C-2709	
MERIVA		CILINDRO MESTRE DUPLO 23,81mm	2003/2012		C-2097	
MERIVA		VEDANTE DO CILINDRO MESTRE	2003/2012		VE-0204	
MERIVA	<-	REPARO DE VEDAÇÃO DA PINÇA 54,00mm	2003/2012		C-1419	
MERIVA	->	CILINDRO DE RODA 19,05mm	2003/2012		C-3410	
MERIVA	->	REPARO DO CILINDRO DE RODA 19,05mm	2003/2012		C-1543	
MERIVA	->	GAXETA DO CILINDRO DE RODA 19,05mm	2003/2012		GA-0307	
MERIVA	->	TAPA-PÓ DO CILINDRO DE RODA	2003/2012		TA-0369	
MERIVA	->	REPARO DE VEDAÇÃO DA PINÇA 35,00mm	2003/2012		C-1541	
MERIVA		MANGUEIRA DO RESPIRO DO MOTOR	2006/2012		C-9017	
MERIVA		JOGO ANÉIS VEDAÇÃO COLETOR DE ADMISSÃO	2006/2012	MOTOR 1.8 FLEXPOWER 8V	C-9502	
MONTANA		CILINDRO MESTRE DE EMBREAGEM 15,87mm	2004/2010		C-2662	
MONTANA		CIL. ATUADOR CONCÊNTRICO DE EMBREAGEM	2004/2010		C-2709	
MONTANA		SERVO FREIO 230mm	2004/2010		C-5666	
MONTANA		CILINDRO MESTRE DUPLO 22,22mm	2004/2010	S/ABS	C-2143	
MONTANA		CILINDRO MESTRE DUPLO 20,63mm	2011/2013	S/ABS	C-2082	
MONTANA		REPARO DO CILINDRO MESTRE DUPLO 22,22mm	2004/2010	S/ABS	C-1171	

BUSCA POR VEÍCULOS

Tabela de Conversão	Polegadas	9/16"	5/8"	11/16"	7/10"	3/4"	13/16"	7/8"	15/16"	1"	1 1/16"	1 1/8"	1 1/4"	1 3/8"	1 1/2"	1 5/8"	1 3/4"	1 27/32"	2"
	Milímetros	14,28mm	15,87mm	17,46mm	17,78mm	19,05mm	20,63mm	22,22mm	23,81mm	25,40mm	26,98mm	28,57mm	31,75mm	34,92mm	38,10mm	41,27mm	44,45mm	46,83mm	50,80mm











VEÍCULO		DESCRIÇÃO	ANOS	OBSERVAÇÃO	REF.	IMAGEM
<b>GM - CHEVROLET</b>						
MONTANA		REPARO DO CILINDRO MESTRE DUPLO 20,63mm	2011/2013	S/ABS	C-1161	
MONTANA		RESERVATÓRIO C/ TAMPÃO E AVISO DE NÍVEL	2011/...	S/ABS	C-0106	
MONTANA		VEDANTE DO CILINDRO MESTRE	2004/...	S/ABS	VE-0204	
MONTANA	<-	REPARO DE VEDAÇÃO DA PINÇA 48,00mm	2004/...		C-1559	
MONTANA	->	CILINDRO DE RODA 22,22mm	2004/...		C-3521	
MONTANA	->	REPARO DO CILINDRO DE RODA 22,22mm	2004/...		C-1531	
MONTANA	->	COPO DO CILINDRO DE RODA 22,22mm	2004/...		CO-1315	
MONTANA	->	TAPA-PÓ DO CILINDRO DE RODA	2004/...		TA-0321	
MONTANA		MANGUEIRA DA TOMADA DE AR	2004/2010		C-9020	
MONTANA		MANGUEIRA DO RESPIRO DO MOTOR	2006/...		C-9017	
MONTANA		JOGO ANÉIS VEDAÇÃO COLETOR DE ADMISSÃO	2006/2010	MOTOR 1.8 FLEXPPOWER 8V	C-9502	
MONZA		SERVO FREIO 230mm	1981/1987		C-5609	
MONZA		SERVO FREIO 230mm	1988/1996	SIST. VARGA E BOSCH S/ABS	C-5610	
MONZA		VÁLVULA DE RETENÇÃO DE VÁCUO	1981/1996	SIST. VARGA E BOSCH	C-1755	
MONZA		CILINDRO MESTRE DUPLO 20,63mm	1981/1987		C-2012	
MONZA		CILINDRO MESTRE DUPLO 22,22mm	1988/1996	SIST. VARGA S/ABS	C-2014	
MONZA		CILINDRO MESTRE DUPLO 22,22mm	1988/1996	SIST. BOSCH	C-2057	
MONZA		REPARO DO CILINDRO MESTRE DUPLO 20,63mm	1981/1987		C-1017	
MONZA		REPARO DO CILINDRO MESTRE DUPLO 22,22mm	1988/1996	SIST. VARGA E BOSCH S/ABS	C-1109	
MONZA		RESERVATÓRIO C/ TAMPÃO E AVISO DE NÍVEL	1982/1996	SIST. VARGA S/ABS	C-0103	
MONZA		VEDANTE DO CILINDRO MESTRE	1981/1996	SIST. VARGA S/ABS	VE-0200	

Tabela de Conversão	Polegadas	9/16"	5/8"	11/16"	7/10"	3/4"	13/16"	7/8"	15/16"	1"	1 1/16"	1 1/8"	1 1/4"	1 3/8"	1 1/2"	1 5/8"	1 3/4"	1 27/32"	2"
	Milímetros	14,28mm	15,87mm	17,46mm	17,78mm	19,05mm	20,63mm	22,22mm	23,81mm	25,40mm	26,98mm	28,57mm	31,75mm	34,92mm	38,10mm	41,27mm	44,45mm	46,83mm	50,80mm

VEÍCULO		DESCRIÇÃO	ANOS	OBSERVAÇÃO	REF.	IMAGEM
<b>GM - CHEVROLET</b>						
MONZA		VEDANTE DO CILINDRO MESTRE	1988/1996	SIST. BOSCH	VE-0203	
MONZA		VEDANTE DO CILINDRO MESTRE	1992/1996	C/ABS	VE-0204	
MONZA	<-	REPARO DE VEDAÇÃO DA PINÇA 48,00mm	1981/1987		C-1413	
MONZA	<-	REPARO DE VEDAÇÃO DA PINÇA 54,00mm	1988/1993		C-1525	
MONZA	<-	REPARO DE VEDAÇÃO DA PINÇA 54,00mm	1994/1996		C-1552	
MONZA	<-	TAPA PÓ DO PINO DE GUIA	1981/1993		TA-0322	
MONZA	<-	TAPA-PÓ DO PINO DE GUIA	1994/1996		TA-0333	
MONZA	->	CILINDRO DE RODA ESQUERDA 19,05mm	1981/1987		C-3364	
MONZA	->	CILINDRO DE RODA DIREITA 19,05mm	1981/1987		C-3365	
MONZA	->	CILINDRO DE RODA ESQUERDA 22,22mm	1988/1996	SIST. ATE	C-3369	
MONZA	->	CILINDRO DE RODA DIREITA 22,22mm	1988/1996	SIST. ATE	C-3370	
MONZA	->	CILINDRO DE RODA ESQUERDA 22,22mm	1988/1996	SIST. BOSCH	C-3408	
MONZA	->	CILINDRO DE RODA DIREITA 22,22mm	1988/1996	SIST. BOSCH	C-3409	
MONZA	->	REPARO DO CILINDRO DE RODA 19,05mm	1981/1987		C-1415	
MONZA	->	REPARO DO CILINDRO DE RODA 22,22mm	1988/1996	SIST. ATE	C-1524	
MONZA	->	REPARO DO CILINDRO DE RODA 22,22mm	1988/1996	SIST. BOSCH	C-1531	
MONZA	->	GAXETA DO CILINDRO DE RODA 19,05mm	1981/1987		GA-0307	
MONZA	->	COPO DO CILINDRO DE RODA 22,22mm	1988/1996	SIST. BOSCH	CO-1315	
MONZA	->	GAXETA DO CILINDRO DE RODA 22,22mm	1988/1996	SIST. ATE	GA-0314	
MONZA	->	TAPA-PÓ DO CILINDRO DE RODA	1981/1987		TA-0303	
MONZA	->	TAPA-PÓ DO CILINDRO DE RODA	1988/1996	SIST. BOSCH	TA-0321	
MONZA	->	TAPA-PÓ DO CILINDRO DE RODA	1988/1996	SIST. ATE	TA-0353	
MONZA	->	REPARO DE VEDAÇÃO DA PINÇA 34,00mm	1992/1993		C-1537	
MONZA	->	REPARO DE VEDAÇÃO DA PINÇA 34,00mm	1994/1996		C-1553	
MONZA	->	TAPA PÓ DO PINO DE GUIA	1992/1993		TA-0322	
MONZA	->	TAPA-PÓ DO PINO DE GUIA	1994/1996		TA-0344	
OMEGA		REPARO DO CILINDRO MESTRE DUPLO 22,22mm	1993/1998	4 CIL. S/ABS SIST. ATE	C-1122	
OMEGA		REPARO DO CILINDRO MESTRE DUPLO 22,22mm	1993/1998	4 CIL. C/ABS	C-1123	
OMEGA		REPARO DO CILINDRO MESTRE DUPLO 23,81mm	1993/1998	6 CIL. C/ABS E S/ABS	C-1124	
OMEGA		REPARO DO CILINDRO MESTRE DUPLO 22,22mm	1993/1998	4 CIL. S/ABS SIST. VARGA	C-1134	
OMEGA		RESERVATÓRIO C/ TAMPÃO E AVISO DE NÍVEL	1993/1998	4 CIL. S/ABS SIST. VARGA	C-0101	
OMEGA		VEDANTE DO CILINDRO MESTRE	1993/1998	SIST. VARGA	VE-0200	
OMEGA		VEDANTE DO CILINDRO MESTRE	1993/1998	SIST. ATE	VE-0204	
OMEGA	<-	REPARO DE VEDAÇÃO DA PINÇA 54,00mm	1993/1998	MOTOR 4 CIL.	C-1419	

BUSCA POR VEÍCULOS

Tabela de Conversão	Polegadas	9/16"	5/8"	11/16"	7/10"	3/4"	13/16"	7/8"	15/16"	1"	1 1/16"	1 1/8"	1 1/4"	1 3/8"	1 1/2"	1 5/8"	1 3/4"	1 27/32"	2"
	Milímetros	14,28mm	15,87mm	17,46mm	17,78mm	19,05mm	20,63mm	22,22mm	23,81mm	25,40mm	26,98mm	28,57mm	31,75mm	34,92mm	38,10mm	41,27mm	44,45mm	46,83mm	50,80mm









VEÍCULO		DESCRIÇÃO	ANOS	OBSERVAÇÃO	REF.	IMAGEM
<b>GM - CHEVROLET</b>						
OMEGA	<-	REPARO DE VEDAÇÃO DA PINÇA 57,00mm	1993/1998	MOTOR 6 CIL.	C-1538	
OMEGA	->	REPARO DE VEDAÇÃO DA PINÇA 38,00mm	1993/1998	MOTOR 6 CIL.	C-1539	
OMEGA	->	REPARO DE VEDAÇÃO DA PINÇA 35,00mm	1993/1998	MOTOR 4 CIL.	C-1541	
ONIX		CIL. ATUADOR CONCÊNTRICO DE EMBREAGEM	2012/...	MOTOR 1.0 E 1.4 8V	C-2709	
ONIX	->	CILINDRO DE RODA 19,05mm	2012/...		C-3426	
OPALA		SERVO FREIO 200mm	1979/1980	USE C/ CILINDRO C-2010	C-5634	
OPALA		SERVO FREIO 200mm	1981/1990	SIST. BOSCH	C-5612	
OPALA		SERVO FREIO 200mm	1981/1990	SIST. VARGA	C-5634	
OPALA		SERVO FREIO 230mm	1991/1992		C-5645	
OPALA		VÁLVULA DE RETENÇÃO DE VÁCUO BRANCA	1971/1990	P/ SERVO VARGA FD150/SM180	C-1750	
OPALA		VÁLVULA DE RETENÇÃO DE VÁCUO	1971/1992	SIST. VARGA	C-1753	
OPALA		VÁLVULA DE RETENÇÃO DE VÁCUO	1981/1990	SIST. BOSCH	C-1755	
OPALA		CILINDRO MESTRE DUPLO 22,22mm	1979/1980	USE C/ SERVO C-5634*	C-2010	
OPALA		CILINDRO MESTRE DUPLO 22,22mm	1981/1990	SIST. BOSCH	C-2016	
OPALA		CILINDRO MESTRE DUPLO 22,22mm	1981/1992	SIST. VARGA	C-2010	
OPALA		REPARO DO CILINDRO MESTRE DUPLO 22,22mm	1975/1980	C/SERVO	C-1085	
OPALA		REPARO DO CILINDRO MESTRE DUPLO 22,22mm	1981/1989	P/ CILINDRO BENDIX 2258655	C-1002	
OPALA		REPARO DO CILINDRO MESTRE DUPLO 22,22mm	1981/1990	SIST. BOSCH	C-1117	
OPALA		REPARO DO CILINDRO MESTRE DUPLO 22,22mm	1981/1992	P/ CILINDRO VARGA	C-1008	
OPALA		VEDANTE DO CILINDRO MESTRE	1971/1992	SIST. VARGA	VE-0200	
OPALA		VEDANTE DO CILINDRO MESTRE	1981/1991	SIST. BOSCH	VE-0203	

Tabela de Conversão	Polegadas	9/16"	5/8"	11/16"	7/10"	3/4"	13/16"	7/8"	15/16"	1"	1 1/16"	1 1/8"	1 1/4"	1 3/8"	1 1/2"	1 5/8"	1 3/4"	1 27/32"	2"
	Milímetros		14,28mm	15,87mm	17,46mm	17,78mm	19,05mm	20,63mm	22,22mm	23,81mm	25,40mm	26,98mm	28,57mm	31,75mm	34,92mm	38,10mm	41,27mm	44,45mm	46,83mm











VEÍCULO		DESCRIÇÃO	ANOS	OBSERVAÇÃO	REF.	IMAGEM
<b>GM - CHEVROLET</b>						
OPALA	<-	COPO DO CILINDRO DE RODA 25,40mm	1969/1969		<b>CO-1307</b>	
OPALA	<-	COPO DO CILINDRO DE RODA 28,57mm	1969/1972		<b>CO-1309</b>	
OPALA	<-	TAPA-PÓ DO CILINDRO DE RODA	1969/1972		<b>TA-1302</b>	
OPALA	<-	REPARO DE VEDAÇÃO DA PINÇA 54,00mm	1971/1992	SIST. VARGA	<b>C-1480</b>	
OPALA	<-	REPARO DE VEDAÇÃO DA PINÇA 57,00mm	1979/1991	SIST. ATE	<b>C-1501</b>	
OPALA	->	CILINDRO DE RODA ESQUERDA 19,05mm	1971/1978		<b>C-3395</b>	
OPALA	->	CILINDRO DE RODA DIREITA 19,05mm	1971/1978		<b>C-3396</b>	
OPALA	->	CILINDRO DE RODA ESQUERDA 19,05mm	1979/1980		<b>C-3468</b>	
OPALA	->	CILINDRO DE RODA DIREITA 19,05mm	1979/1980		<b>C-3469</b>	
OPALA	->	CILINDRO DE RODA ESQUERDA 22,22mm	1981/1982	SIST. BENDIX	<b>C-3446</b>	
OPALA	->	CILINDRO DE RODA DIREITA 22,22mm	1981/1982	SIST. BENDIX	<b>C-3447</b>	
OPALA	->	CILINDRO DE RODA ESQUERDA 22,22mm	1981/1992	SIST. VARGA	<b>C-3371</b>	
OPALA	->	CILINDRO DE RODA DIREITA 22,22mm	1981/1992	SIST. VARGA	<b>C-3372</b>	
OPALA	->	REPARO DO CILINDRO DE RODA 19,05mm	1971/1980	SIST. VARGA	<b>C-1481</b>	
OPALA	->	REPARO DO CILINDRO DE RODA 22,22mm	1981/1982	SIST. BENDIX	<b>C-1442</b>	
OPALA	->	REPARO DO CILINDRO DE RODA 22,22mm	1981/1992	SIST. VARGA	<b>C-1439</b>	
OPALA	->	COPO DO CILINDRO DE RODA 22,22mm	1969/1972	SIST. BENDIX	<b>CO-1315</b>	
OPALA	->	GAXETA DO CILINDRO DE RODA 19,05mm	1971/1980	SIST. VARGA	<b>GA-0307</b>	
OPALA	->	COPO DO CILINDRO DE RODA 22,22mm	1981/1982	SIST. BENDIX	<b>CO-1315</b>	
OPALA	->	GAXETA DO CILINDRO DE RODA 22,22mm	1981/1992	SIST. VARGA	<b>GA-0316</b>	
OPALA	->	TAPA-PÓ DO CILINDRO DE RODA	1969/1972	SIST. BENDIX	<b>TA-1300</b>	
OPALA	->	TAPA-PÓ DO CILINDRO DE RODA	1971/1992	SIST. VARGA	<b>TA-0312</b>	
OPALA	->	TAPA-PÓ DO CILINDRO DE RODA	1981/1982	SIST. BENDIX	<b>TA-0310</b>	
OPALA	->	REPARO DE VEDAÇÃO DA PINÇA 43,00mm	1991/1992		<b>C-1535</b>	
OPALA	->	TAPA PÓ DO PINO DE GUIA	1991/1992		<b>TA-0322</b>	

BUSCA POR VEÍCULOS

Tabela de Conversão	Polegadas	9/16"	5/8"	11/16"	7/10"	3/4"	13/16"	7/8"	15/16"	1"	1 1/16"	1 1/8"	1 1/4"	1 3/8"	1 1/2"	1 5/8"	1 3/4"	1 27/32"	2"
	Milímetros	14,28mm	15,87mm	17,46mm	17,78mm	19,05mm	20,63mm	22,22mm	23,81mm	25,40mm	26,98mm	28,57mm	31,75mm	34,92mm	38,10mm	41,27mm	44,45mm	46,83mm	50,80mm

VEÍCULO		DESCRIÇÃO	ANOS	OBSERVAÇÃO	REF.	IMAGEM
<b>GM - CHEVROLET</b>						
PRISMA		CIL. ATUADOR CONCÊNTRICO DE EMBREAGEM	2013/...	MOTOR 1.0 E 1.4	C-2709	
PRISMA		SERVO FREIO 200mm	2007/2012		C-5668	
PRISMA		CILINDRO MESTRE DUPLO 20,63mm	2007/2012		C-2168	
PRISMA		REPARO DO CILINDRO MESTRE DUPLO 20,63mm	2007/2012		C-1170	
PRISMA		RESERVATÓRIO C/ TAMPÃO E AVISO DE NÍVEL	2007/2012		C-0106	
PRISMA		VEDANTE DO CILINDRO MESTRE	2007/2012		VE-0204	
PRISMA	<	REPARO DE VEDAÇÃO DA PINÇA 48,00mm	2007/2012		C-1550	
PRISMA	->	CILINDRO DE RODA 14,28mm	2007/2012		C-3500	
PRISMA	->	CILINDRO DE RODA 19,05mm	2013/...		C-3426	
PRISMA	->	REPARO DO CILINDRO DE RODA 14,28mm	2007/2012		C-1519	
PRISMA	->	GAXETA DO CILINDRO DE RODA 14,28mm	2007/2012		GA-0311	
PRISMA	->	TAPA-PÓ DO CILINDRO DE RODA	2007/2012		TA-0338	
PRISMA		MANGUEIRA DO FILTRO DE AR	2007/2008		C-9008	
PRISMA		MANGUEIRA DO FILTRO DE AR	2009/2012	MOTOR 1.0	C-9018	
PRISMA		MANGUEIRA DO FILTRO DE AR	2009/2012	MOTOR 1.4	C-9019	
PRISMA		MANGUEIRA DO RESPIRO DO MOTOR	2007/2012		C-9017	
S-10		CILINDRO MESTRE DE EMBREAGEM 19,05mm	1995/2000	MOTOR 2.2 GASOLINA/2.5 DIESEL	C-2624	

Tabela de Conversão	Polegadas	9/16"	5/8"	11/16"	7/10"	3/4"	13/16"	7/8"	15/16"	1"	1 1/16"	1 1/8"	1 1/4"	1 3/8"	1 1/2"	1 5/8"	1 3/4"	1 27/32"	2"
	Milímetros	14,28mm	15,87mm	17,46mm	17,78mm	19,05mm	20,63mm	22,22mm	23,81mm	25,40mm	26,98mm	28,57mm	31,75mm	34,92mm	38,10mm	41,27mm	44,45mm	46,83mm	50,80mm

VEÍCULO		DESCRIÇÃO	ANOS	OBSERVAÇÃO	REF.	IMAGEM
<b>GM - CHEVROLET</b>						
S-10		CILINDRO MESTRE DE EMBREAGEM 19,05mm	1995/2000	MOTOR 4.3 V6	C-2646	
S-10		CILINDRO MESTRE DE EMBREAGEM 19,05mm	2001/2012	MOTOR 2.4 GASOLINA	C-2624	
S-10		CILINDRO MESTRE DE EMBREAGEM 19,05mm	2001/2012	MOTOR 4.3 V6/2.8 DIESEL	C-2646	
S-10		CILINDRO AUXILIAR DE EMBREAGEM 20,63mm	1995/2000	MOTOR 2.2 GASOLINA/2.5 DIESEL	C-2625	
S-10		CIL. ATUADOR CONCÊNTRICO DE EMBREAGEM	1995/2000	MOTOR 4.3 V6	C-2704	
S-10		CILINDRO AUXILIAR DE EMBREAGEM 20,63mm	2001/2012	MOTOR 2.4 GASOLINA	C-2625	
S-10		CIL. ATUADOR CONCÊNTRICO DE EMBREAGEM	2001/2012	MOTOR 4.3 V6/2.8 DIESEL	C-2704	
S-10		VÁLVULA DE RETENÇÃO DE VÁCUO	1995/2012		C-1755	
S-10		CILINDRO MESTRE DUPLO 25,40mm	1995/2012	S/ABS	C-2073	
S-10		CILINDRO MESTRE DUPLO 25,40mm	1995/2012	C/ABS NAS RODAS TRASEIRAS	C-2073	
S-10		REPARO DO CILINDRO MESTRE DUPLO 25,40mm	1995/2012	S/ABS	C-1133	
S-10		REPARO DO CILINDRO MESTRE DUPLO 25,40mm	1995/2012	C/ABS NAS RODAS TRASEIRAS	C-1133	
S-10		VEDANTE DO CILINDRO MESTRE	1995/2012		VE-0204	
S-10	<-	REPARO DE VEDAÇÃO DA PINÇA 66,00mm	1995/2012	C/ TRACÇÃO 4X2	C-1547	
S-10	<-	REPARO DE VEDAÇÃO DA PINÇA 47,00mm	1996/2012	C/ TRACÇÃO 4X4	C-1452	
S-10	->	CILINDRO DE RODA ESQUERDA 23,81mm	1995/2012	C/FREIO 280 X 63mm	C-3417	

BUSCA POR VEÍCULOS

150

Tabela de Conversão	Polegadas	9/16"	5/8"	11/16"	7/10"	3/4"	13/16"	7/8"	15/16"	1"	1 1/16"	1 1/8"	1 1/4"	1 3/8"	1 1/2"	1 5/8"	1 3/4"	1 27/32"	2"
	Milímetros	14,28mm	15,87mm	17,46mm	17,78mm	19,05mm	20,63mm	22,22mm	23,81mm	25,40mm	26,98mm	28,57mm	31,75mm	34,92mm	38,10mm	41,27mm	44,45mm	46,83mm	50,80mm

VEÍCULO		DESCRIÇÃO	ANOS	OBSERVAÇÃO	REF.	IMAGEM
<b>GM - CHEVROLET</b>						
S-10	->	CILINDRO DE RODA DIREITA 23,81mm	1995/2012	C/FREIO 280 X 63mm	C-3418	
S-10	->	CILINDRO DE RODA ESQUERDA 22,22mm	1997/2012	C/FREIO 280 X 51mm	C-3456	
S-10	->	CILINDRO DE RODA DIREITA 22,22mm	1997/2012	C/FREIO 280 X 51mm	C-3457	
S-10	->	REPARO DO CILINDRO DE RODA 23,81mm	1995/2012	C/FREIO 280 X 63mm	C-1405	
S-10	->	REPARO DO CILINDRO DE RODA 22,22mm	1997/2012	C/FREIO 280 X 51mm	C-1407	
S-10	->	COPO DO CILINDRO DE RODA 23,81mm	1995/2012	C/FREIO 280 X 63mm	CO-1311	
S-10	->	COPO DO CILINDRO DE RODA 22,22mm	1997/2012	C/FREIO 280 X 51mm	CO-1315	
S-10	->	TAPA-PÓ DO CILINDRO DE RODA	1995/2012		TA-0314	
S-10		MANGUEIRA DO FILTRO DE AR	1998/2000	MOTOR 2.2 MPFI	C-9027	
SILVERADO		CILINDRO MESTRE DE EMBREAGEM 19,05mm	1997/2001		C-2638	
SILVERADO		CILINDRO AUXILIAR DE EMBREAGEM 20,63mm	1997/2001		C-2627	
SILVERADO	<-	REPARO DE VEDAÇÃO DA PINÇA 54,00mm	1997/2001		C-1542	
SILVERADO	<-	TAPA-PÓ DO PINO DE GUIA	1997/2001		TA-1312	
SILVERADO	->	CILINDRO DE RODA ESQUERDA 23,81mm	1997/1999		C-3441	
SILVERADO	->	CILINDRO DE RODA DIREITA 23,81mm	1997/1999		C-3442	
SILVERADO	->	CILINDRO DE RODA ESQUERDA 28,57mm	1999/2001		C-3492	
SILVERADO	->	CILINDRO DE RODA DIREITA 28,57mm	1999/2001		C-3493	

Tabela de Conversão	Polegadas	9/16"	5/8"	11/16"	7/10"	3/4"	13/16"	7/8"	15/16"	1"	1 1/16"	1 1/8"	1 1/4"	1 3/8"	1 1/2"	1 5/8"	1 3/4"	1 27/32"	2"
	Milímetros	14,28mm	15,87mm	17,46mm	17,78mm	19,05mm	20,63mm	22,22mm	23,81mm	25,40mm	26,98mm	28,57mm	31,75mm	34,92mm	38,10mm	41,27mm	44,45mm	46,83mm	50,80mm

VEÍCULO		DESCRIÇÃO	ANOS	OBSERVAÇÃO	REF.	IMAGEM
<b>GM - CHEVROLET</b>						
SILVERADO	->	REPARO DO CILINDRO DE RODA 23,81mm	1997/1999		C-1405	
SILVERADO	->	REPARO DO CILINDRO DE RODA 28,57mm	1999/2001		C-1422	
SILVERADO	->	COPO DO CILINDRO DE RODA 23,81mm	1997/1999		CO-1311	
SILVERADO	->	COPO DO CILINDRO DE RODA 28,57mm	1999/2001		CO-1309	
SILVERADO	->	TAPA-PÓ DO CILINDRO DE RODA	1997/1999		TA-0314	
SILVERADO	->	TAPA-PÓ DO CILINDRO DE RODA	1999/2001		TA-0349	
SONIC	->	CILINDRO DE RODA 19,05mm	2012/2014		C-3426	
SPACE VAN		CILINDRO MESTRE DUPLO 23,81mm	1997/1999		C-2064	
SPACE VAN		REPARO DO CILINDRO MESTRE DUPLO 23,81mm	1997/1999		C-1164	
SPACE VAN		VEDANTE DO CILINDRO MESTRE	1997/1999		VE-0204	
SPACE VAN	->	CILINDRO DE RODA 23,81mm	1997/1999		C-3463	
SPACE VAN	->	REPARO DO CILINDRO DE RODA 23,81mm	1997/1999		C-1579	
SPACE VAN	->	GAXETA DO CILINDRO DE RODA 23,81mm	1997/1999		GA-0308	
SPACE VAN	->	TAPA-PÓ DO CILINDRO DE RODA	1997/1999		TA-0378	
SPIN		MANGUEIRA DO FILTRO DE AR	2013/...		C-9021	
SUPREMA		REPARO DO CILINDRO MESTRE DUPLO 22,22mm	1993/1997	4 CIL. S/ABS SIST. ATE	C-1122	
SUPREMA		REPARO DO CILINDRO MESTRE DUPLO 22,22mm	1993/1997	4 CIL. C/ABS	C-1123	
SUPREMA		REPARO DO CILINDRO MESTRE DUPLO 23,81mm	1993/1997	6 CIL. C/ABS E S/ABS	C-1124	
SUPREMA		REPARO DO CILINDRO MESTRE DUPLO 22,22mm	1993/1997	4 CIL. S/ABS SIST. VARGA	C-1134	
SUPREMA		RESERVATÓRIO C/ TAMPA E AVISO DE NÍVEL	1993/1997	4 CIL. S/ABS SIST. VARGA	C-0101	
SUPREMA		VEDANTE DO CILINDRO MESTRE	1993/1997	SIST. VARGA	VE-0200	
SUPREMA		VEDANTE DO CILINDRO MESTRE	1993/1997	SIST. ATE	VE-0204	
SUPREMA	<	REPARO DE VEDAÇÃO DA PINÇA 54,00mm	1993/1997	MOTOR 4 CIL.	C-1419	
SUPREMA	<	REPARO DE VEDAÇÃO DA PINÇA 57,00mm	1993/1997	MOTOR 6 CIL.	C-1538	
TIGRA		REPARO DO CILINDRO MESTRE DUPLO 20,63mm	1998/1999	S/ABS	C-1129	
TIGRA		VEDANTE DO CILINDRO MESTRE	1998/1999		VE-0206	
TIGRA	<	REPARO DE VEDAÇÃO DA PINÇA 48,00mm	1998/1999	SIST. ATE	C-1550	
TIGRA	->	CILINDRO DE RODA 19,05mm	1998/1999		C-3410	
TIGRA	->	REPARO DO CILINDRO DE RODA 19,05mm	1998/1999		C-1543	
TIGRA	->	GAXETA DO CILINDRO DE RODA 19,05mm	1998/1999		GA-0307	
TIGRA	->	TAPA-PÓ DO CILINDRO DE RODA	1998/1999		TA-0369	
TRACKER	->	CILINDRO DE RODA ESQUERDA 22,22mm	2000/2009		C-3532	

BUSCA POR VEÍCULOS

Tabela de Conversão	Polegadas	9/16"	5/8"	11/16"	7/10"	3/4"	13/16"	7/8"	15/16"	1"	1 1/16"	1 1/8"	1 1/4"	1 3/8"	1 1/2"	1 5/8"	1 3/4"	1 27/32"	2"
	Milímetros	14,28mm	15,87mm	17,46mm	17,78mm	19,05mm	20,63mm	22,22mm	23,81mm	25,40mm	26,98mm	28,57mm	31,75mm	34,92mm	38,10mm	41,27mm	44,45mm	46,83mm	50,80mm



VEÍCULO		DESCRIÇÃO	ANOS	OBSERVAÇÃO	REF.	IMAGEM
<b>GM - CHEVROLET</b>						
TRACKER	->	CILINDRO DE RODA DIREITA 22,22mm	2000/2009		C-3533	
TRAFIC		CILINDRO MESTRE DUPLO 23,81mm	1992/1998		C-2064	
TRAFIC		REPARO DO CILINDRO MESTRE DUPLO 23,81mm	1992/1998		C-1164	
TRAFIC		VEDANTE DO CILINDRO MESTRE	1992/1998		VE-0204	
TRAFIC	->	CILINDRO DE RODA 23,81mm	1992/1998		C-3463	
TRAFIC	->	REPARO DO CILINDRO DE RODA 23,81mm	1992/1998		C-1579	
TRAFIC	->	GAXETA DO CILINDRO DE RODA 23,81mm	1992/1998		GA-0308	
TRAFIC	->	TAPA-PÓ DO CILINDRO DE RODA	1992/1998		TA-0378	
VECTRA		CILINDRO MESTRE DE EMBREAGEM 15,87mm	1997/2005		C-2642	
VECTRA		CILINDRO MESTRE DE EMBREAGEM 15,87mm	2006/2011		C-2644	
VECTRA		CIL. ATUADOR CONCÊNTRICO DE EMBREAGEM	1997/2005	MOTOR 2.0/2.2 8V/16V (F-18)	C-2701	
VECTRA		CIL. ATUADOR CONCÊNTRICO DE EMBREAGEM	2000/2003	MOTOR 2.2 8V/16V (F-23)	C-2705	
VECTRA		CIL. ATUADOR CONCÊNTRICO DE EMBREAGEM	2004/2005	MOTOR 2.0 8V (F-17)	C-2709	
VECTRA		CIL. ATUADOR CONCÊNTRICO DE EMBREAGEM	2006/2011		C-2709	
VECTRA		SERVO FREIO 230mm	1994/1996	SIST. ATE	C-5632	
VECTRA		SERVO FREIO 230mm	1994/1996	SIST. DELCO CONVEXO	C-5642	

Tabela de Conversão	Polegadas	9/16"	5/8"	11/16"	7/10"	3/4"	13/16"	7/8"	15/16"	1"	1 1/16"	1 1/8"	1 1/4"	1 3/8"	1 1/2"	1 5/8"	1 3/4"	1 27/32"	2"
	Milímetros	14,28mm	15,87mm	17,46mm	17,78mm	19,05mm	20,63mm	22,22mm	23,81mm	25,40mm	26,98mm	28,57mm	31,75mm	34,92mm	38,10mm	41,27mm	44,45mm	46,83mm	50,80mm









VEÍCULO		DESCRIÇÃO	ANOS	OBSERVAÇÃO	REF.	IMAGEM
<b>GM - CHEVROLET</b>						
VECTRA		SERVO FREIO 230mm	1997/2001	MOTOR 2.0/2.2 8V	C-5639	
VECTRA		CILINDRO MESTRE DUPL0 22,22mm	1994/1996	SIST. ATE S/ABS	C-2083	
VECTRA		CILINDRO MESTRE DUPL0 22,22mm	1997/2001	MOTOR 2.0/2.2 8V ( EXCETO SIST. DELCO)	C-2071	
VECTRA		CILINDRO MESTRE DUPL0 23,81mm	1997/2001	MOTOR 2.0/2.2 16V	C-2098	
VECTRA		CILINDRO MESTRE DUPL0 23,81mm	2002/2005		C-2141	
VECTRA		CILINDRO MESTRE DUPL0 23,81mm	2006/2011		C-2097	
VECTRA		REPARO DO CILINDRO MESTRE DUPL0 22,22mm	1994/1996	SIST. ATE S/ABS	C-1140	
VECTRA		REPARO DO CILINDRO MESTRE DUPL0 22,22mm	1994/1996	SIST. DELCO CÔNCAVO S/ABS	C-1141	
VECTRA		REPARO DO CILINDRO MESTRE DUPL0 22,22mm	1994/1996	SIST. DELCO CONVEXO S/ABS	C-1154	
VECTRA		REPARO DO CILINDRO MESTRE DUPL0 22,22mm	1994/1996	SIST. ATE C/ABS	C-1160	
VECTRA		REPARO DO CILINDRO MESTRE DUPL0 22,22mm	1997/2001	MOTOR 2.0/2.2 8V, C/ CILINDRO DELCO	C-1139	
VECTRA		REPARO DO CILINDRO MESTRE DUPL0 22,22mm	1997/2001	MOTOR 2.0/2.2 8V	C-1151	
VECTRA		RESERVATÓRIO C/ TAMP A E AVISO DE NÍVEL	1994/1996	SIST. ATE	C-0106	
VECTRA		VEDANTE DO CILINDRO MESTRE	1994/1996	SIST. ATE	VE-0204	
VECTRA		VEDANTE DO CILINDRO MESTRE	1994/1996	SIST. DELCO	VE-0206	
VECTRA		VEDANTE DO CILINDRO MESTRE	1997/2005		VE-0206	
VECTRA		VEDANTE DO CILINDRO MESTRE	2006/2011		VE-0204	
VECTRA	<	REPARO DE VEDAÇÃO DA PINÇA 52,00mm	1994/1996		C-1565	
VECTRA	<	REPARO DE VEDAÇÃO DA PINÇA 52,00mm	1997/2001	MOTOR 2.0/2.2 8V	C-1565	
VECTRA	<	REPARO DE VEDAÇÃO DA PINÇA 57,00mm	1997/2001	MOTOR 2.0/2.2 16V	C-1567	
VECTRA	<	REPARO DE VEDAÇÃO DA PINÇA 54,00mm	2002/2011		C-1419	
VECTRA	>	CILINDRO DE RODA 19,05mm	1997/2005		C-3410	
VECTRA	>	CILINDRO DE RODA 19,05mm	2006/2011	S/ VÁLVULA PROPORCIONADORA	C-3410	

BUSCA POR VEÍCULOS

Tabela de Conversão	Polegadas	9/16"	5/8"	11/16"	7/10"	3/4"	13/16"	7/8"	15/16"	1"	1 1/16"	1 1/8"	1 1/4"	1 3/8"	1 1/2"	1 5/8"	1 3/4"	1 27/32"	2"
	Milímetros	14,28mm	15,87mm	17,46mm	17,78mm	19,05mm	20,63mm	22,22mm	23,81mm	25,40mm	26,98mm	28,57mm	31,75mm	34,92mm	38,10mm	41,27mm	44,45mm	46,83mm	50,80mm

VEÍCULO		DESCRIÇÃO	ANOS	OBSERVAÇÃO	REF.	IMAGEM
<b>GM - CHEVROLET</b>						
VECTRA	->	CILINDRO DE RODA 22,22mm	2006/2011	C/ VÁLVULA PROPORCIONADORA	C-3521	
VECTRA	->	REPARO DO CILINDRO DE RODA 19,05mm	1997/2005		C-1543	
VECTRA	->	REPARO DO CILINDRO DE RODA 22,22mm	2006/2011	C/ VÁLVULA PROPORCIONADORA	C-1531	
VECTRA	->	REPARO DO CILINDRO DE RODA 19,05mm	2006/2011	S/ VÁLVULA PROPORCIONADORA	C-1543	
VECTRA	->	GAXETA DO CILINDRO DE RODA 19,05mm	1997/2005		GA-0307	
VECTRA	->	COPO DO CILINDRO DE RODA 22,22mm	2006/2011	C/ VÁLVULA PROPORCIONADORA	CO-1315	
VECTRA	->	GAXETA DO CILINDRO DE RODA 19,05mm	2006/2011	S/ VÁLVULA PROPORCIONADORA	GA-0307	
VECTRA	->	TAPA-PÓ DO CILINDRO DE RODA	1997/2005		TA-0369	
VECTRA	->	TAPA-PÓ DO CILINDRO DE RODA	2006/2011	C/ VÁLVULA PROPORCIONADORA	TA-0321	
VECTRA	->	TAPA-PÓ DO CILINDRO DE RODA	2006/2011	S/ VÁLVULA PROPORCIONADORA	TA-0369	
VECTRA	->	REPARO DE VEDAÇÃO DA PINÇA 35,00mm	1994/2011		C-1541	
VECTRA		MANGUEIRA DO FILTRO DE AR	1997/2005	MOTOR 2.0/2.2 MPFI 8V	C-9013	
VERANEIO		CILINDRO MESTRE DE EMBREAGEM 22,22mm	1993/1996		C-2626	
VERANEIO		CILINDRO AUXILIAR DE EMBREAGEM 20,63mm	1993/1996		C-2627	
VERANEIO		SERVO FREIO 200mm	1979/1988		C-5618	
VERANEIO		VÁLVULA DE RETENÇÃO DE VÁCUO	1979/1988		C-1755	
VERANEIO		CILINDRO MESTRE DUPLA 25,40mm C/ RESERV.	1973/1978		C-2134	
VERANEIO		CILINDRO MESTRE DUPLA 25,40mm C/ RESERV.	1979/1988		C-2052	
VERANEIO		CILINDRO MESTRE DUPLA 28,57mm	1989/1992		C-2044	
VERANEIO		CILINDRO MESTRE DUPLA 28,57mm	1993/1996	EXCETO TURBO	C-2045	

Tabela de Conversão	Polegadas	9/16"	5/8"	11/16"	7/10"	3/4"	13/16"	7/8"	15/16"	1"	1 1/16"	1 1/8"	1 1/4"	1 3/8"	1 1/2"	1 5/8"	1 3/4"	1 27/32"	2"
	Milímetros	14,28mm	15,87mm	17,46mm	17,78mm	19,05mm	20,63mm	22,22mm	23,81mm	25,40mm	26,98mm	28,57mm	31,75mm	34,92mm	38,10mm	41,27mm	44,45mm	46,83mm	50,80mm

VEÍCULO		DESCRIÇÃO	ANOS	OBSERVAÇÃO	REF.	IMAGEM
<b>GM - CHEVROLET</b>						
VERANEIO		CILINDRO MESTRE DUPL0 28,57mm	1993/1996	MOTOR 4.0 TURBO	C-2088	
VERANEIO		REPARO DO CILINDRO MESTRE SIMPLES 25,40mm	1968/1973		C-1051	
VERANEIO		REPARO DO CILINDRO MESTRE DUPL0 25,40mm	1973/1976		C-1092	
VERANEIO		REPARO DO CILINDRO MESTRE DUPL0 25,40mm	1977/1978		C-1082	
VERANEIO		REPARO DO CILINDRO MESTRE DUPL0 25,40mm	1979/1988		C-1092	
VERANEIO		REPARO DO CILINDRO MESTRE DUPL0 28,57mm	1989/1992		C-1114	
VERANEIO		REPARO DO CILINDRO MESTRE DUPL0 28,57mm	1993/1996		C-1125	
VERANEIO		RESERVATÓRIO C/ TAMPA	1973/1988		C-0105	
VERANEIO		RESERVATÓRIO C/ TAMPA E AVISO DE NÍVEL	1989/1996		C-0109	
VERANEIO		VEDANTE DO CILINDRO MESTRE	1973/1996		VE-0203	
VERANEIO	<	CILINDRO DE RODA ESQUERDA 28,57mm	1968/1975		C-3421	
VERANEIO	<	CILINDRO DE RODA DIREITA 28,57mm	1968/1975		C-3422	
VERANEIO	<	CILINDRO DE RODA ESQUERDA 28,57mm	1975/1978		C-3419	
VERANEIO	<	CILINDRO DE RODA DIREITA 28,57mm	1975/1978		C-3420	
VERANEIO	<	REPARO DO CILINDRO DE RODA 28,57mm	1968/1978		C-1422	
VERANEIO	<	COPO DO CILINDRO DE RODA 28,57mm	1968/1978		CO-1309	
VERANEIO	<	TAPA-PÓ DO CILINDRO DE RODA	1968/1978		TA-0349	
VERANEIO	<	REPARO DE VEDAÇÃO DA PINÇA 79,00mm	1979/1992	(2 RODAS)	C-1500	
VERANEIO	<	REPARO DE VEDAÇÃO DA PINÇA 54,00mm	1993/1996		C-1542	
VERANEIO	<	TAPA-PÓ DO PINO DE GUIA	1993/1996		TA-1312	
VERANEIO	>	CILINDRO DE RODA ESQUERDA 25,40mm	1968/1978		C-3392	
VERANEIO	>	CILINDRO DE RODA DIREITA 25,40mm	1968/1978		C-3393	
VERANEIO	>	CILINDRO DE RODA ESQUERDA 25,40mm	1979/1992		C-3362	
VERANEIO	>	CILINDRO DE RODA DIREITA 25,40mm	1979/1992		C-3363	

BUSCA POR VEÍCULOS

Tabela de Conversão	Polegadas	9/16"	5/8"	11/16"	7/10"	3/4"	13/16"	7/8"	15/16"	1"	1 1/16"	1 1/8"	1 1/4"	1 3/8"	1 1/2"	1 5/8"	1 3/4"	1 27/32"	2"
	Milímetros	14,28mm	15,87mm	17,46mm	17,78mm	19,05mm	20,63mm	22,22mm	23,81mm	25,40mm	26,98mm	28,57mm	31,75mm	34,92mm	38,10mm	41,27mm	44,45mm	46,83mm	50,80mm

VEÍCULO		DESCRIÇÃO	ANOS	OBSERVAÇÃO	REF.	IMAGEM
<b>GM - CHEVROLET</b>						
VERANEIO	->	CILINDRO DE RODA ESQUERDA 23,81mm	1993/1996		C-3441	
VERANEIO	->	CILINDRO DE RODA DIREITA 23,81mm	1993/1996		C-3442	
VERANEIO	->	REPARO DO CILINDRO DE RODA 25,40mm	1968/1992		C-1416	
VERANEIO	->	REPARO DO CILINDRO DE RODA 23,81mm	1993/1996		C-1405	
VERANEIO	->	COPO DO CILINDRO DE RODA 25,40mm	1968/1992		CO-1307	
VERANEIO	->	COPO DO CILINDRO DE RODA 23,81mm	1993/1996		CO-1311	
VERANEIO	->	TAPA-PÓ DO CILINDRO DE RODA	1968/1996		TA-0314	
ZAFIRA		CILINDRO MESTRE DE EMBREAGEM 15,87mm	2002/2012		C-2668	
ZAFIRA		CIL. ATUADOR CONCÊNTRICO DE EMBREAGEM	2002/2003	MOTOR 2.0 16V (F-23)	C-2705	
ZAFIRA		CIL. ATUADOR CONCÊNTRICO DE EMBREAGEM	2002/2012	MOTOR 2.0 8V (F-17)	C-2709	
ZAFIRA		CIL. ATUADOR CONCÊNTRICO DE EMBREAGEM	2004/2012	MOTOR 2.0 16V (F-17)	C-2709	
ZAFIRA		CILINDRO MESTRE DUPLO 23,81mm	2002/2012		C-2097	
ZAFIRA		VEDANTE DO CILINDRO MESTRE	2002/2012		VE-0204	
ZAFIRA	<	REPARO DE VEDAÇÃO DA PINÇA 54,00mm	2002/2012	MOTOR 1.8/2.0 8V S/ABS	C-1419	
ZAFIRA	<	REPARO DE VEDAÇÃO DA PINÇA 57,00mm	2002/2012	MOTOR 2.0 16V	C-1567	
ZAFIRA	->	CILINDRO DE RODA 19,05mm	2002/2005		C-3410	
ZAFIRA	->	CILINDRO DE RODA 22,22mm	2005/2012		C-3521	
ZAFIRA	->	REPARO DO CILINDRO DE RODA 19,05mm	2002/2005		C-1543	
ZAFIRA	->	REPARO DO CILINDRO DE RODA 22,22mm	2005/2012		C-1531	
ZAFIRA	->	GAXETA DO CILINDRO DE RODA 19,05mm	2002/2005		GA-0307	
ZAFIRA	->	COPO DO CILINDRO DE RODA 22,22mm	2005/2012		CO-1315	

Tabela de Conversão	Polegadas	9/16"	5/8"	11/16"	7/10"	3/4"	13/16"	7/8"	15/16"	1"	1 1/16"	1 1/8"	1 1/4"	1 3/8"	1 1/2"	1 5/8"	1 3/4"	1 27/32"	2"
	Milímetros	14,28mm	15,87mm	17,46mm	17,78mm	19,05mm	20,63mm	22,22mm	23,81mm	25,40mm	26,98mm	28,57mm	31,75mm	34,92mm	38,10mm	41,27mm	44,45mm	46,83mm	50,80mm

VEÍCULO		DESCRIÇÃO	ANOS	OBSERVAÇÃO	REF.	IMAGEM
<b>GM - CHEVROLET</b>						
ZAFIRA	->	TAPA-PÓ DO CILINDRO DE RODA	2002/2005		TA-0369	
ZAFIRA	->	TAPA-PÓ DO CILINDRO DE RODA	2005/2012		TA-0321	
ZAFIRA	->	REPARO DE VEDAÇÃO DA PINÇA 35,00mm	2002/2012		C-1541	
<b>GM - CAMINHÕES</b>						
6500		REPARO DO HYDROVAC 9 1/2"	1964/1971		C-1213	
6500		REPARO DO CILINDRO MESTRE SIMPLES 31,75mm	1956/1971		C-1004	
6500	<-	REPARO DO CILINDRO DE RODA 22,22mm	1956/1971		C-1407	
6500	<-	COPO DO CILINDRO DE RODA 22,22mm	1956/1971		CO-1315	
6500	<-	TAPA-PÓ DO CILINDRO DE RODA	1956/1971		TA-0314	
6500	->	REPARO DO CILINDRO DE RODA 38,10mm	1956/1971		C-1423	
6500	->	GAXETA DO CILINDRO DE RODA 38,10mm	1956/1971		GA-0302	
6500	->	TAPA PÓ DO CILINDRO DE RODA	1956/1971		TA-0324	
C-60		REPARO DO HYDROVAC 9 1/2"	1964/1979		C-1213	
C-60		REPARO DO HYDROVAC 9 1/2"	1964/1981	ESCRAVO	C-1213	
C-60		REPARO DO HYDROVAC 10"	1980/1984	C/ 2 EIXOS	C-1201	
C-60		REPARO PARCIAL DO HYDROVAC 10"	1980/1984	C/ 2 EIXOS	C-1202	
C-60		DIAFRAGMA DO HYDROVAC 10"	1980/1984	C/ 2 EIXOS	DI-0500	
C-60		REPARO DO CILINDRO MESTRE SIMPLES 31,75mm	1964/1971		C-1004	
C-60		REPARO DO CILINDRO MESTRE SIMPLES 38,10mm	1972/1984		C-1067	
C-60	<-	CILINDRO DE RODA 25,40mm	1978/1979		C-3319	
C-60	<-	CILINDRO DE RODA ESQUERDA SUPERIOR 34,92mm	1980/1984		C-3320	
C-60	<-	CILINDRO DE RODA DIREITA SUPERIOR 34,92mm	1980/1984		C-3321	
C-60	<-	CILINDRO DE RODA ESQUERDA INFERIOR 34,92mm	1980/1984		C-3322	
C-60	<-	CILINDRO DE RODA DIREITA INFERIOR 34,92mm	1980/1984		C-3323	
C-60	<-	REPARO DO CILINDRO DE RODA 22,22mm	1964/1977		C-1407	
C-60	<-	REPARO DO CILINDRO DE RODA 25,40mm	1978/1979		C-1416	
C-60	<-	REPARO DO CILINDRO DE RODA 34,92mm	1980/1984		C-1401	
C-60	<-	COPO DO CILINDRO DE RODA 22,22mm	1964/1977		CO-1315	
C-60	<-	COPO DO CILINDRO DE RODA 25,40mm	1978/1979		CO-1307	
C-60	<-	GAXETA DO CILINDRO DE RODA 34,92mm	1980/1984		GA-0312	
C-60	<-	TAPA-PÓ DO CILINDRO DE RODA	1964/1979		TA-0314	
C-60	<-	TAPA-PÓ DO CILINDRO DE RODA	1980/1984		TA-0323	
C-60	->	CILINDRO DE RODA ESQUERDA SUPERIOR 41,27mm	1972/1979		C-3324	

Tabela de Conversão	Polegadas	9/16"	5/8"	11/16"	7/10"	3/4"	13/16"	7/8"	15/16"	1"	1 1/16"	1 1/8"	1 1/4"	1 3/8"	1 1/2"	1 5/8"	1 3/4"	1 27/32"	2"
	Milímetros	14,28mm	15,87mm	17,46mm	17,78mm	19,05mm	20,63mm	22,22mm	23,81mm	25,40mm	26,98mm	28,57mm	31,75mm	34,92mm	38,10mm	41,27mm	44,45mm	46,83mm	50,80mm

VEÍCULO		DESCRIÇÃO	ANOS	OBSERVAÇÃO	REF.	IMAGEM
<b>GM - CAMINHÕES</b>						
C-60	->	CILINDRO DE RODA DIREITA SUPERIOR 41,27mm	1972/1979		C-3325	
C-60	->	CILINDRO DE RODA ESQUERDA INFERIOR 41,27mm	1972/1979		C-3326	
C-60	->	CILINDRO DE RODA DIREITA INFERIOR 41,27mm	1972/1979		C-3327	
C-60	->	CILINDRO DE RODA ESQUERDA INFERIOR 44,45mm	1980/1984		C-3328	
C-60	->	CILINDRO DE RODA DIREITA INFERIOR 44,45mm	1980/1984		C-3329	
C-60	->	CILINDRO DE RODA ESQUERDA SUPERIOR 44,45mm	1980/1984		C-3330	
C-60	->	CILINDRO DE RODA DIREITA SUPERIOR 44,45mm	1980/1984		C-3331	
C-60	->	REPARO DO CILINDRO DE RODA 38,10mm	1964/1971		C-1423	
C-60	->	REPARO DO CILINDRO DE RODA 41,27mm	1964/1971	TERCEIRO EIXO	C-1485	
C-60	->	REPARO DO CILINDRO DE RODA 41,27mm	1964/1971	P/ CILINDRO VARGA TERCEIRO EIXO	C-1487	
C-60	->	REPARO DO CILINDRO DE RODA 41,27mm	1972/1979		C-1485	
C-60	->	REPARO DO CILINDRO DE RODA 41,27mm	1972/1979	P/ CILINDRO VARGA	C-1487	
C-60	->	REPARO DO CILINDRO DE RODA 44,45mm	1980/1984		C-1402	
C-60	->	COPO DO CILINDRO DE RODA 41,27mm	1964/1971	P/ CILINDRO VARGA TERCEIRO EIXO	CO-1316	
C-60	->	GAXETA DO CILINDRO DE RODA 41,27mm	1964/1971	TERCEIRO EIXO	GA-0300	
C-60	->	GAXETA DO CILINDRO DE RODA 38,10mm	1964/1971		GA-0302	
C-60	->	COPO DO CILINDRO DE RODA 41,27mm	1972/1979	P/ CILINDRO VARGA	CO-1316	
C-60	->	GAXETA DO CILINDRO DE RODA 41,27mm	1972/1979		GA-0300	
C-60	->	GAXETA DO CILINDRO DE RODA 44,45mm	1980/1984		GA-0313	
C-60	->	TAPA-PÓ DO CILINDRO DE RODA	1964/1971	TERCEIRO EIXO	TA-0323	
C-60	->	TAPA PÓ DO CILINDRO DE RODA	1964/1971		TA-0324	
C-60	->	TAPA-PÓ DO CILINDRO DE RODA	1972/1984		TA-0323	
D-40		CILINDRO MESTRE DE EMBREAGEM 22,22mm	1993/1997		C-2626	

Tabela de Conversão	Polegadas	9/16"	5/8"	11/16"	7/10"	3/4"	13/16"	7/8"	15/16"	1"	1 1/16"	1 1/8"	1 1/4"	1 3/8"	1 1/2"	1 5/8"	1 3/4"	1 27/32"	2"
	Milímetros	14,28mm	15,87mm	17,46mm	17,78mm	19,05mm	20,63mm	22,22mm	23,81mm	25,40mm	26,98mm	28,57mm	31,75mm	34,92mm	38,10mm	41,27mm	44,45mm	46,83mm	50,80mm

VEÍCULO		DESCRIÇÃO	ANOS	OBSERVAÇÃO	REF.	IMAGEM
<b>GM - CAMINHÕES</b>						
D-40		CILINDRO AUXILIAR DE EMBREAGEM 20,63mm	1993/1997		C-2627	
D-40		CILINDRO MESTRE DUPLO 28,57mm	1985/1997		C-2078	
D-40		REPARO DO CILINDRO MESTRE DUPLO 28,57mm	1985/1997		C-1050	
D-40		VEDANTE DO CILINDRO MESTRE	1985/1997		VE-0204	
D-40	<	REPARO DE VEDAÇÃO DA PINÇA 57,00mm	1985/1997		C-1521	
D-40	->	CILINDRO DE RODA ESQUERDA 31,75mm	1985/1997		C-3335	
D-40	->	CILINDRO DE RODA DIREITA 31,75mm	1985/1997		C-3336	
D-40	->	REPARO DO CILINDRO DE RODA 31,75mm	1985/1997		C-1412	
D-40	->	COPO DO CILINDRO DE RODA 31,75mm	1985/1997		CO-1300	
D-40	->	TAPA-PÓ DO CILINDRO DE RODA	1985/1997		TA-0350	
D-60 (11000/12000)		REPARO DO HYDROVAC 9 1/2"	1964/1979		C-1213	
D-60 (11000/12000)		REPARO DO HYDROVAC 9 1/2"	1964/1981	ESCRAVO	C-1213	
D-60 (11000/12000)		REPARO DO HYDROVAC 10"	1980/1996	C/ 2 EIXOS	C-1201	
D-60 (11000/12000)		REPARO PARCIAL DO HYDROVAC 10"	1980/1996	C/ 2 EIXOS	C-1202	
D-60 (11000/12000)		DIAFRAGMA DO HYDROVAC 10"	1980/1996	C/ 2 EIXOS	DI-0500	
D-60 (11000/12000)		REPARO DO CILINDRO MESTRE SIMPLES 31,75mm	1964/1971		C-1004	
D-60 (11000/12000)		REPARO DO CILINDRO MESTRE SIMPLES 38,10mm	1972/1984		C-1067	
D-60 (11000/12000)		REPARO DO CILINDRO MESTRE SIMPLES 38,10mm	1985/1996		C-1031	
D-60 (11000/12000)	<	CILINDRO DE RODA 25,40mm	1978/1979		C-3319	
D-60 (11000/12000)	<	CILINDRO DE RODA ESQUERDA SUPERIOR 34,92mm	1980/1996		C-3320	
D-60 (11000/12000)	<	CILINDRO DE RODA DIREITA SUPERIOR 34,92mm	1980/1996		C-3321	
D-60 (11000/12000)	<	CILINDRO DE RODA ESQUERDA INFERIOR 34,92mm	1980/1996		C-3322	

BUSCA POR VEÍCULOS

Tabela de Conversão	Polegadas	9/16"	5/8"	11/16"	7/10"	3/4"	13/16"	7/8"	15/16"	1"	1 1/16"	1 1/8"	1 1/4"	1 3/8"	1 1/2"	1 5/8"	1 3/4"	1 27/32"	2"
	Milímetros	14,28mm	15,87mm	17,46mm	17,78mm	19,05mm	20,63mm	22,22mm	23,81mm	25,40mm	26,98mm	28,57mm	31,75mm	34,92mm	38,10mm	41,27mm	44,45mm	46,83mm	50,80mm



VEÍCULO		DESCRIÇÃO	ANOS	OBSERVAÇÃO	REF.	IMAGEM
<b>GM - CAMINHÕES</b>						
D-60 (11000/12000)	<-	CILINDRO DE RODA DIREITA INFERIOR 34,92mm	1980/1996		C-3323	
D-60 (11000/12000)	<-	REPARO DO CILINDRO DE RODA 22,22mm	1964/1977		C-1407	
D-60 (11000/12000)	<-	REPARO DO CILINDRO DE RODA 25,40mm	1978/1979		C-1416	
D-60 (11000/12000)	<-	REPARO DO CILINDRO DE RODA 34,92mm	1980/1996		C-1401	
D-60 (11000/12000)	<-	COPO DO CILINDRO DE RODA 22,22mm	1964/1977		CO-1315	
D-60 (11000/12000)	<-	COPO DO CILINDRO DE RODA 25,40mm	1978/1979		CO-1307	
D-60 (11000/12000)	<-	GAXETA DO CILINDRO DE RODA 34,92mm	1980/1996		GA-0312	
D-60 (11000/12000)	<-	TAPA-PÓ DO CILINDRO DE RODA	1964/1979		TA-0314	
D-60 (11000/12000)	<-	TAPA-PÓ DO CILINDRO DE RODA	1980/1996		TA-0323	
D-60 (11000/12000)	->	CILINDRO DE RODA ESQUERDA SUPERIOR 41,27mm	1972/1979		C-3324	
D-60 (11000/12000)	->	CILINDRO DE RODA DIREITA SUPERIOR 41,27mm	1972/1979		C-3325	
D-60 (11000/12000)	->	CILINDRO DE RODA ESQUERDA INFERIOR 41,27mm	1972/1979		C-3326	
D-60 (11000/12000)	->	CILINDRO DE RODA DIREITA INFERIOR 41,27mm	1972/1979		C-3327	
D-60 (11000/12000)	->	CILINDRO DE RODA ESQUERDA INFERIOR 44,45mm	1980/1996		C-3328	
D-60 (11000/12000)	->	CILINDRO DE RODA DIREITA INFERIOR 44,45mm	1980/1996		C-3329	
D-60 (11000/12000)	->	CILINDRO DE RODA ESQUERDA SUPERIOR 44,45mm	1980/1996		C-3330	
D-60 (11000/12000)	->	CILINDRO DE RODA DIREITA SUPERIOR 44,45mm	1980/1996		C-3331	
D-60 (11000/12000)	->	REPARO DO CILINDRO DE RODA 38,10mm	1964/1971		C-1423	
D-60 (11000/12000)	->	REPARO DO CILINDRO DE RODA 41,27mm	1964/1971	TERCEIRO EIXO	C-1485	
D-60 (11000/12000)	->	REPARO DO CILINDRO DE RODA 41,27mm	1964/1971	P/ CILINDRO VARGA TERCEIRO EIXO	C-1487	
D-60 (11000/12000)	->	REPARO DO CILINDRO DE RODA 41,27mm	1972/1979		C-1485	

Tabela de Conversão	Polegadas	9/16"	5/8"	11/16"	7/10"	3/4"	13/16"	7/8"	15/16"	1"	1 1/16"	1 1/8"	1 1/4"	1 3/8"	1 1/2"	1 5/8"	1 3/4"	1 27/32"	2"
	Milímetros	14,28mm	15,87mm	17,46mm	17,78mm	19,05mm	20,63mm	22,22mm	23,81mm	25,40mm	26,98mm	28,57mm	31,75mm	34,92mm	38,10mm	41,27mm	44,45mm	46,83mm	50,80mm

VEÍCULO		DESCRIÇÃO	ANOS	OBSERVAÇÃO	REF.	IMAGEM
<b>GM - CAMINHÕES</b>						
D-60 (11000/12000)	->	REPARO DO CILINDRO DE RODA 41,27mm	1972/1979	P/ CILINDRO VARGA	C-1487	
D-60 (11000/12000)	->	REPARO DO CILINDRO DE RODA 44,45mm	1980/1996		C-1402	
D-60 (11000/12000)	->	COPO DO CILINDRO DE RODA 41,27mm	1964/1971	P/ CILINDRO VARGA TERCEIRO EIXO	CO-1316	
D-60 (11000/12000)	->	GAXETA DO CILINDRO DE RODA 41,27mm	1964/1971	TERCEIRO EIXO	GA-0300	
D-60 (11000/12000)	->	GAXETA DO CILINDRO DE RODA 38,10mm	1964/1971		GA-0302	
D-60 (11000/12000)	->	COPO DO CILINDRO DE RODA 41,27mm	1972/1979	P/ CILINDRO VARGA	CO-1316	
D-60 (11000/12000)	->	GAXETA DO CILINDRO DE RODA 41,27mm	1972/1979		GA-0300	
D-60 (11000/12000)	->	GAXETA DO CILINDRO DE RODA 44,45mm	1980/1996		GA-0313	
D-60 (11000/12000)	->	TAPA-PÓ DO CILINDRO DE RODA	1964/1971	TERCEIRO EIXO	TA-0323	
D-60 (11000/12000)	->	TAPA-PÓ DO CILINDRO DE RODA	1964/1971		TA-0324	
D-60 (11000/12000)	->	TAPA-PÓ DO CILINDRO DE RODA	1972/1996		TA-0323	
D-80 (19000)		DIAFRAGMA DO HYDROVAC 10"	1982/1984		DI-0500	
D-80 (19000)		REPARO DO CILINDRO MESTRE SIMPLES 38,10mm	1982/1984		C-1067	
D-80 (19000)	<-	CILINDRO DE RODA ESQUERDA SUPERIOR 34,92mm	1982/1984		C-3320	
D-80 (19000)	<-	CILINDRO DE RODA DIREITA SUPERIOR 34,92mm	1982/1984		C-3321	
D-80 (19000)	<-	CILINDRO DE RODA ESQUERDA INFERIOR 34,92mm	1982/1984		C-3322	
D-80 (19000)	<-	CILINDRO DE RODA DIREITA INFERIOR 34,92mm	1982/1984		C-3323	
D-80 (19000)	<-	REPARO DO CILINDRO DE RODA 34,92mm	1982/1984		C-1401	
D-80 (19000)	<-	GAXETA DO CILINDRO DE RODA 34,92mm	1982/1984		GA-0312	
D-80 (19000)	<-	TAPA-PÓ DO CILINDRO DE RODA	1982/1984		TA-0323	
D-80 (19000)	->	CILINDRO DE RODA ESQUERDA INFERIOR 44,45mm	1982/1984		C-3328	
D-80 (19000)	->	CILINDRO DE RODA DIREITA INFERIOR 44,45mm	1982/1984		C-3329	
D-80 (19000)	->	CILINDRO DE RODA ESQUERDA SUPERIOR 44,45mm	1982/1984		C-3330	
D-80 (19000)	->	CILINDRO DE RODA DIREITA SUPERIOR 44,45mm	1982/1984		C-3331	
D-80 (19000)	->	REPARO DO CILINDRO DE RODA 44,45mm	1982/1984		C-1402	

BUSCA POR VEÍCULOS

Tabela de Conversão	Polegadas	9/16"	5/8"	11/16"	7/10"	3/4"	13/16"	7/8"	15/16"	1"	1 1/16"	1 1/8"	1 1/4"	1 3/8"	1 1/2"	1 5/8"	1 3/4"	1 27/32"	2"
	Milímetros	14,28mm	15,87mm	17,46mm	17,78mm	19,05mm	20,63mm	22,22mm	23,81mm	25,40mm	26,98mm	28,57mm	31,75mm	34,92mm	38,10mm	41,27mm	44,45mm	46,83mm	50,80mm

VEÍCULO		DESCRIÇÃO	ANOS	OBSERVAÇÃO	REF.	IMAGEM
<b>GM - CAMINHÕES</b>						
D-80 (19000)	->	GAXETA DO CILINDRO DE RODA 44,45mm	1982/1984		GA-0313	
D-80 (19000)	->	TAPA-PÓ DO CILINDRO DE RODA	1982/1984		TA-0323	
<b>GMC</b>						
3500 HD		CILINDRO MESTRE DE EMBREAGEM 19,05mm	1997/2002		C-2638	
3500 HD		CILINDRO AUXILIAR DE EMBREAGEM 20,63mm	1997/2002		C-2627	
3500 HD	<-	REPARO DE VEDAÇÃO DA PINÇA 54,00mm	1997/2002		C-1542	
3500 HD	<-	TAPA-PÓ DO PINO DE GUIA	1997/2002		TA-1312	
3500 HD	->	CILINDRO DE RODA ESQUERDA 23,81mm	1997/1999		C-3441	
3500 HD	->	CILINDRO DE RODA DIREITA 23,81mm	1997/1999		C-3442	
3500 HD	->	CILINDRO DE RODA ESQUERDA 28,57mm	1999/2002		C-3492	
3500 HD	->	CILINDRO DE RODA DIREITA 28,57mm	1999/2002		C-3493	
3500 HD	->	REPARO DO CILINDRO DE RODA 23,81mm	1997/1999		C-1405	
3500 HD	->	REPARO DO CILINDRO DE RODA 28,57mm	1999/2002		C-1422	
3500 HD	->	COPO DO CILINDRO DE RODA 23,81mm	1997/1999		CO-1311	
3500 HD	->	COPO DO CILINDRO DE RODA 28,57mm	1999/2002		CO-1309	
3500 HD	->	TAPA-PÓ DO CILINDRO DE RODA	1997/1999		TA-0314	
3500 HD	->	TAPA-PÓ DO CILINDRO DE RODA	1999/2002		TA-0349	
6-100		CILINDRO MESTRE DE EMBREAGEM 19,05mm	1998/2002		C-2638	
6-100		CILINDRO AUXILIAR DE EMBREAGEM 20,63mm	1998/2002		C-2627	
6-100	<-	REPARO DE VEDAÇÃO DA PINÇA 57,00mm	1998/2002		C-1521	
6-100	->	CILINDRO DE RODA ESQUERDA 31,75mm	1998/2002		C-3335	

Tabela de Conversão	Polegadas	9/16"	5/8"	11/16"	7/10"	3/4"	13/16"	7/8"	15/16"	1"	1 1/16"	1 1/8"	1 1/4"	1 3/8"	1 1/2"	1 5/8"	1 3/4"	1 27/32"	2"
	Milímetros	14,28mm	15,87mm	17,46mm	17,78mm	19,05mm	20,63mm	22,22mm	23,81mm	25,40mm	26,98mm	28,57mm	31,75mm	34,92mm	38,10mm	41,27mm	44,45mm	46,83mm	50,80mm

VEÍCULO		DESCRIÇÃO	ANOS	OBSERVAÇÃO	REF.	IMAGEM
<b>GMC</b>						
6-100	->	CILINDRO DE RODA DIREITA 31,75mm	1998/2002		C-3336	
6-100	->	REPARO DO CILINDRO DE RODA 31,75mm	1998/2002		C-1412	
6-100	->	COPO DO CILINDRO DE RODA 31,75mm	1998/2002		CO-1300	
6-100	->	TAPA-PÓ DO CILINDRO DE RODA	1998/2002		TA-0350	
6-150		CILINDRO MESTRE DE EMBREAGEM 19,05mm	1998/2002		C-2638	
6-150		CILINDRO AUXILIAR DE EMBREAGEM 20,63mm	1998/2002		C-2627	
6-150	<-	REPARO DE VEDAÇÃO DA PINÇA 57,00mm	1998/2002		C-1521	
6-150	->	CILINDRO DE RODA ESQUERDA 31,75mm	1998/2002		C-3335	
6-150	->	CILINDRO DE RODA DIREITA 31,75mm	1998/2002		C-3336	
6-150	->	REPARO DO CILINDRO DE RODA 31,75mm	1998/2002		C-1412	
6-150	->	COPO DO CILINDRO DE RODA 31,75mm	1998/2002		CO-1300	
6-150	->	TAPA-PÓ DO CILINDRO DE RODA	1998/2002		TA-0350	
<b>GURGEL</b>						
BR-800/SUPERMINI		CILINDRO MESTRE DUPLO 19,05mm	1989/1993		C-2030	
BR-800/SUPERMINI		REPARO DO CILINDRO MESTRE DUPLO 19,05mm	1989/1993		C-1098	
BR-800/SUPERMINI		VEDANTE DO CILINDRO MESTRE	1989/1993		VE-0204	
BR-800/SUPERMINI	<-	REPARO DE VEDAÇÃO DA PINÇA 44,00mm	1989/1993		C-1493	
BR-800/SUPERMINI	->	REPARO DO CILINDRO DE RODA 19,05mm	1989/1993		C-1415	
BR-800/SUPERMINI	->	GAXETA DO CILINDRO DE RODA 19,05mm	1989/1993		GA-0307	
BR-800/SUPERMINI	->	TAPA-PÓ DO CILINDRO DE RODA	1989/1993		TA-0303	
E-400		CILINDRO MESTRE SIMPLES 22,22mm	1981/1983		C-2084	
E-400		REPARO DO CILINDRO MESTRE SIMPLES 22,22mm	1981/1983		C-1049	
E-400	<-	CILINDRO DE RODA ESQUERDA SUPERIOR 25,40mm	1981/1983		C-3399	

BUSCA POR VEÍCULOS

Tabela de Conversão	Polegadas	9/16"	5/8"	11/16"	7/10"	3/4"	13/16"	7/8"	15/16"	1"	1 1/16"	1 1/8"	1 1/4"	1 3/8"	1 1/2"	1 5/8"	1 3/4"	1 27/32"	2"
	Milímetros	14,28mm	15,87mm	17,46mm	17,78mm	19,05mm	20,63mm	22,22mm	23,81mm	25,40mm	26,98mm	28,57mm	31,75mm	34,92mm	38,10mm	41,27mm	44,45mm	46,83mm	50,80mm

VEÍCULO		DESCRIÇÃO	ANOS	OBSERVAÇÃO	REF.	IMAGEM
<b>GURGEL</b>						
E-400	<	CILINDRO DE RODA DIREITA SUPERIOR 25,40mm	1981/1983		C-3400	
E-400	<	CILINDRO DE RODA ESQUERDA INFERIOR 25,40mm	1981/1983		C-3401	
E-400	<	CILINDRO DE RODA DIREITA INFERIOR 25,40mm	1981/1983		C-3402	
E-400	<	REPARO DO CILINDRO DE RODA 25,40mm	1981/1983		C-1477	
E-400	<	GAXETA DO CILINDRO DE RODA 25,40mm	1981/1983		GA-0303	
E-400	<	TAPA PÓ DO CILINDRO DE RODA	1981/1983		TA-0331	
E-400	>	CILINDRO DE RODA 22,22mm	1981/1983		C-3403	
E-400	>	REPARO DO CILINDRO DE RODA 22,22mm	1981/1983		C-1476	
E-400	>	GAXETA DO CILINDRO DE RODA 22,22mm	1981/1983		GA-0314	
E-400	>	TAPA PÓ DO CILINDRO DE RODA	1981/1983		TA-0332	
G-15		SERVO FREIO 200mm	1980/1984		C-5607	
G-15		VÁLVULA DE RETENÇÃO DE VÁCUO	1980/1984		C-1753	
G-15		CILINDRO MESTRE SIMPLES 23,81mm	1980/1981		C-2017	
G-15		CILINDRO MESTRE DUPLO 23,81mm	1982/1984		C-2018	
G-15		REPARO DO CILINDRO MESTRE SIMPLES 23,81mm	1980/1981		C-1079	
G-15		REPARO DO CILINDRO MESTRE DUPLO 23,81mm	1982/1984		C-1021	
G-15		VEDANTE DO CILINDRO MESTRE	1980/1984		VE-0201	
G-15	<	CILINDRO DE RODA ESQUERDA SUPERIOR 25,40mm	1980/1981		C-3399	
G-15	<	CILINDRO DE RODA DIREITA SUPERIOR 25,40mm	1980/1981		C-3400	

Tabela de Conversão	Polegadas	9/16"	5/8"	11/16"	7/10"	3/4"	13/16"	7/8"	15/16"	1"	1 1/16"	1 1/8"	1 1/4"	1 3/8"	1 1/2"	1 5/8"	1 3/4"	1 27/32"	2"
	Milímetros	14,28mm	15,87mm	17,46mm	17,78mm	19,05mm	20,63mm	22,22mm	23,81mm	25,40mm	26,98mm	28,57mm	31,75mm	34,92mm	38,10mm	41,27mm	44,45mm	46,83mm	50,80mm

VEÍCULO		DESCRIÇÃO	ANOS	OBSERVAÇÃO	REF.	IMAGEM
<b>GURGEL</b>						
G-15	<	CILINDRO DE RODA ESQUERDA INFERIOR 25,40mm	1980/1981		C-3401	
G-15	<	CILINDRO DE RODA DIREITA INFERIOR 25,40mm	1980/1981		C-3402	
G-15	<	REPARO DO CILINDRO DE RODA 25,40mm	1980/1981		C-1477	
G-15	<	GAXETA DO CILINDRO DE RODA 25,40mm	1980/1981		GA-0303	
G-15	<	TAPA PÓ DO CILINDRO DE RODA	1980/1981		TA-0331	
G-15	<	REPARO DE VEDAÇÃO DA PINÇA 54,00mm	1982/1984		C-1430	
G-15	>	CILINDRO DE RODA 23,81mm	1980/1981		C-3367	
G-15	>	CILINDRO DE RODA 23,81mm	1983/1984		C-3366	
G-15	>	REPARO DO CILINDRO DE RODA 23,81mm	1980/1981		C-1495	
G-15	>	REPARO DO CILINDRO DE RODA 23,81mm	1983/1984		C-1445	
G-15	>	GAXETA DO CILINDRO DE RODA 23,81mm	1980/1981		GA-0308	
G-15	>	GAXETA DO CILINDRO DE RODA 23,81mm	1983/1984		GA-0308	
G-15	>	TAPA PÓ DO CILINDRO DE RODA	1980/1981		TA-0332	
G-800 CS/CD		SERVO FREIO 200mm	1983/1991		C-5607	
G-800 CS/CD		VÁLVULA DE RETENÇÃO DE VÁCUO	1983/1991		C-1753	
G-800 CS/CD		CILINDRO MESTRE SIMPLES 23,81mm	1983/1983		C-2017	
G-800 CS/CD		CILINDRO MESTRE DUPLA 23,81mm	1983/1991		C-2018	
G-800 CS/CD		REPARO DO CILINDRO MESTRE SIMPLES 23,81mm	1983/1983		C-1079	
G-800 CS/CD		REPARO DO CILINDRO MESTRE DUPLA 23,81mm	1983/1991		C-1021	
G-800 CS/CD		VEDANTE DO CILINDRO MESTRE	1983/1991		VE-0201	
G-800 CS/CD	<	REPARO DE VEDAÇÃO DA PINÇA 54,00mm	1983/1991		C-1430	
G-800 CS/CD	>	CILINDRO DE RODA 23,81mm	1983/1991		C-3366	
G-800 CS/CD	>	REPARO DO CILINDRO DE RODA 23,81mm	1983/1991		C-1445	
G-800 CS/CD	>	GAXETA DO CILINDRO DE RODA 23,81mm	1983/1991		GA-0308	

BUSCA POR VEÍCULOS

Tabela de Conversão	Polegadas	9/16"	5/8"	11/16"	7/10"	3/4"	13/16"	7/8"	15/16"	1"	1 1/16"	1 1/8"	1 1/4"	1 3/8"	1 1/2"	1 5/8"	1 3/4"	1 27/32"	2"
	Milímetros	14,28mm	15,87mm	17,46mm	17,78mm	19,05mm	20,63mm	22,22mm	23,81mm	25,40mm	26,98mm	28,57mm	31,75mm	34,92mm	38,10mm	41,27mm	44,45mm	46,83mm	50,80mm

VEÍCULO		DESCRIÇÃO	ANOS	OBSERVAÇÃO	REF.	IMAGEM
<b>GURGEL</b>						
X-12/TOCANTINS		CILINDRO MESTRE SIMPLES 17,46mm	1969/1977		C-2003	
X-12/TOCANTINS		CILINDRO MESTRE DUPL0 19,05mm	1978/1993		C-2007	
X-12/TOCANTINS		REPARO DO CILINDRO MESTRE SIMPLES 17,46mm	1969/1977		C-1048	
X-12/TOCANTINS		REPARO DO CILINDRO MESTRE DUPL0 19,05mm	1978/1993		C-1060	
X-12/TOCANTINS		VEDANTE DO CILINDRO MESTRE	1969/1993		VE-0201	
X-12/TOCANTINS	<	CILINDRO DE RODA 22,22mm	1969/1980		C-3351	
X-12/TOCANTINS	<	REPARO DO CILINDRO DE RODA 22,22mm	1969/1977	P/ CILINDRO VARGA RCCR 2157.8	C-1472	
X-12/TOCANTINS	<	REPARO DO CILINDRO DE RODA 22,22mm	1969/1980		C-1496	
X-12/TOCANTINS	<	COPO DO CILINDRO DE RODA 22,22mm	1969/1980		CO-1315	
X-12/TOCANTINS	<	TAPA PÓ DO CILINDRO DE RODA	1969/1977	P/ CILINDRO VARGA RCCR 2157.8	TA-0330	
X-12/TOCANTINS	<	TAPA PÓ DO CILINDRO DE RODA	1969/1980		TA-0336	
X-12/TOCANTINS	<	REPARO DE VEDAÇÃO DA PINÇA 40,00mm	1981/1993		C-1498	
X-12/TOCANTINS	>	CILINDRO DE RODA 17,46mm	1969/1980		C-3375	
X-12/TOCANTINS	>	CILINDRO DE RODA 22,22mm	1981/1993		C-3357	
X-12/TOCANTINS	>	REPARO DO CILINDRO DE RODA 17,46mm	1969/1980		C-1475	
X-12/TOCANTINS	>	REPARO DO CILINDRO DE RODA 22,22mm	1981/1993		C-1496	
X-12/TOCANTINS	>	COPO DO CILINDRO DE RODA 17,46mm	1969/1980		CO-1305	
X-12/TOCANTINS	>	COPO DO CILINDRO DE RODA 22,22mm	1981/1993		CO-1315	
X-12/TOCANTINS	>	TAPA PÓ DO CILINDRO DE RODA	1969/1980		TA-0329	
X-12/TOCANTINS	>	TAPA PÓ DO CILINDRO DE RODA	1981/1993		TA-0336	
X-15/CARAJÁS		SERVO FREIO 200mm	1985/1993		C-5607	
X-15/CARAJÁS		VÁLVULA DE RETENÇÃO DE VÁCUO	1985/1993		C-1753	
X-15/CARAJÁS		CILINDRO MESTRE DUPL0 23,81mm	1985/1993		C-2018	
X-15/CARAJÁS		REPARO DO CILINDRO MESTRE DUPL0 23,81mm	1985/1993		C-1021	
X-15/CARAJÁS		VEDANTE DO CILINDRO MESTRE	1985/1993		VE-0201	
X-15/CARAJÁS	<	REPARO DE VEDAÇÃO DA PINÇA 54,00mm	1985/1993		C-1430	
X-15/CARAJÁS	>	CILINDRO DE RODA 23,81mm	1985/1993		C-3366	
X-15/CARAJÁS	>	REPARO DO CILINDRO DE RODA 23,81mm	1985/1993		C-1445	
X-15/CARAJÁS	>	GAXETA DO CILINDRO DE RODA 23,81mm	1985/1993		GA-0308	

Conversão	Polegadas	9/16"	5/8"	11/16"	7/10"	3/4"	13/16"	7/8"	15/16"	1"	1 1/16"	1 1/8"	1 1/4"	1 3/8"	1 1/2"	1 5/8"	1 3/4"	1 27/32"	2"
Milímetros		14,28mm	15,87mm	17,46mm	17,78mm	19,05mm	20,63mm	22,22mm	23,81mm	25,40mm	26,98mm	28,57mm	31,75mm	34,92mm	38,10mm	41,27mm	44,45mm	46,83mm	50,80mm

VEÍCULO		DESCRIÇÃO	ANOS	OBSERVAÇÃO	REF.	IMAGEM
<b>GURGEL</b>						
X-20		CILINDRO MESTRE SIMPLES 22,22mm	1977/1979		C-2084	
X-20		REPARO DO CILINDRO MESTRE SIMPLES 22,22mm	1977/1979		C-1049	
X-20	<	CILINDRO DE RODA ESQUERDA SUPERIOR 25,40mm	1977/1979		C-3399	
X-20	<	CILINDRO DE RODA DIREITA SUPERIOR 25,40mm	1977/1979		C-3400	
X-20	<	CILINDRO DE RODA ESQUERDA INFERIOR 25,40mm	1977/1979		C-3401	
X-20	<	CILINDRO DE RODA DIREITA INFERIOR 25,40mm	1977/1979		C-3402	
X-20	<	REPARO DO CILINDRO DE RODA 25,40mm	1977/1979		C-1477	
X-20	<	GAXETA DO CILINDRO DE RODA 25,40mm	1977/1979		GA-0303	
X-20	<	TAPA PÓ DO CILINDRO DE RODA	1977/1979		TA-0331	
X-20	->	CILINDRO DE RODA 22,22mm	1977/1979		C-3403	
X-20	->	REPARO DO CILINDRO DE RODA 22,22mm	1977/1979		C-1476	
X-20	->	GAXETA DO CILINDRO DE RODA 22,22mm	1977/1979		GA-0314	
X-20	->	TAPA PÓ DO CILINDRO DE RODA	1977/1979		TA-0332	
XEF		CILINDRO MESTRE DUPLA 19,05mm	1984/1986		C-2007	
XEF		REPARO DO CILINDRO MESTRE DUPLA 19,05mm	1984/1986		C-1060	
XEF		VEDANTE DO CILINDRO MESTRE	1984/1986		VE-0201	
XEF	<	REPARO DE VEDAÇÃO DA PINÇA 40,00mm	1984/1986		C-1498	
XEF	->	CILINDRO DE RODA 22,22mm	1984/1986		C-3357	
XEF	->	REPARO DO CILINDRO DE RODA 22,22mm	1984/1986		C-1496	
XEF	->	COPO DO CILINDRO DE RODA 22,22mm	1984/1986		CO-1315	
XEF	->	TAPA PÓ DO CILINDRO DE RODA	1984/1986		TA-0336	
<b>HONDA</b>						
ACCORD	->	CILINDRO DE RODA ESQUERDA 19,05mm	1991/1993		C-3481	

BUSCA POR VEÍCULOS

Tabela de Conversão	Polegadas	9/16"	5/8"	11/16"	7/10"	3/4"	13/16"	7/8"	15/16"	1"	1 1/16"	1 1/8"	1 1/4"	1 3/8"	1 1/2"	1 5/8"	1 3/4"	1 27/32"	2"
	Milímetros	14,28mm	15,87mm	17,46mm	17,78mm	19,05mm	20,63mm	22,22mm	23,81mm	25,40mm	26,98mm	28,57mm	31,75mm	34,92mm	38,10mm	41,27mm	44,45mm	46,83mm	50,80mm



VEÍCULO		DESCRIÇÃO	ANOS	OBSERVAÇÃO	REF.	IMAGEM
<b>HONDA</b>						
ACCORD	->	CILINDRO DE RODA DIREITA 19,05mm	1991/1993		C-3482	
ACCORD	->	REPARO DO CILINDRO DE RODA 19,05mm	1991/1993		C-1594	
ACCORD	->	GAXETA DO CILINDRO DE RODA 19,05mm	1991/1993		GA-0307	
ACCORD	->	TAPA-PÓ DO CILINDRO DE RODA	1991/1993		TA-0303	
CITY	->	CILINDRO DE RODA 19,05mm	2010/...		C-3416	
CIVIC		CILINDRO MESTRE DE EMBREAGEM 15,87mm	1996/2000		C-2674	
CIVIC		CILINDRO AUXILIAR DE EMBREAGEM 19,05mm	1992/2000		C-2677	
CIVIC		CILINDRO MESTRE DUPLA 20,63mm	1998/2000	S/ABS	C-2180	
CIVIC		CILINDRO MESTRE DUPLA 22,22mm	2001/2006		C-2170	
CIVIC	<-	REPARO DE VEDAÇÃO DA PINÇA 54,00mm	1997/2000	SIST. VARGA	C-1568	
CIVIC	->	CILINDRO DE RODA ESQUERDA 19,05mm	1992/2000		C-3481	
CIVIC	->	CILINDRO DE RODA DIREITA 19,05mm	1992/2000		C-3482	
CIVIC	->	CILINDRO DE RODA ESQUERDA 19,05mm	2001/2006		C-3513	
CIVIC	->	CILINDRO DE RODA DIREITA 19,05mm	2001/2006		C-3514	
CIVIC	->	REPARO DO CILINDRO DE RODA 19,05mm	1992/2000		C-1594	
CIVIC	->	REPARO DO CILINDRO DE RODA 19,05mm	2001/2006		C-1481	
CIVIC	->	GAXETA DO CILINDRO DE RODA 19,05mm	1992/2006		GA-0307	

Tabela de Conversão	Polegadas	9/16"	5/8"	11/16"	7/10"	3/4"	13/16"	7/8"	15/16"	1"	1 1/16"	1 1/8"	1 1/4"	1 3/8"	1 1/2"	1 5/8"	1 3/4"	1 27/32"	2"
	Milímetros	14,28mm	15,87mm	17,46mm	17,78mm	19,05mm	20,63mm	22,22mm	23,81mm	25,40mm	26,98mm	28,57mm	31,75mm	34,92mm	38,10mm	41,27mm	44,45mm	46,83mm	50,80mm

VEÍCULO		DESCRIÇÃO	ANOS	OBSERVAÇÃO	REF.	IMAGEM
<b>HONDA</b>						
CIVIC	->	TAPA-PÓ DO CILINDRO DE RODA	1992/2000		TA-0303	
CIVIC	->	TAPA-PÓ DO CILINDRO DE RODA	2001/2006		TA-0312	
NEW CIVIC		CILINDRO MESTRE DUPLA 19,05mm	2007/2011		C-2183	
FIT		CILINDRO MESTRE DUPLA 20,63mm	2003/2008	C/ABS	C-2177	
FIT	<-	REPARO DE VEDAÇÃO DA PINÇA 52,00mm	2003/2008	MOTOR 1.4	C-1565	
FIT	->	CILINDRO DE RODA 17,46mm	2003/2008		C-3520	
FIT	->	CILINDRO DE RODA 19,05mm	2009/...		C-3416	
<b>HYUNDAI</b>						
ACCENT	->	CILINDRO DE RODA ESQUERDA 19,05mm	1995/1999		C-3515	
ACCENT	->	CILINDRO DE RODA DIREITA 19,05mm	1995/1999		C-3516	
ACCENT	->	CILINDRO DE RODA 19,05mm	2000/2002		C-3412	
ACCENT	->	REPARO DO CILINDRO DE RODA 19,05mm	1995/2002		C-1481	
ACCENT	->	GAXETA DO CILINDRO DE RODA 19,05mm	1995/2002		GA-0307	
ACCENT	->	TAPA-PÓ DO CILINDRO DE RODA	1995/2002		TA-0312	
ATOS PRIME	->	CILINDRO DE RODA 17,78mm	2000/2003		C-3439	
ATOS PRIME	->	REPARO DO CILINDRO DE RODA 17,78mm	2000/2003		C-1566	
ATOS PRIME	->	GAXETA DO CILINDRO DE RODA 17,78mm	2000/2003		GA-0301	
ATOS PRIME	->	TAPA-PÓ DO CILINDRO DE RODA	2000/2003		TA-0312	
COUPE	->	CILINDRO DE RODA ESQUERDA 19,05mm	1997/2001		C-3515	

Tabela de Conversão	Polegadas	9/16"	5/8"	11/16"	7/10"	3/4"	13/16"	7/8"	15/16"	1"	1 1/16"	1 1/8"	1 1/4"	1 3/8"	1 1/2"	1 5/8"	1 3/4"	1 27/32"	2"
	Milímetros	14,28mm	15,87mm	17,46mm	17,78mm	19,05mm	20,63mm	22,22mm	23,81mm	25,40mm	26,98mm	28,57mm	31,75mm	34,92mm	38,10mm	41,27mm	44,45mm	46,83mm	50,80mm

VEÍCULO		DESCRIÇÃO	ANOS	OBSERVAÇÃO	REF.	IMAGEM
<b>HYUNDAI</b>						
COUPE	->	CILINDRO DE RODA DIREITA 19,05mm	1997/2001		C-3516	
COUPE	->	REPARO DO CILINDRO DE RODA 19,05mm	1997/1981		C-1481	
COUPE	->	GAXETA DO CILINDRO DE RODA 19,05mm	1997/2001		GA-0307	
COUPE	->	TAPA-PÓ DO CILINDRO DE RODA	1997/2001		TA-0312	
ELANTRA	->	CILINDRO DE RODA ESQUERDA 19,05mm	1992/2000		C-3515	
ELANTRA	->	CILINDRO DE RODA DIREITA 19,05mm	1992/2000		C-3516	
ELANTRA	->	CILINDRO DE RODA 19,05mm	2001/2004		C-3412	
ELANTRA	->	REPARO DO CILINDRO DE RODA 19,05mm	1992/2004		C-1481	
ELANTRA	->	GAXETA DO CILINDRO DE RODA 19,05mm	1992/2004		GA-0307	
ELANTRA	->	TAPA-PÓ DO CILINDRO DE RODA	1992/2004		TA-0312	
EXCEL	->	REPARO DO CILINDRO DE RODA 20,63mm	1992/1995		C-1509	
EXCEL	->	GAXETA DO CILINDRO DE RODA 20,63mm	1992/1995		GA-0206	
EXCEL	->	TAPA-PÓ DO CILINDRO DE RODA	1992/1995		TA-0312	
GALLOPER		CILINDRO MESTRE DUPLO 23,81mm C/ RESERV.	1998/1999	MOTOR 3.0 V6 S/ABS	C-2131	
GALLOPER		CILINDRO MESTRE DUPLO 23,81mm C/RESERV.	1998/1999	C/ABS	C-2179	
GALLOPER	->	CILINDRO DE RODA ESQUERDA 23,81mm	1998/1999	MOTOR 2.5 TURBODIESEL	C-3528	
GALLOPER	->	CILINDRO DE RODA DIREITA 23,81mm	1998/1999	MOTOR 2.5 TURBODIESEL	C-3529	
H-100		CILINDRO MESTRE DUPLO 23,81mm	1995/2004		C-2164	

Tabela de Conversão	Polegadas	9/16"	5/8"	11/16"	7/10"	3/4"	13/16"	7/8"	15/16"	1"	1 1/16"	1 1/8"	1 1/4"	1 3/8"	1 1/2"	1 5/8"	1 3/4"	1 27/32"	2"
	Milímetros	14,28mm	15,87mm	17,46mm	17,78mm	19,05mm	20,63mm	22,22mm	23,81mm	25,40mm	26,98mm	28,57mm	31,75mm	34,92mm	38,10mm	41,27mm	44,45mm	46,83mm	50,80mm

VEÍCULO		DESCRIÇÃO	ANOS	OBSERVAÇÃO	REF.	IMAGEM
<b>HYUNDAI</b>						
H-100	->	CILINDRO DE RODA 19,05mm	1995/1999		C-3507	
H-100	->	CILINDRO DE RODA 20,63mm	2000/2004		C-3508	
H-100	->	REPARO DO CILINDRO DE RODA 19,05mm	1995/1999		C-1481	
H-100	->	REPARO DO CILINDRO DE RODA 20,63mm	2000/2004		C-1578	
H-100	->	GAXETA DO CILINDRO DE RODA 19,05mm	1995/1999		GA-0307	
H-100	->	GAXETA DO CILINDRO DE RODA 20,63mm	2000/2004		GA-0206	
H-100	->	TAPA-PÓ DO CILINDRO DE RODA	1995/2004		TA-0312	
HB20	->	CILINDRO DE RODA 17,46mm	2012/...		C-3545	
HR	->	CILINDRO DE RODA ESQUERDA 17,46mm	2005/...		C-3424	
HR	->	CILINDRO DE RODA DIREITA 17,46mm	2005/...		C-3425	
HR	->	REPARO DO CILINDRO DE RODA 17,46mm	2005/...		C-1571	
HR	->	GAXETA DO CILINDRO DE RODA 17,46mm	2005/...		GA-0309	
HR	->	TAPA-PÓ DO CILINDRO DE RODA	2005/...		TA-0373	
MATRIX	->	CILINDRO DE RODA 19,05mm	2002/2004		C-3412	
MATRIX	->	REPARO DO CILINDRO DE RODA 19,05mm	2002/2004		C-1481	
MATRIX	->	GAXETA DO CILINDRO DE RODA 19,05mm	2002/2004		GA-0307	
MATRIX	->	TAPA-PÓ DO CILINDRO DE RODA	2002/2004		TA-0312	
PORTER	->	CILINDRO DE RODA 19,05mm	2000/2003		C-3507	
PORTER	->	REPARO DO CILINDRO DE RODA 19,05mm	2000/2003		C-1481	
PORTER	->	GAXETA DO CILINDRO DE RODA 19,05mm	2000/2003		GA-0307	
PORTER	->	TAPA-PÓ DO CILINDRO DE RODA	2000/2003		TA-0312	
SONATA	->	CILINDRO DE RODA ESQUERDA 19,05mm	1994/1998		C-3515	

BUSCA POR VEÍCULOS

Tabela de Conversão	Polegadas	9/16"	5/8"	11/16"	7/10"	3/4"	13/16"	7/8"	15/16"	1"	1 1/16"	1 1/8"	1 1/4"	1 3/8"	1 1/2"	1 5/8"	1 3/4"	1 27/32"	2"
	Milímetros	14,28mm	15,87mm	17,46mm	17,78mm	19,05mm	20,63mm	22,22mm	23,81mm	25,40mm	26,98mm	28,57mm	31,75mm	34,92mm	38,10mm	41,27mm	44,45mm	46,83mm	50,80mm









VEÍCULO		DESCRIÇÃO	ANOS	OBSERVAÇÃO	REF.	IMAGEM
<b>HYUNDAI</b>						
SONATA	->	CILINDRO DE RODA DIREITA 19,05mm	1994/1998		C-3516	
SONATA	->	CILINDRO DE RODA 19,05mm	1999/2005		C-3412	
SONATA	->	REPARO DO CILINDRO DE RODA 19,05mm	1994/2005		C-1481	
SONATA	->	GAXETA DO CILINDRO DE RODA 19,05mm	1994/2005		GA-0307	
SONATA	->	TAPA-PÓ DO CILINDRO DE RODA	1994/2005		TA-0312	
TERRACAN	->	CILINDRO DE RODA 19,05mm	2003/2006		C-3412	
TERRACAN	->	REPARO DO CILINDRO DE RODA 19,05mm	2003/2006		C-1481	
TERRACAN	->	GAXETA DO CILINDRO DE RODA 19,05mm	2003/2006		GA-0307	
TERRACAN	->	TAPA-PÓ DO CILINDRO DE RODA	2003/2006		TA-0312	
<b>IVECO</b>						
DAILY		CILINDRO MESTRE DUPL0 25,40mm	1997/2007	MOD. 35.10	C-2167	
DAILY		CILINDRO MESTRE DUPL0 25,40mm	2008/...	MOD. 35S14/45S14	C-2167	
<b>JAGUAR</b>						
XJ-6	<-	REPARO DE VEDAÇÃO DA PINÇA 60,00mm	1994/1997		C-1545	
XJ-12	<-	REPARO DE VEDAÇÃO DA PINÇA 60,00mm	1993/1997		C-1545	
<b>KIA</b>						
BESTA		CILINDRO MESTRE DE EMBREAGEM 15,87mm	1993/2005		C-2634	
BESTA		CILINDRO AUXILIAR DE EMBREAGEM 19,05mm	1993/2005		C-2635	
BESTA		REPARO DO CIL. MESTRE DE EMBREAGEM 15,87mm	1993/2005		C-1642	
BESTA		REPARO DO CIL. AUXILIAR DE EMBREAGEM 19,05mm	1993/2005		C-1643	
BESTA		CILINDRO MESTRE DUPL0 22,22mm	1993/1998	MOD. 2.2/2.7	C-2089	

Tabela de Conversão	Polegadas	9/16"	5/8"	11/16"	7/10"	3/4"	13/16"	7/8"	15/16"	1"	1 1/16"	1 1/8"	1 1/4"	1 3/8"	1 1/2"	1 5/8"	1 3/4"	1 27/32"	2"
	Milímetros	14,28mm	15,87mm	17,46mm	17,78mm	19,05mm	20,63mm	22,22mm	23,81mm	25,40mm	26,98mm	28,57mm	31,75mm	34,92mm	38,10mm	41,27mm	44,45mm	46,83mm	50,80mm









VEÍCULO		DESCRIÇÃO	ANOS	OBSERVAÇÃO	REF.	IMAGEM
<b>KIA</b>						
BESTA		CILINDRO MESTRE DUPL0 25,40mm	1998/2005	MOD. GS	C-2162	
BESTA		REPARO DO CILINDRO MESTRE DUPL0 22,22mm	1993/1998	MOD. 2.2/2.7	C-1149	
BESTA		VEDANTE DO CILINDRO MESTRE	1993/1998	MOD. 2.2/2.7	VE-0207	
BESTA	<-	REPARO DE VEDAÇÃO DA PINÇA 60,50mm	1993/1998	MOD. 2.2/2.7	C-1588	
BESTA	<-	REPARO DE VEDAÇÃO DA PINÇA 46,00mm	1998/2005	MOD. GS	C-1589	
BESTA	->	CILINDRO DE RODA ESQUERDA 17,46mm	1993/1998	MOD. 2.2/2.7	C-3448	
BESTA	->	CILINDRO DE RODA DIREITA 17,46mm	1993/1998	MOD. 2.2/2.7	C-3449	
BESTA	->	REPARO DO CILINDRO DE RODA 17,46mm	1993/1998	MOD. 2.2/2.7	C-1571	
BESTA	->	GAXETA DO CILINDRO DE RODA 17,46mm	1993/1998	MOD. 2.2/2.7	GA-0309	
BESTA	->	TAPA-PÓ DO CILINDRO DE RODA	1993/1998	MOD. 2.2/2.7	TA-0373	
BONGO		CILINDRO MESTRE DE EMBREAGEM 15,87mm	1993/2004	K-2400/2700	C-2634	
BONGO		CILINDRO AUXILIAR DE EMBREAGEM 19,05mm	1993/2004	K-2400/2700	C-2635	
BONGO		REPARO DO CIL. MESTRE DE EMBREAGEM 15,87mm	1993/2004	K-2400/2700	C-1642	
BONGO		REPARO DO CIL. AUXILIAR DE EMBREAGEM 19,05mm	1993/2004	K-2400/2700	C-1643	
BONGO	->	CILINDRO DE RODA ESQUERDA 17,46mm	1993/1997	K-2400	C-3448	
BONGO	->	CILINDRO DE RODA DIREITA 17,46mm	1993/1997	K-2400	C-3449	
BONGO	->	REPARO DO CILINDRO DE RODA 17,46mm	1993/1997	K-2400	C-1571	
BONGO	->	GAXETA DO CILINDRO DE RODA 17,46mm	1993/1997	K-2400	GA-0309	
BONGO	->	TAPA-PÓ DO CILINDRO DE RODA	1993/2004	K-2400/2700	TA-0373	
CERATO	->	CILINDRO DE RODA 17,78mm	2006/2008		C-3439	
CERATO	->	REPARO DO CILINDRO DE RODA 17,78mm	2006/2008		C-1566	
CERATO	->	GAXETA DO CILINDRO DE RODA 17,78mm	2006/2008		GA-0301	
CERATO	->	TAPA-PÓ DO CILINDRO DE RODA	2006/2008		TA-0312	
CLARUS	<-	REPARO DE VEDAÇÃO DA PINÇA 57,00mm	1997/2000		C-1567	
CLARUS WAGON	<-	REPARO DE VEDAÇÃO DA PINÇA 57,00mm	1998/2000		C-1567	

BUSCA POR VEÍCULOS

Tabela de Conversão	Polegadas	9/16"	5/8"	11/16"	7/10"	3/4"	13/16"	7/8"	15/16"	1"	1 1/16"	1 1/8"	1 1/4"	1 3/8"	1 1/2"	1 5/8"	1 3/4"	1 27/32"	2"
	Milímetros	14,28mm	15,87mm	17,46mm	17,78mm	19,05mm	20,63mm	22,22mm	23,81mm	25,40mm	26,98mm	28,57mm	31,75mm	34,92mm	38,10mm	41,27mm	44,45mm	46,83mm	50,80mm

VEÍCULO		DESCRIÇÃO	ANOS	OBSERVAÇÃO	REF.	IMAGEM
<b>KIA</b>						
PICANTO	->	CILINDRO DE RODA 15,87mm	2006/2011		C-3540	
SEPHIA	<-	REPARO DE VEDAÇÃO DA PINÇA 54,00mm	1993/2001		C-1587	
SEPHIA	->	REPARO DE VEDAÇÃO DA PINÇA 33,00mm	1993/2001		C-1546	
SHUMA	<-	REPARO DE VEDAÇÃO DA PINÇA 54,00mm	1998/2000		C-1587	
SOUL	->	CILINDRO DE RODA 19,05mm	2009/...		C-3412	
SOUL	->	REPARO DO CILINDRO DE RODA 19,05mm	2009/...		C-1481	
SOUL	->	GAXETA DO CILINDRO DE RODA 19,05mm	2009/...		GA-0307	
SOUL	->	TAPA-PÓ DO CILINDRO DE RODA	2009/...		TA-0312	
SPORTAGE		VEDANTE DO CILINDRO MESTRE	1995/2004		VE-0207	
SPORTAGE	->	CILINDRO DE RODA 20,63mm	1997/2004		C-3506	
SPORTAGE	->	REPARO DO CILINDRO DE RODA 20,63mm	1997/2004		C-1411	
SPORTAGE	->	GAXETA DO CILINDRO DE RODA 20,63mm	1997/2004		GA-0213	
SPORTAGE	->	TAPA-PÓ DO CILINDRO DE RODA	1997/2004		TA-0373	
<b>MAZDA</b>						
B-2200		CIL. ATUADOR CONCÊNTRICO DE EMBREAGEM	1993/1995		C-2702	
B-2500		CIL. ATUADOR CONCÊNTRICO DE EMBREAGEM	1998/2000		C-2702	
<b>MERCEDES BENZ</b>						
CLASSE A	->	CILINDRO DE RODA 17,78mm	1999/2005		C-3501	
CLASSE A	->	REPARO DO CILINDRO DE RODA 17,78mm	1999/2005		C-1566	
CLASSE A	->	GAXETA DO CILINDRO DE RODA 17,78mm	1999/2005		GA-0301	
CLASSE A	->	TAPA-PÓ DO CILINDRO DE RODA	1999/2005		TA-0312	
CLASSE C	<-	REPARO DE VEDAÇÃO DA PINÇA 57,00mm	1994/2000	MOD. 200/230K/240	C-1567	
CLASSE C	<-	REPARO DE VEDAÇÃO DA PINÇA 54,00mm	1995/2000	MOD. 180/230	C-1558	
CLASSE C	<-	TAPA PÓ DO PINO DE GUIA	1995/2000	MOD. 180/230	TA-0322	
CLASSE C TOURING	<-	REPARO DE VEDAÇÃO DA PINÇA 54,00mm	1996/2001	MOD. 180/200/230	C-1558	
CLASSE C TOURING	<-	TAPA PÓ DO PINO DE GUIA	1996/2001	MOD. 180/200/230	TA-0322	
CLASSE E	<-	REPARO DE VEDAÇÃO DA PINÇA 57,00mm	1995/2002	MOD. 200/200K/230/240/280/320/420	C-1567	
CLASSE E	->	REPARO DE VEDAÇÃO DA PINÇA 35,00mm	1995/2002	MOD. 280/320/420	C-1541	
CLASSE E TOURING	<-	REPARO DE VEDAÇÃO DA PINÇA 57,00mm	1996/2003	MOD. 200/200K/230/240/280/320	C-1567	
CLK	<-	REPARO DE VEDAÇÃO DA PINÇA 57,00mm	1998/2002	MOD. 200K/230K/320	C-1567	

Tabela de Conversão	Polegadas	9/16"	5/8"	11/16"	7/10"	3/4"	13/16"	7/8"	15/16"	1"	1 1/16"	1 1/8"	1 1/4"	1 3/8"	1 1/2"	1 5/8"	1 3/4"	1 27/32"	2"
	Milímetros	14,28mm	15,87mm	17,46mm	17,78mm	19,05mm	20,63mm	22,22mm	23,81mm	25,40mm	26,98mm	28,57mm	31,75mm	34,92mm	38,10mm	41,27mm	44,45mm	46,83mm	50,80mm

VEÍCULO		DESCRIÇÃO	ANOS	OBSERVAÇÃO	REF.	IMAGEM
<b>MERCEDES BENZ</b>						
CLK	->	REPARO DE VEDAÇÃO DA PINÇA 35,00mm	1998/2002	MOD. 320	C-1541	
MB-180		CILINDRO MESTRE DE EMBREAGEM 19,05mm	1994/1996		C-2632	
MB-180		CILINDRO AUXILIAR DE EMBREAGEM 25,40mm	1994/1996		C-2633	
MB-180		REPARO DO CIL. AUXILIAR DE EMBREAGEM 25,40mm	1994/1996		C-1641	
MB-180	<-	REPARO DE VEDAÇÃO DA PINÇA 52,00mm	1994/1996		C-1576	
MB-180	->	CILINDRO DE RODA 25,40mm	1994/1996		C-3454	
MB-180	->	REPARO DO CILINDRO DE RODA 25,40mm	1994/1996		C-1574	
MB-180	->	GAXETA DO CILINDRO DE RODA 25,40mm	1994/1996		GA-0303	
MB-180	->	TAPA-PÓ DO CILINDRO DE RODA	1994/1996		TA-0375	
SLK	<-	REPARO DE VEDAÇÃO DA PINÇA 57,00mm	2000/2004	MOD. 320/32 AMG	C-1567	
SPRINTER		CILINDRO MESTRE DE EMBREAGEM 19,05mm	1997/...		C-2630	
SPRINTER		CILINDRO AUXILIAR DE EMBREAGEM 22,22mm	1997/2002	MOD. 310/312/412	C-2631	
SPRINTER		REPARO DO CIL. AUXILIAR DE EMBREAGEM 22,22mm	1997/2002	MOD. 310/312/412	C-1640	
SPRINTER		CILINDRO MESTRE DUPLA 23,81mm	1997/2000	MOD. 310	C-2090	
SPRINTER		CILINDRO MESTRE DUPLA 25,40mm	2000/2004	MOD. 312/412	C-2148	
SPRINTER		CILINDRO MESTRE DUPLA 25,40mm	2002/...	MOD. 311/313/413	C-2166	
SPRINTER		REPARO DO CILINDRO MESTRE DUPLA 23,81mm	1997/2000	MOD. 310	C-1155	
SPRINTER		VEDANTE DO CILINDRO MESTRE	1997/...		VE-0204	
SPRINTER	<-	REPARO DE VEDAÇÃO DA PINÇA 44,00mm	1997/...		C-1577	
SPRINTER	->	CILINDRO DE RODA ESQUERDA 20,63mm	1997/2000		C-3466	

BUSCA POR VEÍCULOS

Tabela de Conversão	Polegadas	9/16"	5/8"	11/16"	7/10"	3/4"	13/16"	7/8"	15/16"	1"	1 1/16"	1 1/8"	1 1/4"	1 3/8"	1 1/2"	1 5/8"	1 3/4"	1 27/32"	2"
	Milímetros	14,28mm	15,87mm	17,46mm	17,78mm	19,05mm	20,63mm	22,22mm	23,81mm	25,40mm	26,98mm	28,57mm	31,75mm	34,92mm	38,10mm	41,27mm	44,45mm	46,83mm	50,80mm



VEÍCULO		DESCRIÇÃO	ANOS	OBSERVAÇÃO	REF.	IMAGEM
<b>MERCEDES BENZ</b>						
SPRINTER	->	CILINDRO DE RODA DIREITA 20,63mm	1997/2000		C-3467	
SPRINTER	->	REPARO DO CILINDRO DE RODA 20,63mm	1997/2000		C-1581	
SPRINTER	->	COPO DO CILINDRO DE RODA 20,63mm	1997/2000		CO-1317	
SPRINTER	->	TAPA-PÓ DO CILINDRO DE RODA	1997/2000		TA-0314	
<b>MERCEDES BENZ - CAMINHÕES</b>						
L/LA/LK/LP/LS/O/OH-321		REPARO DO CILINDRO MESTRE SIMPLES 31,75mm	1957/1965		C-1040	
L/LA/LK/LP/LS/O/OH-321		REPARO DO CILINDRO MESTRE DUPLO 31,75mm	1965/1970		C-1077	
L/LA/LK/LP/LS/O/OH-321	<-	CILINDRO DE RODA 41,27mm	1957/1965		C-3300	
L/LA/LK/LP/LS/O/OH-321	<-	REPARO DO CILINDRO DE RODA 41,27mm	1957/1965		C-1453	
L/LA/LK/LP/LS/O/OH-321	<-	COPO DO CILINDRO DE RODA 41,27mm	1957/1965		CO-1316	
L/LA/LK/LP/LS/O/OH-321	<-	TAPA-PÓ DO CILINDRO DE RODA	1957/1965		TA-0327	
L/LA/LK/LP/LS/O/OH-321	->	CILINDRO DE RODA 44,45mm	1965/1970		C-3301	
L/LA/LK/LP/LS/O/OH-321	->	REPARO DO CILINDRO DE RODA 44,45mm	1965/1970		C-1454	
L/LA/LK/LP/LS/O/OH-321	->	COPO DO CILINDRO DE RODA 44,45mm	1965/1970		CO-1303	
L/LA/LK/LP/LS/O/OH-321	->	TAPA-PÓ DO CILINDRO DE RODA	1965/1970		TA-0328	
0-352	<-	CILINDRO DE RODA 46,83mm	1970/1978		C-3302	
0-352	<-	REPARO DO CILINDRO DE RODA 46,83mm	1970/1978		C-1464	
0-352	<-	COPO DO CILINDRO DE RODA 46,83mm	1970/1978		CO-1314	
0-352	<-	TAPA-PÓ DO CILINDRO DE RODA	1970/1978		TA-0328	
0-352	->	CILINDRO DE RODA 44,45mm	1965/1970		C-3301	
0-352	->	REPARO DO CILINDRO DE RODA 44,45mm	1965/1970		C-1454	
0-352	->	COPO DO CILINDRO DE RODA 44,45mm	1965/1970		CO-1303	
0-352	->	TAPA-PÓ DO CILINDRO DE RODA	1965/1970		TA-0328	
0-355		CILINDRO MESTRE SIMPLES 34,92mm	1970/1978		C-2159	
0-355		REPARO DO CILINDRO MESTRE SIMPLES 34,92mm	1970/1978		C-1070	
O/OH-362/362 A		CILINDRO MESTRE SIMPLES 34,92mm	1978/1989	MOD. 0	C-2159	
O/OH-362/362 A		REPARO DO CILINDRO MESTRE DUPLO 38,10mm	1970/1978	MOD. OH	C-1078	
O/OH-362/362 A		REPARO DO CILINDRO MESTRE SIMPLES 34,92mm	1978/1989	MOD. 0	C-1070	

Tabela de Conversão	Polegadas	9/16"	5/8"	11/16"	7/10"	3/4"	13/16"	7/8"	15/16"	1"	1 1/16"	1 1/8"	1 1/4"	1 3/8"	1 1/2"	1 5/8"	1 3/4"	1 27/32"	2"
	Milímetros	14,28mm	15,87mm	17,46mm	17,78mm	19,05mm	20,63mm	22,22mm	23,81mm	25,40mm	26,98mm	28,57mm	31,75mm	34,92mm	38,10mm	41,27mm	44,45mm	46,83mm	50,80mm

VEÍCULO		DESCRIÇÃO	ANOS	OBSERVAÇÃO	REF.	IMAGEM
<b>MERCEDES BENZ - CAMINHÕES</b>						
0/OH-362/362 A	<-	CILINDRO DE RODA 46,83mm	1978/1989	MOD. 0	C-3302	
0/OH-362/362 A	<-	REPARO DO CILINDRO DE RODA 46,83mm	1978/1989	MOD. 0	C-1464	
0/OH-362/362 A	<-	COPO DO CILINDRO DE RODA 46,83mm	1978/1989	MOD. 0	CO-1314	
0/OH-362/362 A	<-	TAPA-PÓ DO CILINDRO DE RODA	1978/1989	MOD. 0	TA-0328	
0/OH-362/362 A	->	CILINDRO DE RODA 50,80mm	1978/1989	MOD. 0	C-3303	
0/OH-362/362 A	->	REPARO DO CILINDRO DE RODA 50,80mm	1978/1989	MOD. 0	C-1478	
0/OH-362/362 A	->	COPO DO CILINDRO DE RODA 50,80mm	1978/1989	MOD. 0	CO-1308	
0/OH-362/362 A	->	TAPA-PÓ DO CILINDRO DE RODA	1978/1989	MOD. 0	TA-0308	
0-364		CILINDRO MESTRE SIMPLES 34,92mm	1978/1981		C-2159	
0-364		CILINDRO MESTRE SIMPLES 34,92mm	1982/1989	CIRCUITO TRASEIRO	C-2159	
0-364		REPARO DO CILINDRO MESTRE SIMPLES 34,92mm	1978/1981		C-1070	
0-364		REPARO DO CILINDRO MESTRE SIMPLES 31,75mm	1982/1989	CIRCUITO DIANTEIRO	C-1039	
0-364		REPARO DO CILINDRO MESTRE SIMPLES 34,92mm	1982/1989	CIRCUITO TRASEIRO	C-1070	
0-364	<-	CILINDRO DE RODA 46,83mm	1978/1989		C-3302	
0-364	<-	REPARO DO CILINDRO DE RODA 46,83mm	1978/1989		C-1464	
0-364	<-	COPO DO CILINDRO DE RODA 46,83mm	1978/1989		CO-1314	
0-364	<-	TAPA-PÓ DO CILINDRO DE RODA	1978/1989		TA-0328	
0-370		CILINDRO MESTRE DE EMBREAGEM 19,05mm	1984/...	MOD. R/R/S	C-2601	
0-370		CILINDRO MESTRE DE EMBREAGEM 23,81mm	1984/...		C-2603	
0-370		CILINDRO AUXILIAR DE EMBREAGEM 38,10mm	1984/...		C-2614	
0-370		REPARO DO CIL. MESTRE DE EMBREAGEM 23,81mm	1984/...		C-1615	
0-370		REPARO DO CIL. MESTRE DE EMBREAGEM 19,05mm	1984/...	MOD. R/R/S	C-1626	
0-370		REPARO DO CIL. AUXILIAR DE EMBREAGEM 38,10mm	1984/...		C-1616	
0-370		VEDANTE DO CILINDRO MESTRE	1984/...	MOD. R/R/S	VE-0202	
0-370		VEDANTE DO CILINDRO MESTRE	1984/...		VE-0204	

BUSCA POR VEÍCULOS

Tabela de Conversão	Polegadas	9/16"	5/8"	11/16"	7/10"	3/4"	13/16"	7/8"	15/16"	1"	1 1/16"	1 1/8"	1 1/4"	1 3/8"	1 1/2"	1 5/8"	1 3/4"	1 27/32"	2"
	Milímetros	14,28mm	15,87mm	17,46mm	17,78mm	19,05mm	20,63mm	22,22mm	23,81mm	25,40mm	26,98mm	28,57mm	31,75mm	34,92mm	38,10mm	41,27mm	44,45mm	46,83mm	50,80mm

VEÍCULO		DESCRIÇÃO	ANOS	OBSERVAÇÃO	REF.	IMAGEM
<b>MERCEDES BENZ - CAMINHÕES</b>						
0-371		CILINDRO MESTRE DE EMBREAGEM 23,81mm	1984/...		C-2603	
0-371		CILINDRO MESTRE DE EMBREAGEM 23,81mm	1987/...		C-2607	
0-371		CILINDRO AUXILIAR DE EMBREAGEM 38,10mm	1984/...		C-2614	
0-371		REPARO DO CIL. MESTRE DE EMBREAGEM 23,81mm	1984/...		C-1615	
0-371		REPARO DO CIL. MESTRE DE EMBREAGEM 23,81mm	1987/...		C-1629	
0-371		REPARO DO CIL. AUXILIAR DE EMBREAGEM 38,10mm	1984/...		C-1616	
0-371		VEDANTE DO CILINDRO MESTRE	1984/...		VE-0204	
0-371		VEDANTE DO CILINDRO MESTRE	1987/...		VE-0202	
0-400 R/RS/RSD/RSL/UP		CILINDRO MESTRE DE EMBREAGEM 20,63mm	1992/...		C-2622	
0-400 R/RS/RSD/RSL/UP		REPARO DO CIL. MESTRE DE EMBREAGEM 20,63mm	1992/...		C-1625	
L/LO-608 D/E		CILINDRO MESTRE DE EMBREAGEM 19,05mm	1976/1986		C-2600	
L/LO-608 D/E		CILINDRO AUXILIAR DE EMBREAGEM 28,57mm	1976/1986		C-2610	
L/LO-608 D/E		REPARO DO CIL. MESTRE DE EMBREAGEM 19,05mm	1976/1986		C-1617	
L/LO-608 D/E		REPARO DO CIL. AUXILIAR DE EMBREAGEM 28,57mm	1976/1986		C-1618	
L/LO-608 D/E		VEDANTE DO CILINDRO MESTRE	1976/1986		VE-0202	
L/LO-608 D/E		CILINDRO MESTRE SIMPLES 22,22mm	1972/1975		C-2154	
L/LO-608 D/E		CILINDRO MESTRE SIMPLES 22,22mm	1976/1986		C-2069	
L/LO-608 D/E		REPARO DO CILINDRO MESTRE SIMPLES 22,22mm	1972/1986		C-1104	
L/LO-608 D/E		VEDANTE DO CILINDRO MESTRE	1972/1986		VE-0201	
L/LO-608 D/E	<-	CILINDRO DE RODA 22,22mm	1972/1986		C-3304	
L/LO-608 D/E	<-	REPARO DO CILINDRO DE RODA 22,22mm	1972/1986		C-1488	

Tabela de Conversão	Polegadas	9/16"	5/8"	11/16"	7/10"	3/4"	13/16"	7/8"	15/16"	1"	1 1/16"	1 1/8"	1 1/4"	1 3/8"	1 1/2"	1 5/8"	1 3/4"	1 27/32"	2"
	Milímetros	14,28mm	15,87mm	17,46mm	17,78mm	19,05mm	20,63mm	22,22mm	23,81mm	25,40mm	26,98mm	28,57mm	31,75mm	34,92mm	38,10mm	41,27mm	44,45mm	46,83mm	50,80mm



VEÍCULO		DESCRIÇÃO	ANOS	OBSERVAÇÃO	REF.	IMAGEM
<b>MERCEDES BENZ - CAMINHÕES</b>						
L/LO-608 D/E	<-	COPO DO CILINDRO DE RODA 22,22mm	1972/1986		CO-1315	
L/LO-608 D/E	<-	TAPA-PÓ DO CILINDRO DE RODA	1972/1986		TA-0347	
L/LO-608 D/E	->	CILINDRO DE RODA 22,22mm	1972/1986		C-3304	
L/LO-608 D/E	->	REPARO DO CILINDRO DE RODA 22,22mm	1972/1986		C-1488	
L/LO-608 D/E	->	COPO DO CILINDRO DE RODA 22,22mm	1972/1986		CO-1315	
L/LO-608 D/E	->	TAPA-PÓ DO CILINDRO DE RODA	1972/1986		TA-0347	
L/LO-708 D/E		CILINDRO MESTRE DE EMBREAGEM 19,05mm	1987/1988		C-2600	
L/LO-708 D/E		CILINDRO AUXILIAR DE EMBREAGEM 28,57mm	1987/1988		C-2610	
L/LO-708 D/E		REPARO DO CIL. MESTRE DE EMBREAGEM 19,05mm	1987/1988		C-1617	
L/LO-708 D/E		REPARO DO CIL. AUXILIAR DE EMBREAGEM 28,57mm	1987/1988		C-1618	
L/LO-708 D/E		VEDANTE DO CILINDRO MESTRE	1987/1988		VE-0202	
L/LO-708 D/E		CILINDRO MESTRE SIMPLES 23,81mm	1987/1988		C-2086	
L/LO-708 D/E		REPARO DO CILINDRO MESTRE SIMPLES 23,81mm	1987/1988		C-1079	
L/LO-708 D/E		VEDANTE DO CILINDRO MESTRE	1987/1988		VE-0202	
L/LO-708 D/E	<-	CILINDRO DE RODA 23,81mm	1987/1988		C-3332	
L/LO-708 D/E	<-	REPARO DO CILINDRO DE RODA 23,81mm	1987/1988		C-1522	
L/LO-708 D/E	<-	GAXETA DO CILINDRO DE RODA 23,81mm	1987/1988		GA-0308	
L/LO-708 D/E	<-	TAPA-PÓ DO CILINDRO DE RODA	1987/1988		TA-0347	
L/LO-708 D/E	->	CILINDRO DE RODA 23,81mm	1987/1988		C-3332	
L/LO-708 D/E	->	REPARO DO CILINDRO DE RODA 23,81mm	1987/1988		C-1522	
L/LO-708 D/E	->	GAXETA DO CILINDRO DE RODA 23,81mm	1987/1988		GA-0308	
L/LO-708 D/E	->	TAPA-PÓ DO CILINDRO DE RODA	1987/1988		TA-0347	
L-709		CILINDRO MESTRE DE EMBREAGEM 19,05mm	1989/1996		C-2602	
L-709		CILINDRO AUXILIAR DE EMBREAGEM 28,57mm	1989/1996		C-2611	
L-709		REPARO DO CIL. MESTRE DE EMBREAGEM 19,05mm	1989/1996		C-1627	

BUSCA POR VEÍCULOS

Tabela de Conversão	Polegadas	9/16"	5/8"	11/16"	7/10"	3/4"	13/16"	7/8"	15/16"	1"	1 1/16"	1 1/8"	1 1/4"	1 3/8"	1 1/2"	1 5/8"	1 3/4"	1 27/32"	2"
	Milímetros	14,28mm	15,87mm	17,46mm	17,78mm	19,05mm	20,63mm	22,22mm	23,81mm	25,40mm	26,98mm	28,57mm	31,75mm	34,92mm	38,10mm	41,27mm	44,45mm	46,83mm	50,80mm

VEÍCULO		DESCRIÇÃO	ANOS	OBSERVAÇÃO	REF.	IMAGEM
<b>MERCEDES BENZ - CAMINHÕES</b>						
L-709		REPARO DO CIL. AUXILIAR DE EMBREAGEM 28,57mm	1989/1996		C-1621	
L-709		VEDANTE DO CILINDRO MESTRE	1989/1996		VE-0202	
L-709		CILINDRO MESTRE DUPL0 31,75mm	1989/1996		C-2149	
L-709		REPARO DO CILINDRO MESTRE DUPL0 31,75mm	1989/1996		C-1113	
L-709		VEDANTE DO CILINDRO MESTRE	1989/1996		VE-0204	
L-709	<	REPARO DE VEDAÇÃO DA PINÇA 60,00mm	1989/1996		C-1526	
L-709	->	CILINDRO DE RODA 28,57mm	1989/1996		C-3334	
L-709	->	REPARO DO CILINDRO DE RODA 28,57mm	1989/1996		C-1529	
L-709	->	GAXETA DO CILINDRO DE RODA 28,57mm	1989/1996		GA-0317	
L-709	->	TAPA-PÓ DO CILINDRO DE RODA	1989/1996		TA-0359	
L-710		CILINDRO MESTRE DE EMBREAGEM 19,05mm	1996/...		C-2602	
L-710		CILINDRO AUXILIAR DE EMBREAGEM 28,57mm	1996/...		C-2611	
L-710		REPARO DO CIL. MESTRE DE EMBREAGEM 19,05mm	1996/...		C-1627	
L-710		REPARO DO CIL. AUXILIAR DE EMBREAGEM 28,57mm	1996/...		C-1621	
L-710		VEDANTE DO CILINDRO MESTRE	1996/...		VE-0202	
L-710		CILINDRO MESTRE DUPL0 31,75mm	1996/2002		C-2149	
L-710		REPARO DO CILINDRO MESTRE DUPL0 31,75mm	1996/2002		C-1113	
L-710		VEDANTE DO CILINDRO MESTRE	1996/2002		VE-0204	
L-710	<	REPARO DE VEDAÇÃO DA PINÇA 60,00mm	1996/2002		C-1526	
L-710	->	CILINDRO DE RODA 28,57mm	1996/2002		C-3334	
L-710	->	REPARO DO CILINDRO DE RODA 28,57mm	1996/2002		C-1529	
L-710	->	GAXETA DO CILINDRO DE RODA 28,57mm	1996/2002		GA-0317	
L-710	->	TAPA-PÓ DO CILINDRO DE RODA	1996/2002		TA-0359	
LO/OF-809		CILINDRO MESTRE DE EMBREAGEM 19,05mm	1989/...		C-2602	
LO/OF-809		CILINDRO AUXILIAR DE EMBREAGEM 28,57mm	1989/...		C-2611	

Tabela de Conversão	Polegadas	9/16"	5/8"	11/16"	7/10"	3/4"	13/16"	7/8"	15/16"	1"	1 1/16"	1 1/8"	1 1/4"	1 3/8"	1 1/2"	1 5/8"	1 3/4"	1 27/32"	2"
	Milímetros	14,28mm	15,87mm	17,46mm	17,78mm	19,05mm	20,63mm	22,22mm	23,81mm	25,40mm	26,98mm	28,57mm	31,75mm	34,92mm	38,10mm	41,27mm	44,45mm	46,83mm	50,80mm

VEÍCULO		DESCRIÇÃO	ANOS	OBSERVAÇÃO	REF.	IMAGEM
<b>MERCEDES BENZ - CAMINHÕES</b>						
LO/OF-809		REPARO DO CIL. MESTRE DE EMBREAGEM 19,05mm	1989/...		C-1627	
LO/OF-809		REPARO DO CIL. AUXILIAR DE EMBREAGEM 28,57mm	1989/...		C-1621	
LO/OF-809		VEDANTE DO CILINDRO MESTRE	1989/...		VE-0202	
L/LO/OF-812		CILINDRO MESTRE DE EMBREAGEM 19,05mm	1989/...		C-2602	
L/LO/OF-812		CILINDRO AUXILIAR DE EMBREAGEM 28,57mm	1989/...		C-2611	
L/LO/OF-812		REPARO DO CIL. MESTRE DE EMBREAGEM 19,05mm	1989/...		C-1627	
L/LO/OF-812		REPARO DO CIL. AUXILIAR DE EMBREAGEM 28,57mm	1989/...		C-1621	
L/LO/OF-812		VEDANTE DO CILINDRO MESTRE	1989/...		VE-0202	
LO-814		CILINDRO MESTRE DE EMBREAGEM 20,64mm	TODOS		C-2689	
LO-814		CILINDRO MESTRE SIMPLES 31,75mm	1996/...		C-2169	
LO-814		REPARO DO CILINDRO MESTRE SIMPLES 31,75mm	1996/...		C-1023	
LO-814	<	REPARO DE VEDAÇÃO DA PINÇA 60,00mm	1996/...		C-1526	
L/LO-912		CILINDRO MESTRE DE EMBREAGEM 19,05mm	1989/...		C-2602	
L/LO-912		CILINDRO AUXILIAR DE EMBREAGEM 28,57mm	1989/...		C-2611	
L/LO-912		REPARO DO CIL. MESTRE DE EMBREAGEM 19,05mm	1989/...		C-1627	
L/LO-912		REPARO DO CIL. AUXILIAR DE EMBREAGEM 28,57mm	1989/...		C-1621	
L/LO-912		VEDANTE DO CILINDRO MESTRE	1989/...		VE-0202	
L/LO-912		CILINDRO MESTRE SIMPLES 31,75mm	1996/...	SIST. VARGA	C-2169	
L/LO-912		REPARO DO CILINDRO MESTRE SIMPLES 22,22mm	1989/...	SIST. ATE CIRCUITO TRASEIRO	C-1111	
L/LO-912		REPARO DO CILINDRO MESTRE SIMPLES 28,57mm	1989/...	SIST. ATE CIRCUITO DIANTEIRO	C-1112	
L/LO-912		REPARO DO CILINDRO MESTRE SIMPLES 31,75mm	1996/...	SIST. VARGA	C-1023	
L/LO-912	<	REPARO DE VEDAÇÃO DA PINÇA 60,00mm	1989/...		C-1526	
L/LO-912	>	CILINDRO DE RODA 28,57mm	1989/...		C-3334	
L/LO-912	>	REPARO DO CILINDRO DE RODA 28,57mm	1989/...		C-1529	
L/LO-912	>	GAXETA DO CILINDRO DE RODA 28,57mm	1989/...		GA-0317	

BUSCA POR VEÍCULOS

Tabela de Conversão	Polegadas	9/16"	5/8"	11/16"	7/10"	3/4"	13/16"	7/8"	15/16"	1"	1 1/16"	1 1/8"	1 1/4"	1 3/8"	1 1/2"	1 5/8"	1 3/4"	1 27/32"	2"
	Milímetros	14,28mm	15,87mm	17,46mm	17,78mm	19,05mm	20,63mm	22,22mm	23,81mm	25,40mm	26,98mm	28,57mm	31,75mm	34,92mm	38,10mm	41,27mm	44,45mm	46,83mm	50,80mm

VEÍCULO		DESCRIÇÃO	ANOS	OBSERVAÇÃO	REF.	IMAGEM
<b>MERCEDES BENZ - CAMINHÕES</b>						
L/LO-912	->	TAPA-PÓ DO CILINDRO DE RODA	1989/...		TA-0359	
L0-915		CILINDRO MESTRE DE EMBREAGEM 20,64mm	TODOS		C-2689	
L-914/914 E		CILINDRO MESTRE SIMPLES 31,75mm	1996/...		C-2169	
L-914/914 E		REPARO DO CILINDRO MESTRE SIMPLES 31,75mm	1996/...		C-1023	
L-914/914 E	<-	REPARO DE VEDAÇÃO DA PINÇA 60,00mm	1996/...		C-1526	
ACCELO 915 C		CILINDRO MESTRE DE EMBREAGEM 20,63mm	2004/...		C-2655	
ACCELO 915 C		REPARO DO CIL. MESTRE DE EMBREAGEM 20,63mm	2004/...		C-1645	
L/LA/LS-1111		REPARO DO CILINDRO MESTRE DUPL0 31,75mm	1965/1970	SIST. BENDIX	C-1006	
L/LA/LS-1111		REPARO DO CILINDRO MESTRE DUPL0 31,75mm	1965/1970	SIST. VARGA	C-1077	
L/LA/LS-1111	<-	CILINDRO DE RODA 41,27mm	1965/1970		C-3300	
L/LA/LS-1111	<-	REPARO DO CILINDRO DE RODA 41,27mm	1965/1970		C-1453	
L/LA/LS-1111	<-	COPO DO CILINDRO DE RODA 41,27mm	1965/1970		CO-1316	
L/LA/LS-1111	<-	TAPA-PÓ DO CILINDRO DE RODA	1965/1970		TA-0327	
L/LA/LK/LS/OF-1113		CILINDRO MESTRE SIMPLES 34,92mm	1983/1989	MOD. L	C-2159	
L/LA/LK/LS/OF-1113		REPARO DO CILINDRO MESTRE DUPL0 31,75mm	1965/1983	SIST. BENDIX	C-1006	
L/LA/LK/LS/OF-1113		REPARO DO CILINDRO MESTRE DUPL0 31,75mm	1965/1983	SIST. VARGA	C-1077	
L/LA/LK/LS/OF-1113		REPARO DO CILINDRO MESTRE SIMPLES 34,92mm	1983/1989	MOD. L	C-1070	
L/LA/LK/LS/OF-1113		REPARO DO CILINDRO MESTRE DUPL0 31,75mm	1983/1989	MOD. LA/LK/LS	C-1077	
L/LA/LK/LS/OF-1113	<-	CILINDRO DE RODA 41,27mm	1965/1983	MOD. L/LA/LK/LS	C-3300	
L/LA/LK/LS/OF-1113	<-	CILINDRO DE RODA 41,27mm	1983/1989	MOD. LA/LK/LS	C-3300	
L/LA/LK/LS/OF-1113	<-	REPARO DO CILINDRO DE RODA 41,27mm	1965/1983	MOD. L/LA/LK/LS	C-1453	
L/LA/LK/LS/OF-1113	<-	REPARO DO CILINDRO DE RODA 41,27mm	1983/1989	MOD. LA/LK/LS	C-1453	
L/LA/LK/LS/OF-1113	<-	COPO DO CILINDRO DE RODA 41,27mm	1965/1983	MOD. L/LA/LK/LS	CO-1316	
L/LA/LK/LS/OF-1113	<-	COPO DO CILINDRO DE RODA 41,27mm	1983/1989	MOD. LA/LK/LS	CO-1316	
L/LA/LK/LS/OF-1113	<-	TAPA-PÓ DO CILINDRO DE RODA	1965/1983	MOD. L/LA/LK/LS	TA-0327	
L/LA/LK/LS/OF-1113	<-	TAPA-PÓ DO CILINDRO DE RODA	1983/1989	MOD. LA/LK/LS	TA-0327	

Tabela de Conversão	Polegadas	9/16"	5/8"	11/16"	7/10"	3/4"	13/16"	7/8"	15/16"	1"	1 1/16"	1 1/8"	1 1/4"	1 3/8"	1 1/2"	1 5/8"	1 3/4"	1 27/32"	2"
	Milímetros	14,28mm	15,87mm	17,46mm	17,78mm	19,05mm	20,63mm	22,22mm	23,81mm	25,40mm	26,98mm	28,57mm	31,75mm	34,92mm	38,10mm	41,27mm	44,45mm	46,83mm	50,80mm

VEÍCULO		DESCRIÇÃO	ANOS	OBSERVAÇÃO	REF.	IMAGEM
<b>MERCEDES BENZ - CAMINHÕES</b>						
L/LA/LK/LS/OF-1113	->	CILINDRO DE RODA 44,45mm	1965/1989		C-3301	
L/LA/LK/LS/OF-1113	->	REPARO DO CILINDRO DE RODA 44,45mm	1965/1989		C-1454	
L/LA/LK/LS/OF-1113	->	COPO DO CILINDRO DE RODA 44,45mm	1965/1989		CO-1303	
L/LA/LK/LS/OF-1113	->	TAPA-PÓ DO CILINDRO DE RODA	1965/1989		TA-0328	
L-1114		CILINDRO MESTRE SIMPLES 31,75mm	1996/...		C-2169	
L-1114		REPARO DO CILINDRO MESTRE SIMPLES 31,75mm	1996/...		C-1023	
L-1114	<-	REPARO DE VEDAÇÃO DA PINÇA 60,00mm	1996/...		C-1526	
L-1116		CILINDRO MESTRE SIMPLES 34,92mm	1983/1989		C-2159	
L-1116		REPARO DO CILINDRO MESTRE SIMPLES 34,92mm	1983/1989		C-1070	
L-1116	<-	CILINDRO DE RODA 44,45mm	1983/1989		C-3301	
L-1116	<-	REPARO DO CILINDRO DE RODA 44,45mm	1983/1989		C-1454	
L-1116	<-	COPO DO CILINDRO DE RODA 44,45mm	1983/1989		CO-1303	
L-1116	<-	TAPA-PÓ DO CILINDRO DE RODA	1983/1989		TA-0328	
L/LK/LP-1214		CILINDRO AUXILIAR DE EMBREAGEM 38,10mm	1989/...		C-2614	
L/LK/LP-1214		REPARO DO CIL. AUXILIAR DE EMBREAGEM 38,10mm	1989/...		C-1616	
L-1215		CILINDRO MESTRE DE EMBREAGEM 20,63mm	2000/...		C-2655	
L-1215		REPARO DO CIL. MESTRE DE EMBREAGEM 20,63mm	2000/...		C-1645	
L/LS/LK/OF/OH-1313		CILINDRO MESTRE SIMPLES 34,92mm	1983/1989		C-2159	
L/LS/LK/OF/OH-1313		REPARO DO CILINDRO MESTRE DUPLO 38,10mm	1970/1983		C-1078	
L/LS/LK/OF/OH-1313		REPARO DO CILINDRO MESTRE SIMPLES 34,92mm	1983/1989		C-1070	
L/LS/LK/OF/OH-1313	<-	CILINDRO DE RODA 46,83mm	1976/1989		C-3302	
L/LS/LK/OF/OH-1313	<-	REPARO DO CILINDRO DE RODA 46,83mm	1976/1989		C-1464	
L/LS/LK/OF/OH-1313	<-	COPO DO CILINDRO DE RODA 46,83mm	1976/1989		CO-1314	
L/LS/LK/OF/OH-1313	<-	TAPA-PÓ DO CILINDRO DE RODA	1976/1989		TA-0328	

BUSCA POR VEÍCULOS

Tabela de Conversão	Polegadas	9/16"	5/8"	11/16"	7/10"	3/4"	13/16"	7/8"	15/16"	1"	1 1/16"	1 1/8"	1 1/4"	1 3/8"	1 1/2"	1 5/8"	1 3/4"	1 27/32"	2"
	Milímetros	14,28mm	15,87mm	17,46mm	17,78mm	19,05mm	20,63mm	22,22mm	23,81mm	25,40mm	26,98mm	28,57mm	31,75mm	34,92mm	38,10mm	41,27mm	44,45mm	46,83mm	50,80mm



VEÍCULO		DESCRIÇÃO	ANOS	OBSERVAÇÃO	REF.	IMAGEM
<b>MERCEDES BENZ - CAMINHÕES</b>						
L/LS/LK/OF/OH-1313	->	CILINDRO DE RODA 50,80mm	1976/1989		C-3303	
L/LS/LK/OF/OH-1313	->	REPARO DO CILINDRO DE RODA 50,80mm	1976/1989		C-1478	
L/LS/LK/OF/OH-1313	->	COPO DO CILINDRO DE RODA 50,80mm	1976/1989		CO-1308	
L/LS/LK/OF/OH-1313	->	TAPA-PÓ DO CILINDRO DE RODA	1976/1989		TA-0308	
L/OH-1316		CILINDRO AUXILIAR DE EMBREAGEM 38,10mm	1970/1989		C-2614	
L/OH-1316		REPARO DO CIL. MESTRE DE EMBREAGEM 23,81mm	1970/1989		C-1615	
L/OH-1316		REPARO DO CIL. AUXILIAR DE EMBREAGEM 38,10mm	1970/1989		C-1616	
L/OH-1316		VEDANTE DO CILINDRO MESTRE	1970/1989		VE-0204	
L/OH-1316		REPARO DO CILINDRO MESTRE DUPL0 38,10mm	1970/1989		C-1078	
L/OH-1316	<-	CILINDRO DE RODA 46,83mm	1970/1989		C-3302	
L/OH-1316	<-	REPARO DO CILINDRO DE RODA 46,83mm	1970/1989		C-1464	
L/OH-1316	<-	COPO DO CILINDRO DE RODA 46,83mm	1970/1989		CO-1314	
L/OH-1316	<-	TAPA-PÓ DO CILINDRO DE RODA	1970/1989		TA-0328	
L/OH-1316	->	CILINDRO DE RODA 50,80mm	1970/1989		C-3303	
L/OH-1316	->	REPARO DO CILINDRO DE RODA 50,80mm	1970/1989		C-1478	
L/OH-1316	->	COPO DO CILINDRO DE RODA 50,80mm	1970/1989		CO-1308	
L/OH-1316	->	TAPA-PÓ DO CILINDRO DE RODA	1970/1989		TA-0308	
OH-1317		CILINDRO AUXILIAR DE EMBREAGEM 38,10mm	1970/1989		C-2614	
OH-1317		REPARO DO CIL. MESTRE DE EMBREAGEM 23,81mm	1970/1989		C-1615	
OH-1317		REPARO DO CIL. AUXILIAR DE EMBREAGEM 38,10mm	1970/1989		C-1616	
OH-1317		VEDANTE DO CILINDRO MESTRE	1970/1989		VE-0204	
OF/OH-1318		CILINDRO MESTRE DE EMBREAGEM 23,81mm	1987/...		C-2603	
OF/OH-1318		CILINDRO AUXILIAR DE EMBREAGEM 38,10mm	1987/...		C-2614	
OF/OH-1318		REPARO DO CIL. MESTRE DE EMBREAGEM 23,81mm	1987/...		C-1615	
OF/OH-1318		REPARO DO CIL. AUXILIAR DE EMBREAGEM 38,10mm	1987/...		C-1616	
OF/OH-1318		VEDANTE DO CILINDRO MESTRE	1987/...		VE-0204	

Tabela de Conversão	Polegadas	9/16"	5/8"	11/16"	7/10"	3/4"	13/16"	7/8"	15/16"	1"	1 1/16"	1 1/8"	1 1/4"	1 3/8"	1 1/2"	1 5/8"	1 3/4"	1 27/32"	2"
	Milímetros	14,28mm	15,87mm	17,46mm	17,78mm	19,05mm	20,63mm	22,22mm	23,81mm	25,40mm	26,98mm	28,57mm	31,75mm	34,92mm	38,10mm	41,27mm	44,45mm	46,83mm	50,80mm

VEÍCULO		DESCRIÇÃO	ANOS	OBSERVAÇÃO	REF.	IMAGEM
<b>MERCEDES BENZ - CAMINHÕES</b>						
OH-1416		CILINDRO MESTRE SIMPLES 34,92mm	1970/1989		C-2159	
OH-1416		REPARO DO CILINDRO MESTRE SIMPLES 34,92mm	1970/1989		C-1070	
OH-1416	<	CILINDRO DE RODA 46,83mm	1970/1989		C-3302	
OH-1416	<<	REPARO DO CILINDRO DE RODA 46,83mm	1970/1989		C-1464	
OH-1416	<<	COPO DO CILINDRO DE RODA 46,83mm	1970/1989		CO-1314	
OH-1416	<<	TAPA-PÓ DO CILINDRO DE RODA	1970/1989		TA-0328	
L/LP/OH-1419		CILINDRO MESTRE DE EMBREAGEM 23,81mm	1980/...		C-2607	
L/LP/OH-1419		CILINDRO AUXILIAR DE EMBREAGEM 38,10mm	1980/...		C-2614	
L/LP/OH-1419		REPARO DO CIL. MESTRE DE EMBREAGEM 23,81mm	1980/...		C-1629	
L/LP/OH-1419		REPARO DO CIL. AUXILIAR DE EMBREAGEM 38,10mm	1980/...		C-1616	
L/LP/OH-1419		VEDANTE DO CILINDRO MESTRE	1980/...		VE-0202	
L/LP/OH-1419		CILINDRO MESTRE SIMPLES 34,92mm	1970/1989		C-2159	
L/LP/OH-1419		REPARO DO CILINDRO MESTRE SIMPLES 34,92mm	1970/1989		C-1070	
L/LP/OH-1419	<	CILINDRO DE RODA 46,83mm	1970/1989		C-3302	
L/LP/OH-1419	<<	REPARO DO CILINDRO DE RODA 46,83mm	1970/1989		C-1464	
L/LP/OH-1419	<<	COPO DO CILINDRO DE RODA 46,83mm	1970/1989		CO-1314	
L/LP/OH-1419	<<	TAPA-PÓ DO CILINDRO DE RODA	1970/1989		TA-0328	
OH-1420		CILINDRO MESTRE DE EMBREAGEM 23,81mm	1980/...		C-2607	
OH-1420		CILINDRO AUXILIAR DE EMBREAGEM 38,10mm	1980/...		C-2614	
OH-1420		REPARO DO CIL. MESTRE DE EMBREAGEM 23,81mm	1980/...		C-1629	
OH-1420		REPARO DO CIL. AUXILIAR DE EMBREAGEM 38,10mm	1980/...		C-1616	
OH-1420		VEDANTE DO CILINDRO MESTRE	1980/...		VE-0202	

BUSCA POR VEÍCULOS

Tabela de Conversão	Polegadas	9/16"	5/8"	11/16"	7/10"	3/4"	13/16"	7/8"	15/16"	1"	1 1/16"	1 1/8"	1 1/4"	1 3/8"	1 1/2"	1 5/8"	1 3/4"	1 27/32"	2"
	Milímetros	14,28mm	15,87mm	17,46mm	17,78mm	19,05mm	20,63mm	22,22mm	23,81mm	25,40mm	26,98mm	28,57mm	31,75mm	34,92mm	38,10mm	41,27mm	44,45mm	46,83mm	50,80mm

VEÍCULO		DESCRIÇÃO	ANOS	OBSERVAÇÃO	REF.	IMAGEM
<b>MERCEDES BENZ - CAMINHÕES</b>						
L/LK-1513/1516		CILINDRO MESTRE SIMPLES 34,92mm	1971/1976		C-2159	
L/LK-1513/1516		REPARO DO CILINDRO MESTRE SIMPLES 34,92mm	1971/1976		C-1070	
L/LK-1513/1516	<-	CILINDRO DE RODA 46,83mm	1971/1989		C-3302	
L/LK-1513/1516	<-	REPARO DO CILINDRO DE RODA 46,83mm	1971/1989		C-1464	
L/LK-1513/1516	<-	COPO DO CILINDRO DE RODA 46,83mm	1971/1989		CO-1314	
L/LK-1513/1516	<-	TAPA-PÓ DO CILINDRO DE RODA	1971/1989		TA-0328	
L/LK-1513/1516	->	CILINDRO DE RODA 50,80mm	1971/1976		C-3303	
L/LK-1513/1516	->	REPARO DO CILINDRO DE RODA 50,80mm	1971/1989		C-1478	
L/LK-1513/1516	->	COPO DO CILINDRO DE RODA 50,80mm	1971/1989		CO-1308	
L/LK-1513/1516	->	TAPA-PÓ DO CILINDRO DE RODA	1971/1989		TA-0308	
OH-1517		REPARO DO CILINDRO MESTRE DUPL0 38,10mm	1970/1976		C-1078	
OH-1517	<-	CILINDRO DE RODA 46,83mm	1970/1989		C-3302	
OH-1517	<-	REPARO DO CILINDRO DE RODA 46,83mm	1970/1989		C-1464	
OH-1517	<-	COPO DO CILINDRO DE RODA 46,83mm	1970/1989		CO-1314	
OH-1517	<-	TAPA-PÓ DO CILINDRO DE RODA	1970/1989		TA-0328	
OH-1517	->	CILINDRO DE RODA 50,80mm	1970/1976		C-3303	
OH-1517	->	REPARO DO CILINDRO DE RODA 50,80mm	1970/1989		C-1478	
OH-1517	->	COPO DO CILINDRO DE RODA 50,80mm	1970/1989		CO-1308	
OH-1517	->	TAPA-PÓ DO CILINDRO DE RODA	1970/1989		TA-0308	
L-1519		CILINDRO MESTRE SIMPLES 34,92mm	1973/1976		C-2159	
L-1519		REPARO DO CILINDRO MESTRE SIMPLES 34,92mm	1973/1976		C-1070	
L-1519	<-	CILINDRO DE RODA 46,83mm	1973/1990		C-3302	
L-1519	<-	REPARO DO CILINDRO DE RODA 46,83mm	1973/1990		C-1464	
L-1519	<-	COPO DO CILINDRO DE RODA 46,83mm	1973/1990		CO-1314	
L-1519	<-	TAPA-PÓ DO CILINDRO DE RODA	1973/1990		TA-0328	

Tabela de Conversão	Polegadas	9/16"	5/8"	11/16"	7/10"	3/4"	13/16"	7/8"	15/16"	1"	1 1/16"	1 1/8"	1 1/4"	1 3/8"	1 1/2"	1 5/8"	1 3/4"	1 27/32"	2"
	Milímetros	14,28mm	15,87mm	17,46mm	17,78mm	19,05mm	20,63mm	22,22mm	23,81mm	25,40mm	26,98mm	28,57mm	31,75mm	34,92mm	38,10mm	41,27mm	44,45mm	46,83mm	50,80mm

VEÍCULO		DESCRIÇÃO	ANOS	OBSERVAÇÃO	REF.	IMAGEM
<b>MERCEDES BENZ - CAMINHÕES</b>						
L-1519	->	CILINDRO DE RODA 50,80mm	1973/1976		C-3303	
L-1519	->	REPARO DO CILINDRO DE RODA 50,80mm	1973/1990		C-1478	
L-1519	->	COPO DO CILINDRO DE RODA 50,80mm	1973/1990		CO-1308	
L-1519	->	TAPA-PÓ DO CILINDRO DE RODA	1973/1990		TA-0308	
L/LP-1614		CILINDRO MESTRE DE EMBREAGEM 23,81mm	1989/...		C-2607	
L/LP-1614		CILINDRO AUXILIAR DE EMBREAGEM 38,10mm	1989/...		C-2614	
L/LP-1614		REPARO DO CIL. MESTRE DE EMBREAGEM 23,81mm	1989/...		C-1629	
L/LP-1614		REPARO DO CIL. AUXILIAR DE EMBREAGEM 38,10mm	1989/...		C-1616	
L/LP-1614		VEDANTE DO CILINDRO MESTRE	1989/...		VE-0202	
L/LK-1618		CILINDRO MESTRE DE EMBREAGEM 23,81mm	1989/...		C-2607	
L/LK-1618		CILINDRO AUXILIAR DE EMBREAGEM 38,10mm	1989/...		C-2614	
L/LK-1618		REPARO DO CIL. MESTRE DE EMBREAGEM 23,81mm	1989/...		C-1629	
L/LK-1618		REPARO DO CIL. AUXILIAR DE EMBREAGEM 38,10mm	1989/...		C-1616	
L/LK-1618		VEDANTE DO CILINDRO MESTRE	1989/...		VE-0202	
OF-1620		CILINDRO AUXILIAR DE EMBREAGEM 28,57mm	1992/...		C-2611	
OF-1620		REPARO DO CIL. AUXILIAR DE EMBREAGEM 28,57mm	1992/...		C-1621	
L/LK/LS-1621		CILINDRO AUXILIAR DE EMBREAGEM 38,10mm	1989/...		C-2615	
L/LK/LS-1621		REPARO DO CIL. AUXILIAR DE EMBREAGEM 38,10mm	1989/...		C-1628	
L/LS-1625		CILINDRO AUXILIAR DE EMBREAGEM 38,10mm	1991/...		C-2614	
L/LS-1625		REPARO DO CIL. AUXILIAR DE EMBREAGEM 38,10mm	1991/...		C-1616	
LF1634		CILINDRO MESTRE DE EMBREAGEM 20,64mm	TODOS		C-2689	

Tabela de Conversão	Polegadas	9/16"	5/8"	11/16"	7/10"	3/4"	13/16"	7/8"	15/16"	1"	1 1/16"	1 1/8"	1 1/4"	1 3/8"	1 1/2"	1 5/8"	1 3/4"	1 27/32"	2"
	Milímetros	14,28mm	15,87mm	17,46mm	17,78mm	19,05mm	20,63mm	22,22mm	23,81mm	25,40mm	26,98mm	28,57mm	31,75mm	34,92mm	38,10mm	41,27mm	44,45mm	46,83mm	50,80mm

VEÍCULO		DESCRIÇÃO	ANOS	OBSERVAÇÃO	REF.	IMAGEM
<b>MERCEDES BENZ - CAMINHÕES</b>						
LS-1630/1635		CILINDRO MESTRE DE EMBREAGEM 19,05mm	1991/...		C-2602	
LS-1630/1635		CILINDRO AUXILIAR DE EMBREAGEM 28,57mm	1991/...		C-2611	
LS-1630/1635		REPARO DO CIL. MESTRE DE EMBREAGEM 19,05mm	1991/...		C-1627	
LS-1630/1635		REPARO DO CIL. AUXILIAR DE EMBREAGEM 28,57mm	1991/...		C-1621	
LS-1630/1635		VEDANTE DO CILINDRO MESTRE	1991/...		VE-0202	
L-1714		CILINDRO AUXILIAR DE EMBREAGEM 38,10mm	1991/...		C-2614	
L-1714		REPARO DO CIL. AUXILIAR DE EMBREAGEM 38,10mm	1991/...		C-1616	
OF-1417		MANGUEIRA DO FILTRO DE AR			C-9036	
OF-1721		CILINDRO MESTRE DE EMBREAGEM 20,63mm	2000/...		C-2655	
OF-1721		REPARO DO CIL. MESTRE DE EMBREAGEM 20,63mm	2000/...		C-1645	
OF-1721		MANGUEIRA DO FILTRO DE AR			C-9036	
OF-1722		MANGUEIRA DO FILTRO DE AR			C-9036	
OF-1723		MANGUEIRA DO FILTRO DE AR			C-9036	
OF-1724		MANGUEIRA DO FILTRO DE AR			C-9036	
L/LS/LK-1929		CILINDRO MESTRE DE EMBREAGEM 19,05mm	1991/...	MOD. L/LS	C-2602	
L/LS/LK-1929		CILINDRO MESTRE DE EMBREAGEM 20,63mm	1992/...		C-2621	
L/LS/LK-1929		REPARO DO CIL. MESTRE DE EMBREAGEM 19,05mm	1991/...	MOD. L/LS	C-1627	
L/LS/LK-1929		REPARO DO CIL. MESTRE DE EMBREAGEM 20,63mm	1992/...		C-1624	
L/LS/LK-1929		VEDANTE DO CILINDRO MESTRE	1990/...		VE-0202	
L/LS-1932/1933/1934		CILINDRO MESTRE DE EMBREAGEM 19,05mm	1984/...	MOD. L/LS	C-2601	
L/LS-1932/1933/1934		REPARO DO CIL. MESTRE DE EMBREAGEM 19,05mm	1984/...	MOD. L/LS	C-1626	
L/LS-1932/1933/1934		VEDANTE DO CILINDRO MESTRE	1984/...	MOD. L/LS	VE-0202	
L/LS/LK-1935		CILINDRO MESTRE DE EMBREAGEM 19,05mm	1991/...	MOD. L/LS	C-2602	









Tabela de Conversão	Polegadas	9/16"	5/8"	11/16"	7/10"	3/4"	13/16"	7/8"	15/16"	1"	1 1/16"	1 1/8"	1 1/4"	1 3/8"	1 1/2"	1 5/8"	1 3/4"	1 27/32"	2"
	Milímetros	14,28mm	15,87mm	17,46mm	17,78mm	19,05mm	20,63mm	22,22mm	23,81mm	25,40mm	26,98mm	28,57mm	31,75mm	34,92mm	38,10mm	41,27mm	44,45mm	46,83mm	50,80mm

VEÍCULO		DESCRIÇÃO	ANOS	OBSERVAÇÃO	REF.	IMAGEM
<b>MERCEDES BENZ - CAMINHÕES</b>						
L/LS/LK-1935		CILINDRO MESTRE DE EMBREAGEM 20,63mm	1992/...		C-2621	
L/LS/LK-1935		REPARO DO CIL. MESTRE DE EMBREAGEM 19,05mm	1990/1991		C-1617	
L/LS/LK-1935		REPARO DO CIL. MESTRE DE EMBREAGEM 19,05mm	1991/...	MOD. L/LS	C-1627	
L/LS/LK-1935		REPARO DO CIL. MESTRE DE EMBREAGEM 20,63mm	1992/...		C-1624	
L/LS/LK-1935		VEDANTE DO CILINDRO MESTRE	1990/...		VE-0202	
LS-1938		CILINDRO MESTRE DE EMBREAGEM 19,05mm	1991/...		C-2602	
LS-1938		CILINDRO AUXILIAR DE EMBREAGEM 28,57mm	1991/...		C-2611	
LS-1938		REPARO DO CIL. MESTRE DE EMBREAGEM 19,05mm	1991/...		C-1627	
LS-1938		REPARO DO CIL. AUXILIAR DE EMBREAGEM 28,57mm	1991/...		C-1621	
LS-1938		VEDANTE DO CILINDRO MESTRE	1991/...		VE-0202	
L/LS/LK-1941		CILINDRO MESTRE DE EMBREAGEM 19,05mm	1991/...	MOD. L/LS	C-2602	
L/LS/LK-1941		CILINDRO MESTRE DE EMBREAGEM 20,63mm	1992/...		C-2621	
L/LS/LK-1941		CILINDRO AUXILIAR DE EMBREAGEM 28,57mm	1991/1991	MOD. L/LS	C-2611	
L/LS/LK-1941		REPARO DO CIL. MESTRE DE EMBREAGEM 19,05mm	1991/...	MOD. L/LS	C-1627	
L/LS/LK-1941		REPARO DO CIL. MESTRE DE EMBREAGEM 20,63mm	1992/...		C-1624	
L/LS/LK-1941		REPARO DO CIL. AUXILIAR DE EMBREAGEM 28,57mm	1991/1991	MOD. L/LS	C-1621	
L/LS/LK-1941		VEDANTE DO CILINDRO MESTRE	1990/...		VE-0202	
L-2013	<	CILINDRO DE RODA 46,83mm	1973/1989		C-3302	
L-2013	<	REPARO DO CILINDRO DE RODA 46,83mm	1973/1989		C-1464	
L-2013	<	COPO DO CILINDRO DE RODA 46,83mm	1973/1989		CO-1314	
L-2013	<	TAPA-PÓ DO CILINDRO DE RODA	1973/1989		TA-0328	
L-2013	>	CILINDRO DE RODA 50,80mm	1973/1976		C-3303	
L-2013	>	CILINDRO DE RODA 44,45mm	1974/1989	TERCEIRO EIXO	C-3301	

Tabela de Conversão	Polegadas	9/16"	5/8"	11/16"	7/10"	3/4"	13/16"	7/8"	15/16"	1"	1 1/16"	1 1/8"	1 1/4"	1 3/8"	1 1/2"	1 5/8"	1 3/4"	1 27/32"	2"
	Milímetros	14,28mm	15,87mm	17,46mm	17,78mm	19,05mm	20,63mm	22,22mm	23,81mm	25,40mm	26,98mm	28,57mm	31,75mm	34,92mm	38,10mm	41,27mm	44,45mm	46,83mm	50,80mm

VEÍCULO		DESCRIÇÃO	ANOS	OBSERVAÇÃO	REF.	IMAGEM
<b>MERCEDES BENZ - CAMINHÕES</b>						
L-2013	->	REPARO DO CILINDRO DE RODA 50,80mm	1973/1976		C-1478	
L-2013	->	REPARO DO CILINDRO DE RODA 44,45mm	1974/1989	TERCEIRO EIXO	C-1454	
L-2013	->	REPARO DO CILINDRO DE RODA 44,45mm	1977/1989		C-1454	
L-2013	->	COPO DO CILINDRO DE RODA 50,80mm	1973/1976		CO-1308	
L-2013	->	COPO DO CILINDRO DE RODA 44,45mm	1974/1989	TERCEIRO EIXO	CO-1303	
L-2013	->	COPO DO CILINDRO DE RODA 44,45mm	1977/1989		CO-1303	
L-2013	->	TAPA-PÓ DO CILINDRO DE RODA	1973/1976		TA-0308	
L-2013	->	TAPA-PÓ DO CILINDRO DE RODA	1974/1989	TERCEIRO EIXO	TA-0328	
L-2013	->	TAPA-PÓ DO CILINDRO DE RODA	1977/1989		TA-0328	
L/LB/LK-2213		CILINDRO MESTRE SIMPLES 34,92mm	1973/1990		C-2159	
L/LB/LK-2213		REPARO DO CILINDRO MESTRE SIMPLES 34,92mm	1973/1990		C-1070	
L/LB/LK-2213	<-	CILINDRO DE RODA 46,83mm	1973/1990		C-3302	
L/LB/LK-2213	<-	REPARO DO CILINDRO DE RODA 46,83mm	1973/1990		C-1464	
L/LB/LK-2213	<-	COPO DO CILINDRO DE RODA 46,83mm	1973/1990		CO-1314	
L/LB/LK-2213	<-	TAPA-PÓ DO CILINDRO DE RODA	1973/1990		TA-0328	
L/LB/LK-2213	->	REPARO DO CILINDRO DE RODA 44,45mm	1973/1990		C-1454	
L/LB/LK-2213	->	COPO DO CILINDRO DE RODA 44,45mm	1973/1990		CO-1303	
L/LB/LK-2213	->	TAPA-PÓ DO CILINDRO DE RODA	1973/1990		TA-0328	
C-2423 B/K		CILINDRO MESTRE DE EMBREAGEM 20,63mm	2000/...		C-2655	
C-2423 B/K		REPARO DO CIL. MESTRE DE EMBREAGEM 20,63mm	2000/...		C-1645	
AXOR 2035		MANGUEIRA DO FILTRO DE AR			C-9035	
AXOR 2040		MANGUEIRA DO FILTRO DE AR			C-9035	
AXOR 2535		MANGUEIRA DO FILTRO DE AR			C-9035	
AXOR 2540		MANGUEIRA DO FILTRO DE AR			C-9035	
AXOR 2644		MANGUEIRA DO FILTRO DE AR			C-9035	
AXOR 2536		MANGUEIRA DO FILTRO DE AR			C-9035	
AXOR 2640		MANGUEIRA DO FILTRO DE AR			C-9035	
AXOR 3340		MANGUEIRA DO FILTRO DE AR			C-9035	
AXOR 3344		MANGUEIRA DO FILTRO DE AR			C-9035	
710		CILINDRO MESTRE DE EMBREAGEM 20,64mm	TODOS		C-2689	
712		CILINDRO MESTRE DE EMBREAGEM 20,64mm	TODOS		C-2689	
1218		CILINDRO MESTRE DE EMBREAGEM 20,64mm	TODOS		C-2689	

Tabela de Conversão	Polegadas	9/16"	5/8"	11/16"	7/10"	3/4"	13/16"	7/8"	15/16"	1"	1 1/16"	1 1/8"	1 1/4"	1 3/8"	1 1/2"	1 5/8"	1 3/4"	1 27/32"	2"
	Milímetros	14,28mm	15,87mm	17,46mm	17,78mm	19,05mm	20,63mm	22,22mm	23,81mm	25,40mm	26,98mm	28,57mm	31,75mm	34,92mm	38,10mm	41,27mm	44,45mm	46,83mm	50,80mm

VEÍCULO		DESCRIÇÃO	ANOS	OBSERVAÇÃO	REF.	IMAGEM
<b>MERCEDES BENZ - CAMINHÕES</b>						
1318		CILINDRO MESTRE DE EMBREAGEM 20,64mm	TODOS		C-2689	
1620		CILINDRO MESTRE DE EMBREAGEM 20,64mm	TODOS		C-2689	
<b>MITSUBISHI</b>						
ASX		MANGUEIRA DO FILTRO DE AR	.../2011		C-9030	
L200		CILINDRO MESTRE DE EMBREAGEM 15,87mm	2003/2012	HPE/SPORT/OUTDOOR	C-2652	
L200		CILINDRO AUXILIAR DE EMBREAGEM 19,05mm	1992/2006	L/GL/GLS	C-2664	
L200		SERVO FREIO 230mm	1992/2006	L/GL/GLS	C-5663	
L200		CILINDRO MESTRE DUPLO 23,81mm C/ RESERV.	1992/2006	L/GL/GLS	C-2131	
L200		CILINDRO MESTRE DUPLO 23,81mm C/RESERV.	2003/...	SPORT/AUTOMÁTICA	C-2179	
L200		CILINDRO MESTRE DUPLO 23,81mm C/ RESERV.	2003/2012	HPE/SPORT/OUTDOOR S/ABS	C-2131	
L200	<	REPARO DE VEDAÇÃO DA PINÇA 57,00mm	1992/2006	L/GL/GLS	C-1448	
L200	>	CILINDRO DE RODA ESQUERDA 22,22mm	1992/2006	L/GL/GLS 4X4	C-3498	
L200	>	CILINDRO DE RODA DIREITA 22,22mm	1992/2006	L/GL/GLS 4X4	C-3499	

BUSCA POR VEÍCULOS

Tabela de Conversão	Polegadas	9/16"	5/8"	11/16"	7/10"	3/4"	13/16"	7/8"	15/16"	1"	1 1/16"	1 1/8"	1 1/4"	1 3/8"	1 1/2"	1 5/8"	1 3/4"	1 27/32"	2"
	Milímetros	14,28mm	15,87mm	17,46mm	17,78mm	19,05mm	20,63mm	22,22mm	23,81mm	25,40mm	26,98mm	28,57mm	31,75mm	34,92mm	38,10mm	41,27mm	44,45mm	46,83mm	50,80mm



VEÍCULO		DESCRIÇÃO	ANOS	OBSERVAÇÃO	REF.	IMAGEM
<b>MITSUBISHI</b>						
L200	->	CILINDRO DE RODA ESQUERDA 23,81mm	2003/2012	HPE/SPORT/OUTDOOR	C-3528	
L200	->	CILINDRO DE RODA DIREITA 23,81mm	2003/2012	HPE/SPORT/OUTDOOR	C-3529	
L200	->	REPARO DO CILINDRO DE RODA 22,22mm	1992/2006	L/GL/GLS 4X4	C-1544	
L200	->	GAXETA DO CILINDRO DE RODA 22,22mm	1992/2006	L/GL/GLS 4X4	GA-0316	
L200	->	TAPA-PÓ DO CILINDRO DE RODA	1992/2006	L/GL/GLS 4X4	TA-0396	
L200 TRITON		CILINDRO MESTRE DE EMBREAGEM 19,05mm	2007/2011		C-2675	
L200 TRITON	->	CILINDRO DE RODA 22,22mm	2008/...		C-3455	
L300	<-	REPARO DE VEDAÇÃO DA PINÇA 57,00mm	1995/1999		C-1448	
LANCER		MANGUEIRA DO FILTRO DE AR	2012/...		C-9030	
PAJERO		CILINDRO MESTRE DUPLA 23,81mm C/ RESERV.	1992/2005	S/ABS	C-2131	
PAJERO		CILINDRO MESTRE DUPLA 23,81mm C/RESERV.	2006/...	SPORT HPE/DIESEL	C-2179	
PAJERO	->	CILINDRO DE RODA ESQUERDA 22,22mm	1994/1997	MOTOR 2.8 DIESEL 4X4	C-3498	
PAJERO	->	CILINDRO DE RODA DIREITA 22,22mm	1994/1997	MOTOR 2.8 DIESEL 4X4	C-3499	
PAJERO	->	CILINDRO DE RODA ESQUERDA 23,81mm	1994/1997	MOTOR 2.8 TURBODIESEL	C-3528	

Tabela de Conversão	Polegadas	9/16"	5/8"	11/16"	7/10"	3/4"	13/16"	7/8"	15/16"	1"	1 1/16"	1 1/8"	1 1/4"	1 3/8"	1 1/2"	1 5/8"	1 3/4"	1 7/8"	2"
	Milímetros	14,28mm	15,87mm	17,46mm	17,78mm	19,05mm	20,63mm	22,22mm	23,81mm	25,40mm	26,98mm	28,57mm	31,75mm	34,92mm	38,10mm	41,27mm	44,45mm	46,83mm	50,80mm

VEÍCULO		DESCRIÇÃO	ANOS	OBSERVAÇÃO	REF.	IMAGEM
<b>MITSUBISHI</b>						
PAJERO	->	CILINDRO DE RODA DIREITA 23,81mm	1994/1997	MOTOR 2.8 TURBODIESEL	C-3529	
PAJERO	->	REPARO DO CILINDRO DE RODA 22,22mm	1994/1997	MOTOR 2.8 DIESEL 4X4	C-1544	
PAJERO	->	GAXETA DO CILINDRO DE RODA 22,22mm	1994/1997	MOTOR 2.8 DIESEL 4X4	GA-0316	
PAJERO	->	TAPA-PÓ DO CILINDRO DE RODA	1994/1997	MOTOR 2.8 DIESEL 4X4	TA-0396	
PAJERO TR4	->	CILINDRO DE RODA 22,22mm	2003/...		C-3443	
PAJERO TR4		MANGUEIRA DO FILTRO DE AR	2003/...		C-9031	
<b>NISSAN</b>						
FRONTIER		CIL. ATUADOR CONCÊNTRICO DE EMBREAGEM	1998/2007		C-2708	
FRONTIER	->	CILINDRO DE RODA 20,63mm	2003/2007		C-3530	
FRONTIER	->	CILINDRO DE RODA 22,22mm	2008/...		C-3536	
GRAND LIVINA	->	CILINDRO DE RODA 19,05mm	2010/...		C-3423	
LIVINA		CIL. ATUADOR CONCÊNTRICO DE EMBREAGEM	2011/...	1.6 16V	C-2713	
MARCH		CIL. ATUADOR CONCÊNTRICO DE EMBREAGEM	2011/...	1.6 16V	C-2713	
SENTRA	->	CILINDRO DE RODA 19,05mm	2007/...		C-3423	
TIIDA		CIL. ATUADOR CONCÊNTRICO DE EMBREAGEM	2011/...	1.6 16V	C-2713	
TIIDA	->	CILINDRO DE RODA 19,05mm	2008/...	S/ABS	C-3423	

BUSCA POR VEÍCULOS

Tabela de Conversão	Polegadas	9/16"	5/8"	11/16"	7/10"	3/4"	13/16"	7/8"	15/16"	1"	1 1/16"	1 1/8"	1 1/4"	1 3/8"	1 1/2"	1 5/8"	1 3/4"	1 27/32"	2"
	Milímetros	14,28mm	15,87mm	17,46mm	17,78mm	19,05mm	20,63mm	22,22mm	23,81mm	25,40mm	26,98mm	28,57mm	31,75mm	34,92mm	38,10mm	41,27mm	44,45mm	46,83mm	50,80mm

VEÍCULO		DESCRIÇÃO	ANOS	OBSERVAÇÃO	REF.	IMAGEM
<b>NISSAN</b>						
VERSA		CIL. ATUADOR CONCÊNTRICO DE EMBREAGEM	2011/...	1.6 16V	C-2713	
XTERRA		CIL. ATUADOR CONCÊNTRICO DE EMBREAGEM	2003/2008		C-2708	
<b>PEUGEOT</b>						
106		CILINDRO MESTRE DUPLO 20,63mm	1994/1996	S/ABS	C-2065	
106		REPARO DO CILINDRO MESTRE DUPLO 20,63mm	1994/1996	C/ CIL. CONTROL	C-1165	
106		VEDANTE DO CILINDRO MESTRE	1994/2001		VE-0204	
106	<-	REPARO DE VEDAÇÃO DA PINÇA 48,00mm	1992/2001	SIST. ATE	C-1443	
106	->	CILINDRO DE RODA 19,05mm	1994/1996	C/ABS	C-3519	
106	->	CILINDRO DE RODA 20,63mm	1997/1998	C/ABS	C-3478	
106	->	CILINDRO DE RODA 20,63mm	1999/2001	C/ABS	C-3535	
106	->	REPARO DO CILINDRO DE RODA 20,63mm	1997/1998	C/ABS	C-1578	
106	->	GAXETA DO CILINDRO DE RODA 20,63mm	1997/1998	C/ABS	GA-0206	
106	->	TAPA-PÓ DO CILINDRO DE RODA	1997/1998	C/ABS	TA-0312	
205		CILINDRO MESTRE DUPLO 20,63mm	1992/1998		C-2065	
205		REPARO DO CILINDRO MESTRE DUPLO 20,63mm	1992/1998	C/ CIL. CONTROL	C-1165	
205		VEDANTE DO CILINDRO MESTRE	1992/1998		VE-0204	
205	<-	REPARO DE VEDAÇÃO DA PINÇA 48,00mm	1992/1998	SIST. ATE	C-1443	
206		SERVO FREIO 230mm	1999/2001	MOTOR 1.6 8V S/ABS	C-5664	
206		SERVO FREIO 230mm	2001/2004	MOTOR 1.0 16V	C-5664	

Tabela de Conversão	Polegadas	9/16"	5/8"	11/16"	7/10"	3/4"	13/16"	7/8"	15/16"	1"	1 1/16"	1 1/8"	1 1/4"	1 3/8"	1 1/2"	1 5/8"	1 3/4"	1 27/32"	2"
	Milímetros	14,28mm	15,87mm	17,46mm	17,78mm	19,05mm	20,63mm	22,22mm	23,81mm	25,40mm	26,98mm	28,57mm	31,75mm	34,92mm	38,10mm	41,27mm	44,45mm	46,83mm	50,80mm

VEÍCULO		DESCRIÇÃO	ANOS	OBSERVAÇÃO	REF.	IMAGEM
<b>PEUGEOT</b>						
206		SERVO FREIO 230mm	2001/2008	MOTOR 1.6 16V	C-5670	
206		SERVO FREIO 230mm	2005/2010	MOTOR 1.4 8V	C-5664	
206		CILINDRO MESTRE DUPL0 20,63mm	1999/2001	MOTOR 1.6 8V S/ABS	C-2130	
206		CILINDRO MESTRE DUPL0 20,63mm	2001/2004	MOTOR 1.0 16V S/ABS	C-2130	
206		CILINDRO MESTRE DUPL0 22,22mm	2001/2008	MOTOR 1.6 16V S/ABS	C-2138	
206		CILINDRO MESTRE DUPL0 20,63mm	2005/2010	MOTOR 1.4 8V S/ABS	C-2130	
206		VEDANTE DO CILINDRO MESTRE	1999/2010		VE-0208	
206	->	CILINDRO DE RODA ESQ. 20,63mm C/ VÁLV. REG.	1999/2010		C-3511	
206	->	CILINDRO DE RODA DIR. 20,63mm C/ VÁLV. REG.	1999/2010		C-3512	
206		JOGO ANÉIS VEDAÇÃO COLETOR DE ADMISSÃO	2001/2004	MOTOR 1.0 16V	C-9508	
206		JOGO ANÉIS VEDAÇÃO COLETOR DE ADMISSÃO	2001/2008	MOTOR 1.6 16V	C-9503	
206 SW		SERVO FREIO 230mm	2005/2008	MOTOR 1.4 8V	C-5664	

BUSCA POR VEÍCULOS

Tabela de Conversão	Polegadas	9/16"	5/8"	11/16"	7/10"	3/4"	13/16"	7/8"	15/16"	1"	1 1/16"	1 1/8"	1 1/4"	1 3/8"	1 1/2"	1 5/8"	1 3/4"	1 27/32"	2"
	Milímetros	14,28mm	15,87mm	17,46mm	17,78mm	19,05mm	20,63mm	22,22mm	23,81mm	25,40mm	26,98mm	28,57mm	31,75mm	34,92mm	38,10mm	41,27mm	44,45mm	46,83mm	50,80mm

VEÍCULO		DESCRIÇÃO	ANOS	OBSERVAÇÃO	REF.	IMAGEM
<b>PEUGEOT</b>						
206 SW		SERVO FREIO 230mm	2005/2008	MOTOR 1.6 16V	C-5670	
206 SW		CILINDRO MESTRE DUPL0 20,63mm	2005/2008	MOTOR 1.4 8V S/ABS	C-2130	
206 SW		CILINDRO MESTRE DUPL0 22,22mm	2005/2008	MOTOR 1.6 16V S/ABS	C-2138	
206 SW		VEDANTE DO CILINDRO MESTRE	2005/2008		VE-0208	
206 SW	<-	REPARO DE VEDAÇÃO DA PINÇA 54,00mm	2003/...		C-1530	
206 SW	->	CILINDRO DE RODA 19,05mm	2005/2008	SIST. BOSCH	C-3519	
206 SW	->	CILINDRO DE RODA 20,63mm	2005/2008	SIST. TRW	C-3535	
206 SW		JOGO ANÉIS VEDAÇÃO COLETOR DE ADMISSÃO	2005/2008	MOTOR 1.6 16V	C-9503	
207		SERVO FREIO 230mm	2009/...	MOTOR 1.4 8V	C-5664	
207		SERVO FREIO 230mm	2009/...	MOTOR 1.6 16V	C-5670	
207		CILINDRO MESTRE DUPL0 20,63mm	2009/...	MOTOR 1.4 8V S/ABS	C-2130	
207		CILINDRO MESTRE DUPL0 22,22mm	2009/...	MOTOR 1.6 16V S/ABS	C-2138	
207		VEDANTE DO CILINDRO MESTRE	2009/...		VE-0208	

Tabela de Conversão	Polegadas	9/16"	5/8"	11/16"	7/10"	3/4"	13/16"	7/8"	15/16"	1"	1 1/16"	1 1/8"	1 1/4"	1 3/8"	1 1/2"	1 5/8"	1 3/4"	1 27/32"	2"
	Milímetros	14,28mm	15,87mm	17,46mm	17,78mm	19,05mm	20,63mm	22,22mm	23,81mm	25,40mm	26,98mm	28,57mm	31,75mm	34,92mm	38,10mm	41,27mm	44,45mm	46,83mm	50,80mm

VEÍCULO		DESCRIÇÃO	ANOS	OBSERVAÇÃO	REF.	IMAGEM
<b>PEUGEOT</b>						
207	->	CILINDRO DE RODA ESQ. 20,63mm C/ VÁLV. REG.	2009/...		C-3511	
207	->	CILINDRO DE RODA DIR. 20,63mm C/ VÁLV. REG.	2009/...		C-3512	
207		JOGO ANÉIS VEDAÇÃO COLETOR DE ADMISSÃO	2009/...	MOTOR 1.6 16V	C-9503	
207 PASSION		SERVO FREIO 230mm	2009/...	MOTOR 1.4 8V	C-5664	
207 PASSION		SERVO FREIO 230mm	2009/...	MOTOR 1.6 16V	C-5670	
207 PASSION		CILINDRO MESTRE DUPLA 20,63mm	2009/...	MOTOR 1.4 8V S/ABS	C-2130	
207 PASSION		CILINDRO MESTRE DUPLA 22,22mm	2009/...	MOTOR 1.6 16V S/ABS	C-2138	
207 PASSION		VEDANTE DO CILINDRO MESTRE	2009/...		VE-0208	
207 PASSION	->	CILINDRO DE RODA 20,63mm	2009/...	SIST. TRW	C-3535	
207 PASSION		JOGO ANÉIS VEDAÇÃO COLETOR DE ADMISSÃO	2009/...	MOTOR 1.6 16V	C-9503	
207 SW		SERVO FREIO 230mm	2009/...	MOTOR 1.4 8V	C-5664	
207 SW		SERVO FREIO 230mm	2009/...	MOTOR 1.6 16V	C-5670	

BUSCA POR VEÍCULOS

Tabela de Conversão	Polegadas	9/16"	5/8"	11/16"	7/10"	3/4"	13/16"	7/8"	15/16"	1"	1 1/16"	1 1/8"	1 1/4"	1 3/8"	1 1/2"	1 5/8"	1 3/4"	1 27/32"	2"
	Milímetros	14,28mm	15,87mm	17,46mm	17,78mm	19,05mm	20,63mm	22,22mm	23,81mm	25,40mm	26,98mm	28,57mm	31,75mm	34,92mm	38,10mm	41,27mm	44,45mm	46,83mm	50,80mm

VEÍCULO		DESCRIÇÃO	ANOS	OBSERVAÇÃO	REF.	IMAGEM
<b>PEUGEOT</b>						
207 SW		CILINDRO MESTRE DUPL0 20,63mm	2009/...	MOTOR 1.4 8V S/ABS	C-2130	
207 SW		CILINDRO MESTRE DUPL0 22,22mm	2009/...	MOTOR 1.6 16V S/ABS	C-2138	
207 SW		VEDANTE DO CILINDRO MESTRE	2009/...		VE-0208	
207 SW	->	CILINDRO DE RODA 19,05mm	2009/...	SIST. BOSCH	C-3519	
207 SW	->	CILINDRO DE RODA 20,63mm	2009/...	SIST. TRW	C-3535	
207 SW		JOGO ANÉIS VEDAÇÃO COLETOR DE ADMISSÃO	2009/...	MOTOR 1.6 16V	C-9503	
208		CILINDRO MESTRE DE EMBREAGEM 15,87mm	2012/...	1.5/1.6/1.6 THP	C-2681	
208		CILINDRO AUXILIAR DE EMBREAGEM 19,05mm	2000/...	1.5/1.6/1.6 THP	C-2682	
306		CILINDRO MESTRE DUPL0 20,63mm	1994/1997	SIST. ATE S/ABS	C-2130	
306		CILINDRO MESTRE DUPL0 22,22mm	1998/2002	SIST. ATE S/ABS	C-2138	
306		VEDANTE DO CILINDRO MESTRE	1994/2002		VE-0208	
306	<-	REPARO DE VEDAÇÃO DA PINÇA 48,00mm	1994/2002	SIST. ATE	C-1443	
306	<-	REPARO DE VEDAÇÃO DA PINÇA 54,00mm	1994/2002	SIST. LUCAS	C-1558	
306	<-	TAPA PÓ DO PINO DE GUIA	1994/2002	SIST. GIRLING	TA-0322	
306	->	CILINDRO DE RODA 20,63mm	1994/2002	SIST. LUCAS C/ABS	C-3478	

Tabela de Conversão	Polegadas	9/16"	5/8"	11/16"	7/10"	3/4"	13/16"	7/8"	15/16"	1"	1 1/16"	1 1/8"	1 1/4"	1 3/8"	1 1/2"	1 5/8"	1 3/4"	1 27/32"	2"
	Milímetros	14,28mm	15,87mm	17,46mm	17,78mm	19,05mm	20,63mm	22,22mm	23,81mm	25,40mm	26,98mm	28,57mm	31,75mm	34,92mm	38,10mm	41,27mm	44,45mm	46,83mm	50,80mm

VEÍCULO		DESCRIÇÃO	ANOS	OBSERVAÇÃO	REF.	IMAGEM
<b>PEUGEOT</b>						
306	->	CILINDRO DE RODA ESQ. 20,63mm C/ VÁLV. REG.	1994/2002	SIST. BENDIX S/ABS	C-3511	
306	->	CILINDRO DE RODA DIR. 20,63mm C/ VÁLV. REG.	1994/2002	SIST. BENDIX S/ABS	C-3512	
306	->	CILINDRO DE RODA ESQ. 20,63mm C/ VÁLV. REG.	1994/2002	SIST. LUCAS S/ABS	C-3522	
306	->	CILINDRO DE RODA DIR. 20,63mm C/ VÁLV. REG.	1994/2002	SIST. LUCAS S/ABS	C-3523	
306	->	REPARO DO CILINDRO DE RODA 20,63mm	1994/2002	SIST. LUCAS C/ABS	C-1578	
306	->	GAXETA DO CILINDRO DE RODA 20,63mm	1994/2002	SIST. LUCAS C/ABS	GA-0206	
306	->	TAPA-PÓ DO CILINDRO DE RODA	1994/2002	SIST. LUCAS C/ABS	TA-0312	
306 BREAK		CILINDRO MESTRE DUPLO 23,81mm	1996/2001	S/ABS	C-2171	
306 BREAK	<	REPARO DE VEDAÇÃO DA PINÇA 54,00mm	1997/2002	1.8 16V	C-1530	
307		CILINDRO MESTRE DE EMBREAGEM 15,87mm	2000/...	2.0 16V	C-2685	
307		CILINDRO MESTRE DE EMBREAGEM 15,87mm	2000/...	1.6 16V	C-2686	
307		CILINDRO AUXILIAR DE EMBREAGEM 19,05mm	2000/...	1.6 16V	C-2682	
307		CILINDRO AUXILIAR DE EMBREAGEM 19,05mm	2000/...	2.0 16V	C-2687	
307		CILINDRO MESTRE DUPLO 23,81mm	2000/2006	2.0 16V RALLYE COM ESP	C-2193	
307		CILINDRO MESTRE DUPLO 23,81mm	2001/...	1.6 PASSION COM ESP	C-2193	

BUSCA POR VEÍCULOS

Tabela de Conversão	Polegadas	9/16"	5/8"	11/16"	7/10"	3/4"	13/16"	7/8"	15/16"	1"	1 1/16"	1 1/8"	1 1/4"	1 3/8"	1 1/2"	1 5/8"	1 3/4"	1 27/32"	2"
	Milímetros	14,28mm	15,87mm	17,46mm	17,78mm	19,05mm	20,63mm	22,22mm	23,81mm	25,40mm	26,98mm	28,57mm	31,75mm	34,92mm	38,10mm	41,27mm	44,45mm	46,83mm	50,80mm













VEÍCULO		DESCRIÇÃO	ANOS	OBSERVAÇÃO	REF.	IMAGEM
<b>PEUGEOT</b>						
307		CILINDRO MESTRE DUPLO 23,81mm	2002/2008	SW 2.0 16V COM ESP	C-2193	
307		CILINDRO MESTRE DUPLO 23,81mm	2003/2009	CC 2.0 16V	C-2193	
307		CILINDRO MESTRE DUPLO 23,81mm	2006/...	2.0 16V COM ESP	C-2193	
307		CILINDRO MESTRE DUPLO 23,81mm	2006/2007	1.6 COM ESP	C-2193	
307	<-	REPARO DE VEDAÇÃO DA PINÇA 54,00mm	2000/...	1.6 16V	C-1530	
307	->	REPARO DE VEDAÇÃO DA PINÇA 38,00mm	2001/2012	SIST. TRW	C-1551	
307		JOGO ANÉIS VEDAÇÃO COLETOR DE ADMISSÃO	2001/2012	1.6 16V	C-9503	
308		CILINDRO MESTRE DE EMBREAGEM 15,87mm	2000/...	1.6/2.0 16V	C-2685	
308		CILINDRO AUXILIAR DE EMBREAGEM 19,05mm	2000/...	1.6 / 2.0 16V	C-2687	
405		CILINDRO MESTRE DUPLO 20,63mm	1992/1999	SIST. BENDIX S/ABS	C-2079	
405		REPARO DO CILINDRO MESTRE DUPLO 20,63mm	1992/1999	P/ CILINDROS CONTROL E BENDIX	C-1166	
405		VEDANTE DO CILINDRO MESTRE	1992/1999		VE-0204	
405	<-	REPARO DE VEDAÇÃO DA PINÇA 54,00mm	1992/1999	MOTOR 2.0 SIST. LUCAS	C-1558	
405	->	REPARO DE VEDAÇÃO DA PINÇA 38,00mm	1992/1995		C-1549	
405	->	TAPA PÓ DO PINO DE GUIA	1992/1995		TA-0322	
407	->	REPARO DE VEDAÇÃO DA PINÇA 38,00mm	2004/2009		C-1551	
408		CILINDRO MESTRE DE EMBREAGEM 15,87mm	2000/...	2.0 16V	C-2685	
408		CILINDRO AUXILIAR DE EMBREAGEM 19,05mm	2000/...	2.0 16V	C-2687	
504 PICK-UP	<-	REPARO DE VEDAÇÃO DA PINÇA 54,00mm	1992/1999	SIST. ATE	C-1419	
504 PICK-UP	->	CILINDRO DE RODA 22,22mm	1992/1999	SIST. GIRLING	C-3479	
504 PICK-UP	->	REPARO DO CILINDRO DE RODA 22,22mm	1992/1999	SIST. GIRLING	C-1582	

Tabela de Conversão	Polegadas	9/16"	5/8"	11/16"	7/10"	3/4"	13/16"	7/8"	15/16"	1"	1 1/16"	1 1/8"	1 1/4"	1 3/8"	1 1/2"	1 5/8"	1 3/4"	1 27/32"	2"
	Milímetros	14,28mm	15,87mm	17,46mm	17,78mm	19,05mm	20,63mm	22,22mm	23,81mm	25,40mm	26,98mm	28,57mm	31,75mm	34,92mm	38,10mm	41,27mm	44,45mm	46,83mm	50,80mm

VEÍCULO		DESCRIÇÃO	ANOS	OBSERVAÇÃO	REF.	IMAGEM
<b>PEUGEOT</b>						
504 PICK-UP	->	GAXETA DO CILINDRO DE RODA 22,22mm	1992/1999	SIST. GIRLING	GA-0207	
504 PICK-UP	->	TAPA-PÓ DO CILINDRO DE RODA	1992/1999	SIST. GIRLING	TA-0312	
605	<-	REPARO DE VEDAÇÃO DA PINÇA 57,00mm	1992/2000	MOTOR 3.0 V6	C-1567	
607	->	REPARO DE VEDAÇÃO DA PINÇA 38,00mm	2000/2005		C-1551	
807	->	REPARO DE VEDAÇÃO DA PINÇA 38,00mm	2004/2005		C-1551	
3008	->	REPARO DE VEDAÇÃO DA PINÇA 38,00mm	2011/...		C-1551	
BOXER		CILINDRO MESTRE DUPLA 23,81mm	1998/2002	S/ABS	C-2080	
BOXER		CILINDRO MESTRE DUPLA 25,40mm	2003/...	S/ABS	C-2163	
BOXER		REPARO DO CILINDRO MESTRE DUPLA 23,81mm	1998/2002		C-1167	
BOXER		VEDANTE DO CILINDRO MESTRE	1998/2002		VE-0201	
BOXER	->	CILINDRO DE RODA 26,98mm	1998/2002		C-3486	
BOXER	->	REPARO DO CILINDRO DE RODA 26,98mm	1998/2002		C-1597	
BOXER	->	GAXETA DO CILINDRO DE RODA 26,98mm	1998/2002		GA-0321	
HOGGAR	->	CILINDRO DE RODA 22,22mm	2010/...		C-3505	
HOGGAR	->	REPARO DO CILINDRO DE RODA 22,22mm	2010/...		C-1582	
HOGGAR	->	GAXETA DO CILINDRO DE RODA 22,22mm	2010/...		GA-0207	
HOGGAR	->	TAPA-PÓ DO CILINDRO DE RODA	2010/...		TA-0312	
HOGGAR		JOGO ANÉIS VEDAÇÃO COLETOR DE ADMISSÃO	2010/...	MOTOR 1.6 16V	C-9503	
PARTNER		CILINDRO MESTRE DUPLA 23,81mm	2001/...	S/ABS	C-2171	
PARTNER	<-	REPARO DE VEDAÇÃO DA PINÇA 54,00mm	1997/2000	FURGÃO	C-1530	
PARTNER	<-	REPARO DE VEDAÇÃO DA PINÇA 54,00mm	2001/2002		C-1530	
PARTNER	<-	REPARO DE VEDAÇÃO DA PINÇA 54,00mm	2001/2002	1.8 FURGÃO	C-1530	
PARTNER	->	CILINDRO DE RODA 22,22mm	1999/...		C-3505	
PARTNER	->	REPARO DO CILINDRO DE RODA 22,22mm	1999/...		C-1582	
PARTNER	->	GAXETA DO CILINDRO DE RODA 22,22mm	1999/...		GA-0207	
PARTNER	->	TAPA-PÓ DO CILINDRO DE RODA	1999/...		TA-0312	
928	<-	REPARO DE VEDAÇÃO DA PINÇA 54,00mm	1992/1995		C-1587	

BUSCA POR VEÍCULOS

202

Tabela de Conversão	Polegadas	9/16"	5/8"	11/16"	7/10"	3/4"	13/16"	7/8"	15/16"	1"	1 1/16"	1 1/8"	1 1/4"	1 3/8"	1 1/2"	1 5/8"	1 3/4"	1 27/32"	2"
	Milímetros	14,28mm	15,87mm	17,46mm	17,78mm	19,05mm	20,63mm	22,22mm	23,81mm	25,40mm	26,98mm	28,57mm	31,75mm	34,92mm	38,10mm	41,27mm	44,45mm	46,83mm	50,80mm

VEÍCULO		DESCRIÇÃO	ANOS	OBSERVAÇÃO	REF.	IMAGEM
<b>PUMA</b>						
GT/GTE/GTS		CILINDRO MESTRE SIMPLES 17,46mm	1968/1973		C-2003	
GT/GTE/GTS		REPARO DO CILINDRO MESTRE SIMPLES 17,46mm	1968/1973		C-1048	
GT/GTE/GTS		REPARO DO CILINDRO MESTRE DUPLO 19,05mm	1977/1984		C-1060	
GT/GTE/GTS	<-	CILINDRO DE RODA 22,22mm	1968/1973		C-3351	
GT/GTE/GTS	<-	REPARO DO CILINDRO DE RODA 22,22mm	1968/1973		C-1496	
GT/GTE/GTS	<-	COPO DO CILINDRO DE RODA 22,22mm	1968/1973		CO-1315	
GT/GTE/GTS	<-	TAPA PÓ DO CILINDRO DE RODA	1968/1973		TA-0336	
GT/GTE/GTS	<-	REPARO DE VEDAÇÃO DA PINÇA 40,00mm	1974/1984		C-1498	
GT/GTE/GTS	->	CILINDRO DE RODA 17,46mm	1968/1973		C-3375	
GT/GTE/GTS	->	CILINDRO DE RODA 19,05mm	1974/1976		C-3352	
GT/GTE/GTS	->	CILINDRO DE RODA 22,22mm	1977/1984		C-3357	
GT/GTE/GTS	->	REPARO DO CILINDRO DE RODA 17,46mm	1968/1973		C-1475	
GT/GTE/GTS	->	REPARO DO CILINDRO DE RODA 19,05mm	1974/1976		C-1473	
GT/GTE/GTS	->	REPARO DO CILINDRO DE RODA 22,22mm	1977/1984		C-1496	
GT/GTE/GTS	->	COPO DO CILINDRO DE RODA 17,46mm	1968/1973		CO-1305	
GT/GTE/GTS	->	COPO DO CILINDRO DE RODA 19,05mm	1974/1976		CO-1312	
GT/GTE/GTS	->	COPO DO CILINDRO DE RODA 22,22mm	1977/1984		CO-1315	
GT/GTE/GTS	->	TAPA PÓ DO CILINDRO DE RODA	1968/1976		TA-0329	
GT/GTE/GTS	->	TAPA PÓ DO CILINDRO DE RODA	1977/1984		TA-0336	
GTB		VÁLVULA DE RETENÇÃO DE VÁCUO BRANCA	1974/1980	P/ SERVO FD150	C-1750	
GTB		VÁLVULA DE RETENÇÃO DE VÁCUO	1974/1980		C-1753	
GTB		REPARO DO CILINDRO MESTRE DUPLO 22,22mm	1974/1980		C-1085	
GTB		VEDANTE DO CILINDRO MESTRE	1974/1980		VE-0200	
GTB	<-	REPARO DE VEDAÇÃO DA PINÇA 54,00mm	1974/1980	SIST. VARGA	C-1480	
GTB	<-	REPARO DE VEDAÇÃO DA PINÇA 57,00mm	1979/1980	SIST. ATE	C-1501	
GTB	->	CILINDRO DE RODA ESQUERDA 19,05mm	1974/1978		C-3395	
GTB	->	CILINDRO DE RODA DIREITA 19,05mm	1974/1978		C-3396	
GTB	->	CILINDRO DE RODA ESQUERDA 19,05mm	1979/1980		C-3468	

Tabela de Conversão	Polegadas	9/16"	5/8"	11/16"	7/10"	3/4"	13/16"	7/8"	15/16"	1"	1 1/16"	1 1/8"	1 1/4"	1 3/8"	1 1/2"	1 5/8"	1 3/4"	1 27/32"	2"
	Milímetros		14,28mm	15,87mm	17,46mm	17,78mm	19,05mm	20,63mm	22,22mm	23,81mm	25,40mm	26,98mm	28,57mm	31,75mm	34,92mm	38,10mm	41,27mm	44,45mm	46,83mm

VEÍCULO		DESCRIÇÃO	ANOS	OBSERVAÇÃO	REF.	IMAGEM
<b>PUMA</b>						
GTB	->	CILINDRO DE RODA DIREITA 19,05mm	1979/1980		C-3469	
GTB	->	REPARO DO CILINDRO DE RODA 19,05mm	1974/1980		C-1481	
GTB	->	GAXETA DO CILINDRO DE RODA 19,05mm	1974/1980		GA-0307	
GTB	->	TAPA-PÓ DO CILINDRO DE RODA	1974/1980		TA-0312	
<b>PUMA - CAMINHÕES</b>						
4T		REPARO DO HYDROVAC 9 1/2"	1978/1984		C-1213	
4T		REPARO DO CILINDRO MESTRE SIMPLES 31,75mm	1978/1984		C-1004	
4T	<-	REPARO DO CILINDRO DE RODA 28,57mm	1978/1984		C-1408	
4T	<-	COPO DO CILINDRO DE RODA 28,57mm	1978/1984		CO-1309	
4T	<-	TAPA-PÓ DO CILINDRO DE RODA	1978/1984		TA-0314	
4T	->	REPARO DO CILINDRO DE RODA 31,75mm	1978/1984		C-1412	
4T	->	COPO DO CILINDRO DE RODA 31,75mm	1978/1984		CO-1300	
4T	->	TAPA-PÓ DO CILINDRO DE RODA	1978/1984		TA-0350	
<b>RENAULT</b>						
19		SERVO FREIO 200mm	1992/1998	SIST. VARGA E TEVES	C-5654	
19		VÁLVULA DE RETENÇÃO DE VÁCUO	1992/1998		C-1755	
19		CILINDRO MESTRE DUPLO 20,63mm	1992/1998		C-2065	
19		REPARO DO CILINDRO MESTRE DUPLO 20,63mm	1992/1998	C/ CIL. CONTROLIL/ VARGA	C-1165	
19		VEDANTE DO CILINDRO MESTRE	1992/1998		VE-0204	
19	->	CILINDRO DE RODA ESQUERDA 22,00mm	1992/1998	MOD. RN/RT SIST. VARGA	C-3464	
19	->	CILINDRO DE RODA DIREITA 22,00mm	1992/1998	MOD. RN/RT SIST. VARGA	C-3465	
19	->	CILINDRO DE RODA ESQUERDA 19,00mm	1992/1998	MOD. RT SIST. BENDIX 8"	C-3474	
19	->	CILINDRO DE RODA DIREITA 19,00mm	1992/1998	MOD. RT SIST. BENDIX 8"	C-3475	
19	->	CILINDRO DE RODA ESQ. 20,63mm C/ VÁLV. REG.	1992/1998	MOD. RN SIST. BENDIX 7"	C-3511	

Tabela de Conversão	Polegadas	9/16"	5/8"	11/16"	7/10"	3/4"	13/16"	7/8"	15/16"	1"	1 1/16"	1 1/8"	1 1/4"	1 3/8"	1 1/2"	1 5/8"	1 3/4"	1 27/32"	2"
	Milímetros	14,28mm	15,87mm	17,46mm	17,78mm	19,05mm	20,63mm	22,22mm	23,81mm	25,40mm	26,98mm	28,57mm	31,75mm	34,92mm	38,10mm	41,27mm	44,45mm	46,83mm	50,80mm

VEÍCULO		DESCRIÇÃO	ANOS	OBSERVAÇÃO	REF.	IMAGEM
<b>RENAULT</b>						
19	->	CILINDRO DE RODA DIR. 20,63mm C/ VÁLV. REG.	1992/1998	MOD. RN SIST. BENDIX 7"	C-3512	
19	->	CILINDRO DE RODA ESQ. 20,63mm C/ VÁLV. REG.	1992/1998	MOD. RN SIST. LUCAS	C-3522	
19	->	CILINDRO DE RODA DIR. 20,63mm C/ VÁLV. REG.	1992/1998	MOD. RN SIST. LUCAS	C-3523	
19	->	REPARO DO CILINDRO DE RODA 22,00mm	1992/1998	MOD. RN/RT SIST. VARGA	C-1580	
19	->	REPARO DO CILINDRO DE RODA 19,00mm	1992/1998	MOD. RT SIST. BENDIX 8"	C-1591	
19	->	GAXETA DO CILINDRO DE RODA 19,05mm	1992/1998	MOD. RT SIST. BENDIX 8"	GA-0307	
19	->	GAXETA DO CILINDRO DE RODA 22,00mm	1992/1998	MOD. RN/RT SIST. VARGA	GA-0319	
19	->	TAPA-PÓ DO CILINDRO DE RODA	1992/1998	MOD. RN/RT SIST. VARGA	TA-0310	
19	->	TAPA-PÓ DO CILINDRO DE RODA	1992/1998	MOD. RT SIST. BENDIX 8"	TA-0367	
21	->	CILINDRO DE RODA ESQUERDA 22,22mm	1992/1994	SIST. LUCAS	C-3476	
21	->	CILINDRO DE RODA DIREITA 22,22mm	1992/1994	SIST. LUCAS	C-3477	
21	->	REPARO DO CILINDRO DE RODA 22,22mm	1992/1994	SIST. LUCAS	C-1582	
21	->	GAXETA DO CILINDRO DE RODA 22,22mm	1992/1994	SIST. LUCAS	GA-0207	
21	->	TAPA-PÓ DO CILINDRO DE RODA	1992/1994	SIST. LUCAS	TA-0312	
21 NEVADA	->	CILINDRO DE RODA ESQUERDA 22,22mm	1993/1994	SIST. LUCAS	C-3476	
21 NEVADA	->	CILINDRO DE RODA DIREITA 22,22mm	1993/1994	SIST. LUCAS	C-3477	
21 NEVADA	->	REPARO DO CILINDRO DE RODA 22,22mm	1993/1994	SIST. LUCAS	C-1582	
21 NEVADA	->	GAXETA DO CILINDRO DE RODA 22,22mm	1993/1994	SIST. LUCAS	GA-0207	
21 NEVADA	->	TAPA-PÓ DO CILINDRO DE RODA	1993/1994	SIST. LUCAS	TA-0312	
CLIO		SERVO FREIO 200mm	1996/1999	SIST. VARGA, BENDIX E ATE	C-5655	
CLIO		SERVO FREIO 230mm	2000/...	S/ABS	C-5662	

Tabela de Conversão	Polegadas	9/16"	5/8"	11/16"	7/10"	3/4"	13/16"	7/8"	15/16"	1"	1 1/16"	1 1/8"	1 1/4"	1 3/8"	1 1/2"	1 5/8"	1 3/4"	1 27/32"	2"
	Milímetros	14,28mm	15,87mm	17,46mm	17,78mm	19,05mm	20,63mm	22,22mm	23,81mm	25,40mm	26,98mm	28,57mm	31,75mm	34,92mm	38,10mm	41,27mm	44,45mm	46,83mm	50,80mm

VEÍCULO		DESCRIÇÃO	ANOS	OBSERVAÇÃO	REF.	IMAGEM
<b>RENAULT</b>						
CLIO		VÁLVULA DE RETENÇÃO DE VÁCUO	1996/1999		C-1755	
CLIO		CILINDRO MESTRE DUPLA 20,63mm	1996/1999		C-2065	
CLIO		CILINDRO MESTRE DUPLA 20,63mm	2000/...	S/ABS	C-2096	
CLIO		REPARO DO CILINDRO MESTRE DUPLA 20,63mm	1996/1999	C/ CIL. CONTROLIL/VARGA	C-1165	
CLIO		REPARO DO CILINDRO MESTRE DUPLA 20,63mm	2000/...	S/ABS C/CIL. EM FERRO	C-1174	
CLIO		VEDANTE DO CILINDRO MESTRE	1996/...		VE-0204	
CLIO	<	REPARO DE VEDAÇÃO DA PINÇA 48,00mm	2000/...	SIST. VARGA	C-1413	
CLIO	->	CILINDRO DE RODA ESQUERDA 22,00mm	1996/1999		C-3464	
CLIO	->	CILINDRO DE RODA DIREITA 22,00mm	1996/1999		C-3465	
CLIO	->	CILINDRO DE RODA 17,78mm	2000/2009		C-3490	
CLIO	->	CILINDRO DE RODA 17,46mm	2010/2013		C-3537	
CLIO	->	REPARO DO CILINDRO DE RODA 22,00mm	1996/1999		C-1580	
CLIO	->	REPARO DO CILINDRO DE RODA 17,78mm	2000/2009		C-1566	
CLIO	->	GAXETA DO CILINDRO DE RODA 22,00mm	1996/1999		GA-0319	
CLIO	->	GAXETA DO CILINDRO DE RODA 17,78mm	2000/2009		GA-0301	
CLIO	->	TAPA-PÓ DO CILINDRO DE RODA	1996/1999		TA-0310	
CLIO	->	TAPA-PÓ DO CILINDRO DE RODA	2000/2009		TA-0312	
DUSTER		CIL. ATUADOR CONCÊNTRICO DE EMBREAGEM	2011/2012	1.6 16v	C-2714	
DUSTER	->	CILINDRO DE RODA 19,05mm	2012/...	4x2	C-3431	
EXPRESS		CILINDRO MESTRE DUPLA 20,63mm	1998/2000		C-2065	

BUSCA POR VEÍCULOS

Tabela de Conversão	Polegadas	9/16"	5/8"	11/16"	7/10"	3/4"	13/16"	7/8"	15/16"	1"	1 1/16"	1 1/8"	1 1/4"	1 3/8"	1 1/2"	1 5/8"	1 3/4"	1 27/32"	2"
	Milímetros	14,28mm	15,87mm	17,46mm	17,78mm	19,05mm	20,63mm	22,22mm	23,81mm	25,40mm	26,98mm	28,57mm	31,75mm	34,92mm	38,10mm	41,27mm	44,45mm	46,83mm	50,80mm

VEÍCULO		DESCRIÇÃO	ANOS	OBSERVAÇÃO	REF.	IMAGEM
<b>RENAULT</b>						
EXPRESS		REPARO DO CILINDRO MESTRE DUPL0 20,63mm	1998/2000	C/ CIL. CONTROL/ VARGA	C-1165	
EXPRESS		VEDANTE DO CILINDRO MESTRE	1998/2000		VE-0204	
EXPRESS	->	CILINDRO DE RODA 22,22mm	1998/2000		C-3479	
EXPRESS	->	REPARO DO CILINDRO DE RODA 22,22mm	1998/2000		C-1582	
EXPRESS	->	GAXETA DO CILINDRO DE RODA 22,22mm	1998/2000		GA-0207	
EXPRESS	->	TAPA-PÓ DO CILINDRO DE RODA	1998/2000		TA-0312	
GRAND SCENIC	->	REPARO DE VEDAÇÃO DA PINÇA 38,00mm	2008/2009		C-1551	
KANGOO		CIL. ATUADOR CONCÊNTRICO DE EMBREAGEM	1999/2006	CONECTOR CINZA	C-2714	
KANGOO		CILINDRO MESTRE DUPL0 22,22mm	2000/...	S/ABS	C-2165	
KANGOO	->	CILINDRO DE RODA 22,00mm	2000/...		C-3526	
LAGUNA	->	CILINDRO DE RODA 20,63mm	1999/2001		C-3478	
LAGUNA	->	REPARO DO CILINDRO DE RODA 20,63mm	1999/2001		C-1578	
LAGUNA	->	GAXETA DO CILINDRO DE RODA 20,63mm	1999/2001		GA-0206	
LAGUNA	->	TAPA-PÓ DO CILINDRO DE RODA	1999/2001		TA-0312	
LAGUNA NEVADA	->	CILINDRO DE RODA 20,63mm	1995/1998		C-3478	
LAGUNA NEVADA	->	REPARO DO CILINDRO DE RODA 20,63mm	1995/1998		C-1578	
LAGUNA NEVADA	->	GAXETA DO CILINDRO DE RODA 20,63mm	1995/1998		GA-0206	
LAGUNA NEVADA	->	TAPA-PÓ DO CILINDRO DE RODA	1995/1998		TA-0312	
LOGAN		SERVO FREIO 230mm	2007/2011	S/ABS	C-5673	
LOGAN		CILINDRO MESTRE DUPL0 20,63mm	2007/...	S/ABS	C-2178	
LOGAN	->	CILINDRO DE RODA 19,00mm	2007/2013	EXPRESSION MOTOR 1.0	C-3542	

Tabela de Conversão	Polegadas	9/16"	5/8"	11/16"	7/10"	3/4"	13/16"	7/8"	15/16"	1"	1 1/16"	1 1/8"	1 1/4"	1 3/8"	1 1/2"	1 5/8"	1 3/4"	1 27/32"	2"
	Milímetros	14,28mm	15,87mm	17,46mm	17,78mm	19,05mm	20,63mm	22,22mm	23,81mm	25,40mm	26,98mm	28,57mm	31,75mm	34,92mm	38,10mm	41,27mm	44,45mm	46,83mm	50,80mm

VEÍCULO		DESCRIÇÃO	ANOS	OBSERVAÇÃO	REF.	IMAGEM
<b>RENAULT</b>						
LOGAN	->	CILINDRO DE RODA 17,46mm	2008/2013	MOTOR 1.6	C-3537	
MEGANE		CIL. ATUADOR CONCÊNTRICO DE EMBREAGEM	1999/2006	CONECTOR CINZA	C-2714	
MEGANE		CILINDRO MESTRE DUPLO 20,63mm	1997/1999	S/ABS	C-2065	
MEGANE		REPARO DO CILINDRO MESTRE DUPLO 20,63mm	1997/1999	C/ CIL. CONTROLIL S/ABS	C-1165	
MEGANE		VEDANTE DO CILINDRO MESTRE	1997/2005		VE-0204	
MEGANE	<-	REPARO DE VEDAÇÃO DA PINÇA 54,00mm	1997/2005		C-1558	
MEGANE	<-	TAPA PÓ DO PINO DE GUIA	1997/2005		TA-0322	
MEGANE	->	CILINDRO DE RODA 17,46mm	1997/2005		C-3473	
MEGANE	->	REPARO DO CILINDRO DE RODA 17,46mm	1997/2005		C-1590	
MEGANE	->	GAXETA DO CILINDRO DE RODA 17,46mm	1997/2005		GA-0309	
MEGANE	->	TAPA-PÓ DO CILINDRO DE RODA	1997/2005		TA-0367	
MASTER		CIL. ATUADOR CONCÊNTRICO DE EMBREAGEM	2002/2004	MOTOR 2.8 DTI	C-2710	
MASTER		CIL. ATUADOR CONCÊNTRICO DE EMBREAGEM	2004/...	MOTOR 2.5 DCI C/ CÂMBIO PK5	C-2710	
MASTER		CILINDRO MESTRE DUPLO 23,81 / 25,40mm	1998/2001	2.8 dTI	C-2192	
MASTER		CILINDRO MESTRE DUPLO 23,81 / 25,40mm	2001/2005	2.5 dCI	C-2192	
SANDERO		SERVO FREIO 230mm	2008/2011	S/ABS	C-5673	
SANDERO		CILINDRO MESTRE DUPLO 20,63mm	2008/...	S/ABS	C-2178	
SANDERO	->	CILINDRO DE RODA 19,00mm	2007/2014	EXPRESSION MOTOR 1.0	C-3542	

BUSCA POR VEÍCULOS

Tabela de Conversão	Polegadas	9/16"	5/8"	11/16"	7/10"	3/4"	13/16"	7/8"	15/16"	1"	1 1/16"	1 1/8"	1 1/4"	1 3/8"	1 1/2"	1 5/8"	1 3/4"	1 27/32"	2"
	Milímetros	14,28mm	15,87mm	17,46mm	17,78mm	19,05mm	20,63mm	22,22mm	23,81mm	25,40mm	26,98mm	28,57mm	31,75mm	34,92mm	38,10mm	41,27mm	44,45mm	46,83mm	50,80mm



VEÍCULO		DESCRIÇÃO	ANOS	OBSERVAÇÃO	REF.	IMAGEM
<b>RENAULT</b>						
SANDERO	->	CILINDRO DE RODA 17,46mm	2008/2014	MOTOR 1.6	C-3537	
SYMBOL		SERVO FREIO 230mm	2009/...	S/ABS	C-5662	
SYMBOL		CILINDRO MESTRE DUPLO 20,63mm	2009/...	S/ABS	C-2096	
SYMBOL		REPARO DO CILINDRO MESTRE DUPLO 20,63mm	2009/...	S/ABS	C-1174	
SYMBOL		VEDANTE DO CILINDRO MESTRE	2009/...		VE-0204	
SYMBOL	<-	REPARO DE VEDAÇÃO DA PINÇA 48,00mm	2009/...		C-1413	
SYMBOL	->	CILINDRO DE RODA 17,46mm	2009/2013		C-3537	
SCENIC		CIL. ATUADOR CONCÊNTRICO DE EMBREAGEM	1999/2006	CONECTOR CINZA	C-2714	
SCENIC		CILINDRO MESTRE DUPLO 23,81mm	1999/2011	S/ABS	C-2128	
SCENIC		REPARO DO CILINDRO MESTRE DUPLO 23,81mm	1999/2011	S/ABS	C-1175	
SCENIC		VEDANTE DO CILINDRO MESTRE	1999/2011		VE-0204	
SCENIC	<-	REPARO DE VEDAÇÃO DA PINÇA 54,00mm	1999/2011		C-1558	
SCENIC	<-	TAPA PÓ DO PINO DE GUIA	1999/2011		TA-0322	
SCENIC	->	CILINDRO DE RODA 20,63mm	1999/2011		C-3478	
SCENIC	->	REPARO DO CILINDRO DE RODA 20,63mm	1999/2011		C-1578	
SCENIC	->	GAXETA DO CILINDRO DE RODA 20,63mm	1999/2011		GA-0206	
SCENIC	->	TAPA-PÓ DO CILINDRO DE RODA	1999/2011		TA-0312	
TRAFIC		CILINDRO MESTRE DUPLO 23,81mm	1992/2003		C-2064	
TRAFIC		REPARO DO CILINDRO MESTRE DUPLO 23,81mm	1992/2003		C-1164	
TRAFIC		VEDANTE DO CILINDRO MESTRE	1992/2003		VE-0204	
TRAFIC	->	CILINDRO DE RODA 23,81mm	1992/2003		C-3463	

Tabela de Conversão	Polegadas	9/16"	5/8"	11/16"	7/10"	3/4"	13/16"	7/8"	15/16"	1"	1 1/16"	1 1/8"	1 1/4"	1 3/8"	1 1/2"	1 5/8"	1 3/4"	1 27/32"	2"
	Milímetros	14,28mm	15,87mm	17,46mm	17,78mm	19,05mm	20,63mm	22,22mm	23,81mm	25,40mm	26,98mm	28,57mm	31,75mm	34,92mm	38,10mm	41,27mm	44,45mm	46,83mm	50,80mm

VEÍCULO		DESCRIÇÃO	ANOS	OBSERVAÇÃO	REF.	IMAGEM
<b>RENAULT</b>						
TRAFIC	->	REPARO DO CILINDRO DE RODA 23,81mm	1992/2003		C-1579	
TRAFIC	->	GAXETA DO CILINDRO DE RODA 23,81mm	1992/2003		GA-0308	
TRAFIC	->	TAPA-PÓ DO CILINDRO DE RODA	1992/2003		TA-0378	
TWINGO		CILINDRO MESTRE DUPLO 20,63mm	1994/2002	S/ABS	C-2135	
TWINGO		VEDANTE DO CILINDRO MESTRE	1994/2002		VE-0204	
<b>SCANIA - CAMINHÕES</b>						
F/K/S-112		CILINDRO MESTRE DE EMBREAGEM 25,40mm	1983/1990		C-2620	
F/K/S-112		REPARO DO CIL. MESTRE DE EMBREAGEM 25,40mm	1983/1990		C-1634	
R/T-112		CILINDRO MESTRE DE EMBREAGEM 25,40mm	1981/1991		C-2620	
R/T-112		REPARO DO CIL. MESTRE DE EMBREAGEM 25,40mm	1981/1991		C-1634	
R/T-113		CILINDRO MESTRE DE EMBREAGEM 26,00mm	1991/1998		C-2623	
R/T-113		REPARO DO CIL. MESTRE DE EMBREAGEM 26,00mm	1991/1998		C-1635	
R/T-142		CILINDRO MESTRE DE EMBREAGEM 25,40mm	1981/1991		C-2620	
R/T-142		REPARO DO CIL. MESTRE DE EMBREAGEM 25,40mm	1981/1991		C-1634	
R/T-143		CILINDRO MESTRE DE EMBREAGEM 26,00mm	1991/1995		C-2623	
R/T-143		REPARO DO CIL. MESTRE DE EMBREAGEM 26,00mm	1991/1995		C-1635	
K113		CILINDRO MESTRE DE EMBREAGEM 25,40mm	TODOS	SÉRIE 3	C-2683	
L113		CILINDRO MESTRE DE EMBREAGEM 25,40mm	TODOS	SÉRIE 3	C-2683	
<b>SEAT</b>						
CORDOBA		SERVO FREIO 230mm	1995/2002		C-5643	

BUSCA POR VEÍCULOS

Tabela de Conversão	Polegadas	9/16"	5/8"	11/16"	7/10"	3/4"	13/16"	7/8"	15/16"	1"	1 1/16"	1 1/8"	1 1/4"	1 3/8"	1 1/2"	1 5/8"	1 3/4"	1 27/32"	2"
	Milímetros	14,28mm	15,87mm	17,46mm	17,78mm	19,05mm	20,63mm	22,22mm	23,81mm	25,40mm	26,98mm	28,57mm	31,75mm	34,92mm	38,10mm	41,27mm	44,45mm	46,83mm	50,80mm

VEÍCULO		DESCRIÇÃO	ANOS	OBSERVAÇÃO	REF.	IMAGEM
<b>SEAT</b>						
CORDOBA		CILINDRO MESTRE DUPL0 20,63mm	1995/1999	S/ABS	C-2067	
CORDOBA		CILINDRO MESTRE DUPL0 22,22mm	2000/2002	S/ABS	C-2074	
CORDOBA		REPARO DO CILINDRO MESTRE DUPL0 20,63mm	1995/1999	S/ABS C/CIL. ATE	C-1156	
CORDOBA		REPARO DO CILINDRO MESTRE DUPL0 20,63mm	1995/1999	S/ABS C/CIL. BENDIX	C-1168	
CORDOBA		REPARO DO CILINDRO MESTRE DUPL0 22,22mm	2000/2002	S/ABS C/CIL. ATE	C-1158	
CORDOBA		REPARO DO CILINDRO MESTRE DUPL0 22,22mm	2000/2002	S/ABS C/CIL. BENDIX	C-1163	
CORDOBA		VEDANTE DO CILINDRO MESTRE	1995/2002		VE-0204	
CORDOBA	<-	REPARO DE VEDAÇÃO DA PINÇA 48,00mm	1995/1999		C-1443	
CORDOBA	<-	REPARO DE VEDAÇÃO DA PINÇA 54,00mm	2000/2002		C-1558	
CORDOBA	<-	TAPA PÓ DO PINO DE GUIA	2000/2002		TA-0322	
CORDOBA	->	CILINDRO DE RODA 19,05mm	1995/2002		C-3440	
CORDOBA	->	REPARO DO CILINDRO DE RODA 19,05mm	1995/2002		C-1447	
CORDOBA	->	GAXETA DO CILINDRO DE RODA 19,05mm	1995/2002		GA-0307	
CORDOBA	->	TAPA PÓ DO CILINDRO DE RODA	1995/2002		TA-0343	
CORDOBA VARIO		SERVO FREIO 230mm	2000/2002		C-5643	
CORDOBA VARIO		CILINDRO MESTRE DUPL0 22,22mm	2000/2002	S/ABS	C-2074	
CORDOBA VARIO		REPARO DO CILINDRO MESTRE DUPL0 22,22mm	2000/2002	S/ABS C/CIL. ATE	C-1158	
CORDOBA VARIO		REPARO DO CILINDRO MESTRE DUPL0 22,22mm	2000/2002	S/ABS C/CIL. BENDIX	C-1163	
CORDOBA VARIO		VEDANTE DO CILINDRO MESTRE	2000/2002		VE-0204	
CORDOBA VARIO	<-	REPARO DE VEDAÇÃO DA PINÇA 54,00mm	2000/2002		C-1558	
CORDOBA VARIO	<-	TAPA PÓ DO PINO DE GUIA	2000/2002		TA-0322	
CORDOBA VARIO	->	CILINDRO DE RODA 19,05mm	2000/2002		C-3440	
CORDOBA VARIO	->	REPARO DO CILINDRO DE RODA 19,05mm	2000/2002		C-1447	
CORDOBA VARIO	->	GAXETA DO CILINDRO DE RODA 19,05mm	2000/2002		GA-0307	
CORDOBA VARIO	->	TAPA PÓ DO CILINDRO DE RODA	2000/2002		TA-0343	
IBIZA		SERVO FREIO 230mm	1995/2002		C-5643	

Tabela de Conversão	Polegadas	9/16"	5/8"	11/16"	7/10"	3/4"	13/16"	7/8"	15/16"	1"	1 1/16"	1 1/8"	1 1/4"	1 3/8"	1 1/2"	1 5/8"	1 3/4"	1 27/32"	2"
	Milímetros	14,28mm	15,87mm	17,46mm	17,78mm	19,05mm	20,63mm	22,22mm	23,81mm	25,40mm	26,98mm	28,57mm	31,75mm	34,92mm	38,10mm	41,27mm	44,45mm	46,83mm	50,80mm

VEÍCULO		DESCRIÇÃO	ANOS	OBSERVAÇÃO	REF.	IMAGEM
<b>SEAT</b>						
IBIZA		CILINDRO MESTRE DUPL0 20,63mm	1995/1999	S/ABS	C-2067	
IBIZA		CILINDRO MESTRE DUPL0 22,22mm	2000/2002	S/ABS	C-2074	
IBIZA		REPARO DO CILINDRO MESTRE DUPL0 20,63mm	1995/1999	S/ABS C/CIL. ATE	C-1156	
IBIZA		REPARO DO CILINDRO MESTRE DUPL0 20,63mm	1995/1999	S/ABS C/CIL. BENDIX	C-1168	
IBIZA		REPARO DO CILINDRO MESTRE DUPL0 22,22mm	2000/2002	S/ABS C/CIL. ATE	C-1158	
IBIZA		REPARO DO CILINDRO MESTRE DUPL0 22,22mm	2000/2002	S/ABS C/CIL. BENDIX	C-1163	
IBIZA		VEDANTE DO CILINDRO MESTRE	1995/2002		VE-0204	
IBIZA	<-	REPARO DE VEDAÇÃO DA PINÇA 48,00mm	1995/1999		C-1443	
IBIZA	<-	REPARO DE VEDAÇÃO DA PINÇA 48,00mm	2000/2002	MOTOR 1.0	C-1443	
IBIZA	<-	REPARO DE VEDAÇÃO DA PINÇA 54,00mm	2000/2002	MOTOR 1.6	C-1558	
IBIZA	<-	TAPA PÓ DO PINO DE GUIA	2000/2002		TA-0322	
IBIZA	->	CILINDRO DE RODA 19,05mm	1995/2002		C-3440	
IBIZA	->	REPARO DO CILINDRO DE RODA 19,05mm	1995/2002		C-1447	
IBIZA	->	GAXETA DO CILINDRO DE RODA 19,05mm	1995/2002		GA-0307	
IBIZA	->	TAPA PÓ DO CILINDRO DE RODA	1995/2002		TA-0343	
INCA		CILINDRO AUXILIAR DE EMBREAGEM 19,05mm	2001/2002		C-2656	
INCA		SERVO FREIO 230mm	1999/2002		C-5643	
INCA		CILINDRO MESTRE DUPL0 22,22mm	1999/2002		C-2074	
INCA		REPARO DO CILINDRO MESTRE DUPL0 22,22mm	1999/2002	C/CIL. ATE	C-1158	
INCA		REPARO DO CILINDRO MESTRE DUPL0 22,22mm	1999/2002	C/CIL. BENDIX	C-1163	
INCA		VEDANTE DO CILINDRO MESTRE	1999/2002		VE-0204	
INCA	<-	REPARO DE VEDAÇÃO DA PINÇA 54,00mm	1999/2002		C-1558	
INCA	<-	TAPA PÓ DO PINO DE GUIA	1999/2002		TA-0322	
INCA	->	CILINDRO DE RODA 20,63mm	1999/2002		C-3480	
INCA	->	REPARO DO CILINDRO DE RODA 20,63mm	1999/2002		C-1593	
INCA	->	GAXETA DO CILINDRO DE RODA 20,63mm	1999/2002		GA-0217	
INCA	->	TAPA PÓ DO CILINDRO DE RODA	1999/2002		TA-0343	

BUSCA POR VEÍCULOS

Tabela de Conversão	Polegadas	9/16"	5/8"	11/16"	7/10"	3/4"	13/16"	7/8"	15/16"	1"	1 1/16"	1 1/8"	1 1/4"	1 3/8"	1 1/2"	1 5/8"	1 3/4"	1 27/32"	2"
	Milímetros	14,28mm	15,87mm	17,46mm	17,78mm	19,05mm	20,63mm	22,22mm	23,81mm	25,40mm	26,98mm	28,57mm	31,75mm	34,92mm	38,10mm	41,27mm	44,45mm	46,83mm	50,80mm

VEÍCULO		DESCRIÇÃO	ANOS	OBSERVAÇÃO	REF.	IMAGEM
<b>SUZUKI</b>						
GRAND VITARA	->	CILINDRO DE RODA ESQUERDA 22,22mm	1998/2003		C-3532	
GRAND VITARA	->	CILINDRO DE RODA DIREITA 22,22mm	1998/2003		C-3533	
SWIFT+	->	CILINDRO DE RODA 20,63mm	2007 / 2011	MEXICO	C-3541	
<b>TOYOTA</b>						
BANDEIRANTE		CILINDRO MESTRE DE EMBREAGEM 25,40mm	1966/1978		C-2618	
BANDEIRANTE		CILINDRO MESTRE DE EMBREAGEM 22,22mm	1979/1980		C-2619	
BANDEIRANTE		CILINDRO MESTRE DE EMBREAGEM 22,22mm	1980/1986		C-2609	
BANDEIRANTE		CILINDRO MESTRE DE EMBREAGEM 22,22mm	1987/1994		C-2606	
BANDEIRANTE		CILINDRO AUXILIAR DE EMBREAGEM 22,22mm	1966/1994		C-2617	
BANDEIRANTE		REPARO DO CIL. MESTRE DE EMBREAGEM 25,40mm	1966/1978		C-1603	
BANDEIRANTE		REPARO DO CIL. MESTRE DE EMBREAGEM 22,22mm	1979/1986		C-1614	
BANDEIRANTE		REPARO DO CIL. MESTRE DE EMBREAGEM 22,22mm	1987/1994		C-1623	
BANDEIRANTE		REPARO DO CIL. AUXILIAR DE EMBREAGEM 22,22mm	1966/1994		C-1604	
BANDEIRANTE		VEDANTE DO CILINDRO MESTRE	1987/1994		VE-0204	
BANDEIRANTE		SERVO FREIO 200mm	1983/1986		C-5633	
BANDEIRANTE		SERVO FREIO 230mm	1987/1993		C-5628	
BANDEIRANTE		VÁLVULA DE RETENÇÃO DE VÁCUO BRANCA	1982/1986	P/ SERVO VARGA FD180/SM180	C-1750	

Tabela de Conversão	Polegadas	9/16"	5/8"	11/16"	7/10"	3/4"	13/16"	7/8"	15/16"	1"	1 1/16"	1 1/8"	1 1/4"	1 3/8"	1 1/2"	1 5/8"	1 3/4"	1 27/32"	2"
	Milímetros	14,28mm	15,87mm	17,46mm	17,78mm	19,05mm	20,63mm	22,22mm	23,81mm	25,40mm	26,98mm	28,57mm	31,75mm	34,92mm	38,10mm	41,27mm	44,45mm	46,83mm	50,80mm

VEÍCULO		DESCRIÇÃO	ANOS	OBSERVAÇÃO	REF.	IMAGEM
<b>TOYOTA</b>						
BANDEIRANTE		VÁLVULA DE RETENÇÃO DE VÁCUO	1983/2001		C-1753	
BANDEIRANTE		CILINDRO MESTRE DUPLO 23,81mm	1982/1996	C/ <-	C-2068	
BANDEIRANTE		CILINDRO MESTRE DUPLO 23,81mm	1995/2001	C/ FREIO DIANTEIRO A DISCO	C-2013	
BANDEIRANTE		REPARO DO CILINDRO MESTRE SIMPLES 22,22mm	1966/1981		C-1045	
BANDEIRANTE		REPARO DO CILINDRO MESTRE DUPLO 23,81mm	1982/1996	C/ <-	C-1020	
BANDEIRANTE		REPARO DO CILINDRO MESTRE DUPLO 23,81mm	1995/2001	C/ FREIO DIANTEIRO A DISCO	C-1173	
BANDEIRANTE		RESERVATÓRIO C/ TAMPA	1982/2001		C-0108	
BANDEIRANTE		VEDANTE DO CILINDRO MESTRE	1982/2001		VE-0201	
BANDEIRANTE	<-	CILINDRO DE RODA ESQUERDA ANTERIOR 25,40mm	1980/1996		C-3386	
BANDEIRANTE	<-	CILINDRO DE RODA ESQUERDA POSTERIOR 25,40mm	1980/1996		C-3387	
BANDEIRANTE	<-	CILINDRO DE RODA DIREITA ANTERIOR 25,40mm	1980/1996		C-3388	
BANDEIRANTE	<-	CILINDRO DE RODA DIREITA POSTERIOR 25,40mm	1980/1996		C-3389	
BANDEIRANTE	<-	REPARO DO CILINDRO DE RODA 25,40mm	1966/1979		C-1486	
BANDEIRANTE	<-	REPARO DO CILINDRO DE RODA 25,40mm	1980/1996		C-1417	
BANDEIRANTE	<-	COPO DO CILINDRO DE RODA 25,40mm	1966/1996		CO-1307	
BANDEIRANTE	<-	TAPA-PÓ DO CILINDRO DE RODA	1966/1979		TA-0334	
BANDEIRANTE	<-	TAPA-PÓ DO CILINDRO DE RODA	1966/1979		TA-0335	
BANDEIRANTE	<-	TAPA-PÓ DO CILINDRO DE RODA	1980/1996		TA-0304	
BANDEIRANTE	<-	TAPA-PÓ DO CILINDRO DE RODA	1980/1996		TA-0305	
BANDEIRANTE	<-	REPARO DE VEDAÇÃO DA PINÇA 66,00mm	1995/2001		C-1547	
BANDEIRANTE	->	CILINDRO DE RODA ESQUERDA ANTERIOR 22,22mm	1980/1996	C/ <-	C-3382	
BANDEIRANTE	->	CILINDRO DE RODA ESQUERDA POSTERIOR 22,22mm	1980/1996	C/ <-	C-3383	

Tabela de Conversão	Polegadas	9/16"	5/8"	11/16"	7/10"	3/4"	13/16"	7/8"	15/16"	1"	1 1/16"	1 1/8"	1 1/4"	1 3/8"	1 1/2"	1 5/8"	1 3/4"	1 27/32"	2"
	Milímetros	14,28mm	15,87mm	17,46mm	17,78mm	19,05mm	20,63mm	22,22mm	23,81mm	25,40mm	26,98mm	28,57mm	31,75mm	34,92mm	38,10mm	41,27mm	44,45mm	46,83mm	50,80mm

VEÍCULO		DESCRIÇÃO	ANOS	OBSERVAÇÃO	REF.	IMAGEM
<b>TOYOTA</b>						
BANDEIRANTE	->	CILINDRO DE RODA DIREITA ANTERIOR 22,22mm	1980/1996	C/ <-	C-3384	
BANDEIRANTE	->	CILINDRO DE RODA DIREITA POSTERIOR 22,22mm	1980/1996	C/ <-	C-3385	
BANDEIRANTE	->	REPARO DO CILINDRO DE RODA 25,40mm	1966/1979		C-1486	
BANDEIRANTE	->	REPARO DO CILINDRO DE RODA 22,22mm	1980/1996	C/ <-	C-1418	
BANDEIRANTE	->	REPARO DO CILINDRO DE RODA 23,81mm	1995/2001	C/ FREIO DIANTEIRO A DISCO	C-1569	
BANDEIRANTE	->	COPO DO CILINDRO DE RODA 25,40mm	1966/1979		CO-1307	
BANDEIRANTE	->	COPO DO CILINDRO DE RODA 22,22mm	1980/1996	C/ <-	CO-1315	
BANDEIRANTE	->	GAXETA DO CILINDRO DE RODA 23,81mm	1995/2001	C/ FREIO DIANTEIRO A DISCO	GA-0308	
BANDEIRANTE	->	TAPA-PÓ DO CILINDRO DE RODA	1966/1979		TA-0334	
BANDEIRANTE	->	TAPA-PÓ DO CILINDRO DE RODA	1966/1979		TA-0335	
BANDEIRANTE	->	TAPA-PÓ DO CILINDRO DE RODA	1980/2001		TA-0304	
BANDEIRANTE	->	TAPA-PÓ DO CILINDRO DE RODA	1980/2001		TA-0305	
COROLLA		CILINDRO MESTRE DE EMBREAGEM 15,87mm	1993/2002		C-2671	
COROLLA		CILINDRO AUXILIAR DE EMBREAGEM 20,63mm	1993/2002		C-2678	
COROLLA		CILINDRO MESTRE DUPLA 20,63mm	2003/2008		C-2161	
COROLLA	->	CILINDRO DE RODA ESQUERDA 17,46mm	1992/1998		C-3484	
COROLLA	->	CILINDRO DE RODA DIREITA 17,46mm	1992/1998		C-3485	
COROLLA	->	CILINDRO DE RODA ESQUERDA 19,05mm	1998/2002		C-3502	
COROLLA	->	CILINDRO DE RODA DIREITA 19,05mm	1998/2002		C-3503	
COROLLA	->	REPARO DO CILINDRO DE RODA 17,46mm	1992/1998		C-1596	
COROLLA	->	REPARO DO CILINDRO DE RODA 19,05mm	1998/2002		C-1400	

Tabela de Conversão	Polegadas	9/16"	5/8"	11/16"	7/10"	3/4"	13/16"	7/8"	15/16"	1"	1 1/16"	1 1/8"	1 1/4"	1 3/8"	1 1/2"	1 5/8"	1 3/4"	1 27/32"	2"
	Milímetros	14,28mm	15,87mm	17,46mm	17,78mm	19,05mm	20,63mm	22,22mm	23,81mm	25,40mm	26,98mm	28,57mm	31,75mm	34,92mm	38,10mm	41,27mm	44,45mm	46,83mm	50,80mm

VEÍCULO		DESCRIÇÃO	ANOS	OBSERVAÇÃO	REF.	IMAGEM
<b>TOYOTA</b>						
COROLLA	->	GAXETA DO CILINDRO DE RODA 17,46mm	1992/1998		GA-0309	
COROLLA	->	GAXETA DO CILINDRO DE RODA 19,05mm	1998/2002		GA-0307	
COROLLA	->	TAPA-PÓ DO CILINDRO DE RODA	1992/2002		TA-0392	
COROLLA FIELDER		CILINDRO MESTRE DUPLO 20,63mm	2004/2008		C-2161	
CORONA	->	REPARO DO CILINDRO DE RODA 20,63mm	1996/2000		C-1509	
CORONA	->	GAXETA DO CILINDRO DE RODA 20,63mm	1996/2000		GA-0206	
CORONA	->	TAPA-PÓ DO CILINDRO DE RODA	1996/2000		TA-0312	
ETIOS	->	CILINDRO DE RODA 19,00mm	2013/...		C-3544	
HILUX PICK-UP		CILINDRO MESTRE DE EMBREAGEM 15,87mm	2006/		C-2673	
HILUX PICK-UP		CILINDRO AUXILIAR DE EMBREAGEM 20,63mm	2001/2004		C-2676	
HILUX PICK-UP	<-	REPARO DE VEDAÇÃO DA PINÇA 42,70mm	1999/2005	SIST. VARGA	C-1449	
HILUX PICK-UP	->	CILINDRO DE RODA 22,22mm	1992/2005	4X4	C-3491	
HILUX PICK-UP	->	CILINDRO DE RODA 22,22mm	1992/2005	4X2	C-3534	
HILUX PICK-UP	->	CILINDRO DE RODA 22,22mm	2006/...		C-3531	
HILUX PICK-UP	->	REPARO DO CILINDRO DE RODA 22,22mm	1992/2005	4X4	C-1570	
HILUX PICK-UP	->	REPARO DO CILINDRO DE RODA 22,22mm	2006/...		C-1582	
HILUX PICK-UP	->	GAXETA DO CILINDRO DE RODA 22,22mm	1992/2005	4X4	GA-0314	
HILUX PICK-UP	->	GAXETA DO CILINDRO DE RODA 22,22mm	2006/...		GA-0207	
HILUX PICK-UP	->	TAPA-PÓ DO CILINDRO DE RODA	1992/2005	4X4	TA-0391	
HILUX PICK-UP	->	TAPA-PÓ DO CILINDRO DE RODA	2006/...		TA-0312	
HILUX SW4		CILINDRO MESTRE DE EMBREAGEM 15,87mm	1992/2005		C-2672	









BUSCA POR VEÍCULOS

Tabela de Conversão	Polegadas	9/16"	5/8"	11/16"	7/10"	3/4"	13/16"	7/8"	15/16"	1"	1 1/16"	1 1/8"	1 1/4"	1 3/8"	1 1/2"	1 5/8"	1 3/4"	1 27/32"	2"
	Milímetros	14,28mm	15,87mm	17,46mm	17,78mm	19,05mm	20,63mm	22,22mm	23,81mm	25,40mm	26,98mm	28,57mm	31,75mm	34,92mm	38,10mm	41,27mm	44,45mm	46,83mm	50,80mm



VEÍCULO		DESCRIÇÃO	ANOS	OBSERVAÇÃO	REF.	IMAGEM
<b>TOYOTA</b>						
HILUX SW4		CILINDRO MESTRE DE EMBREAGEM 15,87mm	2006/		C-2673	
HILUX SW4		CILINDRO AUXILIAR DE EMBREAGEM 20,63mm	1992/2001		C-2676	
HILUX SW4	->	CILINDRO DE RODA 22,22mm	1992/1995		C-3491	
HILUX SW4	->	CILINDRO DE RODA 23,81mm	1996/2000	C/ ARO 15"	C-3483	
HILUX SW4	->	CILINDRO DE RODA 25,40mm	2000/2005	C/ ARO 16"	C-3517	
HILUX SW4	->	CILINDRO DE RODA 22,22mm	2006/...		C-3531	
HILUX SW4	->	REPARO DO CILINDRO DE RODA 22,22mm	1992/1995		C-1570	
HILUX SW4	->	REPARO DO CILINDRO DE RODA 23,81mm	1996/2000	C/ ARO 15"	C-1595	
HILUX SW4	->	REPARO DO CILINDRO DE RODA 25,40mm	2000/2005	C/ ARO 16"	C-1455	
HILUX SW4	->	REPARO DO CILINDRO DE RODA 22,22mm	2006/...		C-1582	
HILUX SW4	->	GAXETA DO CILINDRO DE RODA 22,22mm	1992/1995		GA-0314	
HILUX SW4	->	GAXETA DO CILINDRO DE RODA 23,81mm	1996/2000	C/ ARO 15"	GA-0308	
HILUX SW4	->	GAXETA DO CILINDRO DE RODA 25,40mm	2000/2005	C/ ARO 16"	GA-0303	
HILUX SW4	->	GAXETA DO CILINDRO DE RODA 22,22mm	2006/...		GA-0207	
HILUX SW4	->	TAPA-PÓ DO CILINDRO DE RODA	1992/2005		TA-0391	
HILUX SW4	->	TAPA-PÓ DO CILINDRO DE RODA	2006/...		TA-0312	
PASEO	->	CILINDRO DE RODA ESQUERDA 17,46mm	1992/1995		C-3484	
PASEO	->	CILINDRO DE RODA DIREITA 17,46mm	1992/1995		C-3485	
PASEO	->	REPARO DO CILINDRO DE RODA 17,46mm	1992/1995		C-1596	
PASEO	->	GAXETA DO CILINDRO DE RODA 17,46mm	1992/1995		GA-0309	
PASEO	->	TAPA-PÓ DO CILINDRO DE RODA	1992/1995		TA-0392	
<b>TROLLER</b>						
T4		CILINDRO MESTRE DE EMBREAGEM 22,22mm	2002/...		C-2606	

Tabela de Conversão	Polegadas	9/16"	5/8"	11/16"	7/10"	3/4"	13/16"	7/8"	15/16"	1"	1 1/16"	1 1/8"	1 1/4"	1 3/8"	1 1/2"	1 5/8"	1 3/4"	1 7/32"	2"
	Milímetros	14,28mm	15,87mm	17,46mm	17,78mm	19,05mm	20,63mm	22,22mm	23,81mm	25,40mm	26,98mm	28,57mm	31,75mm	34,92mm	38,10mm	41,27mm	44,45mm	46,83mm	50,80mm

VEÍCULO		DESCRIÇÃO	ANOS	OBSERVAÇÃO	REF.	IMAGEM
<b>TROLLER</b>						
T4		CILINDRO AUXILIAR DE EMBREAGEM 22,22mm	2002/...		C-2617	
T4		REPARO DO CIL. MESTRE DE EMBREAGEM 22,22mm	2002/...		C-1623	
T4		REPARO DO CIL. AUXILIAR DE EMBREAGEM 22,22mm	2002/...		C-1604	
T4		VEDANTE DO CILINDRO MESTRE	2002/...		VE-0204	
T4		SERVO FREIO 230mm	1997/2001		C-5608	
T4		VÁLVULA DE RETENÇÃO DE VÁCUO	1997/2001		C-1753	
T4		VÁLVULA DE RETENÇÃO DE VÁCUO	2002/...		C-1755	
T4		CILINDRO MESTRE DUPLO 22,22mm	1997/2001		C-2060	
T4		CILINDRO MESTRE DUPLO 23,81mm	2001/2002		C-2128	
T4		CILINDRO MESTRE DUPLO 25,40mm	2002/...		C-2073	
T4		REPARO DO CILINDRO MESTRE DUPLO 22,22mm	1997/2001		C-1137	
T4		REPARO DO CILINDRO MESTRE DUPLO 22,22mm	1997/2001	P/ CILINDRO BOSCH	C-1144	
T4		REPARO DO CILINDRO MESTRE DUPLO 23,81mm	2001/2002		C-1175	
T4		REPARO DO CILINDRO MESTRE DUPLO 25,40mm	2002/...		C-1133	
T4		RESERVATÓRIO C/ TAMP. E AVISO DE NÍVEL	1997/2001		C-0107	
T4		VEDANTE DO CILINDRO MESTRE	1997/2001		VE-0201	
T4		VEDANTE DO CILINDRO MESTRE	2001/...		VE-0204	
T4	<	REPARO DE VEDAÇÃO DA PINÇA 57,00mm	2002/...		C-1567	
<b>VOLKSWAGEN</b>						
APOLLO		SERVO FREIO 200mm	1990/1992		C-5603	
APOLLO		CILINDRO MESTRE DUPLO 22,00mm	1990/1992		C-2008	
APOLLO		REPARO DO CILINDRO MESTRE DUPLO 22,00mm	1990/1992		C-1012	
APOLLO		VEDANTE DO CILINDRO MESTRE	1990/1992		VE-0204	
APOLLO	<	REPARO DE VEDAÇÃO DA PINÇA 54,00mm	1990/1992		C-1419	
APOLLO	>	CILINDRO DE RODA 17,78mm	1990/1992		C-3439	
APOLLO	>	REPARO DO CILINDRO DE RODA 17,78mm	1990/1992	P/ CIL. VARGA RCCR 0094.5	C-1420	
APOLLO	>	REPARO DO CILINDRO DE RODA 17,78mm	1990/1992		C-1566	
APOLLO	>	GAXETA DO CILINDRO DE RODA 17,78mm	1990/1992		GA-0301	
APOLLO	>	TAPA-PÓ DO CILINDRO DE RODA	1990/1992		TA-0312	
APOLLO	>	TAPA-PÓ DO CILINDRO DE RODA	1990/1992	P/ CIL. VARGA RCCR 0094.5	TA-0317	

BUSCA POR VEÍCULOS

218

Tabela de Conversão	Polegadas	9/16"	5/8"	11/16"	7/10"	3/4"	13/16"	7/8"	15/16"	1"	1 1/16"	1 1/8"	1 1/4"	1 3/8"	1 1/2"	1 5/8"	1 3/4"	1 27/32"	2"
	Milímetros	14,28mm	15,87mm	17,46mm	17,78mm	19,05mm	20,63mm	22,22mm	23,81mm	25,40mm	26,98mm	28,57mm	31,75mm	34,92mm	38,10mm	41,27mm	44,45mm	46,83mm	50,80mm

VEÍCULO		DESCRIÇÃO	ANOS	OBSERVAÇÃO	REF.	IMAGEM
<b>VOLKSWAGEN</b>						
AMAROK		CILINDRO MESTRE DE EMBREAGEM 19,05mm	2010/...	2.0 TDI (140 cv/180 cv)	C-2690	
AMAROK		CIL. ATUADOR CONCÊNTRICO DE EMBREAGEM	2010/...	2.0 TDI (140 cv/180 cv)	C-2715	
AMAROK	->	CILINDRO DE RODA 27,00mm	2011/...		C-3543	
BORA		CILINDRO MESTRE DE EMBREAGEM 15,87mm	2001/2011		C-2650	
BORA		CILINDRO AUXILIAR DE EMBREAGEM 19,05mm	2001/2011		C-2656	
BORA		CILINDRO MESTRE DUPLA 23,81mm	2001/2007		C-2095	
BORA		REPARO DO CILINDRO MESTRE DUPLA 23,81mm	2001/2007		C-1172	
BORA		VEDANTE DO CILINDRO MESTRE	2001/2011		VE-0204	
BORA	<-	REPARO DE VEDAÇÃO DA PINÇA 54,00mm	2001/2011		C-1587	
BORA	->	TAPA PÓ DO PINO DE GUIA	2001/2011		TA-0322	
BRASILIA		CILINDRO MESTRE SIMPLES 19,05mm	1973/1976		C-2005	
BRASILIA		CILINDRO MESTRE DUPLA 19,05mm	1977/1982		C-2007	
BRASILIA		REPARO DO CILINDRO MESTRE SIMPLES 19,05mm	1973/1976		C-1061	
BRASILIA		REPARO DO CILINDRO MESTRE DUPLA 19,05mm	1977/1982		C-1060	
BRASILIA		VEDANTE DO CILINDRO MESTRE	1973/1982		VE-0201	
BRASILIA	<-	REPARO DE VEDAÇÃO DA PINÇA 40,00mm	1973/1982		C-1498	
BRASILIA	->	CILINDRO DE RODA 22,22mm	1973/1982		C-3357	
BRASILIA	->	REPARO DO CILINDRO DE RODA 19,05mm	1973/1976	P/ CILINDRO 3/4"	C-1473	
BRASILIA	->	REPARO DO CILINDRO DE RODA 22,22mm	1973/1982		C-1496	
BRASILIA	->	COPO DO CILINDRO DE RODA 19,05mm	1973/1976	P/ CILINDRO 3/4"	CO-1312	
BRASILIA	->	COPO DO CILINDRO DE RODA 22,22mm	1973/1982		CO-1315	
BRASILIA	->	TAPA PÓ DO CILINDRO DE RODA	1973/1976	P/ CILINDRO 3/4"	TA-0329	
BRASILIA	->	TAPA PÓ DO CILINDRO DE RODA	1973/1982		TA-0336	
CARAVELLE		CILINDRO AUXILIAR DE EMBREAGEM 19,05mm	1998/1999		C-2656	
CARAVELLE	<-	REPARO DE VEDAÇÃO DA PINÇA 57,00mm	1998/1999		C-1567	

Tabela de Conversão	Polegadas	9/16"	5/8"	11/16"	7/10"	3/4"	13/16"	7/8"	15/16"	1"	1 1/16"	1 1/8"	1 1/4"	1 3/8"	1 1/2"	1 5/8"	1 3/4"	1 27/32"	2"
	Milímetros	14,28mm	15,87mm	17,46mm	17,78mm	19,05mm	20,63mm	22,22mm	23,81mm	25,40mm	26,98mm	28,57mm	31,75mm	34,92mm	38,10mm	41,27mm	44,45mm	46,83mm	50,80mm

VEÍCULO		DESCRIÇÃO	ANOS	OBSERVAÇÃO	REF.	IMAGEM
<b>VOLKSWAGEN</b>						
CARAVELLE	->	REPARO DE VEDAÇÃO DA PINÇA 38,00mm	1998/1999		C-1551	
CROSSFOX		CILINDRO MESTRE DE EMBREAGEM 15,87mm	2005/...		C-2657	
CROSSFOX		CILINDRO AUXILIAR DE EMBREAGEM 19,05mm	2005/...		C-2651	
CROSSFOX		CILINDRO MESTRE DUPLA 20,63mm	2005/...	S/ABS	C-2160	
CROSSFOX	<-	REPARO DE VEDAÇÃO DA PINÇA 54,00mm	2005/...		C-1587	
CROSSFOX	->	CILINDRO DE RODA 17,46mm	2005/...		C-3356	
CROSSFOX	->	REPARO DO CILINDRO DE RODA 17,46mm	2005/...		C-1446	
CROSSFOX	->	GAXETA DO CILINDRO DE RODA 17,46mm	2005/...		GA-0309	
CROSSFOX	->	TAPA-PÓ DO CILINDRO DE RODA	2005/...		TA-0338	
CROSSFOX		MANGUEIRA DO FILTRO DE AR	2004/...	MOTOR 1.6	C-9034	
CROSSFOX		DUTO DE AR LIMPO	2004/...	MOTOR 1.6	C-9032	
EOS	<-	REPARO DE VEDAÇÃO DA PINÇA 54,00mm	2008/2012		C-1587	
EOS	->	REPARO DE VEDAÇÃO DA PINÇA 38,00mm	2008/2012		C-1551	
EUROVAN		CILINDRO AUXILIAR DE EMBREAGEM 19,05mm	1998/1999		C-2656	
EUROVAN	<-	REPARO DE VEDAÇÃO DA PINÇA 57,00mm	1998/1999		C-1567	
EUROVAN	->	REPARO DE VEDAÇÃO DA PINÇA 38,00mm	1998/1999		C-1551	
FOX		CILINDRO MESTRE DE EMBREAGEM 15,87mm	2004/...		C-2657	
FOX		CILINDRO AUXILIAR DE EMBREAGEM 19,05mm	2004/...		C-2651	
FOX		CILINDRO MESTRE DUPLA 20,63mm	2004/...	S/ABS C/DISCO 256x22mm	C-2160	
FOX	<-	REPARO DE VEDAÇÃO DA PINÇA 54,00mm	2004/...	MOTOR 1.6	C-1587	
FOX	<-	REPARO DE VEDAÇÃO DA PINÇA 54,00mm	2004/...	MOTOR 1.0 C/ DISCO 256x22mm	C-1587	

BUSCA POR VEÍCULOS

Tabela de Conversão	Polegadas	9/16"	5/8"	11/16"	7/10"	3/4"	13/16"	7/8"	15/16"	1"	1 1/16"	1 1/8"	1 1/4"	1 3/8"	1 1/2"	1 5/8"	1 3/4"	1 27/32"	2"
	Milímetros	14,28mm	15,87mm	17,46mm	17,78mm	19,05mm	20,63mm	22,22mm	23,81mm	25,40mm	26,98mm	28,57mm	31,75mm	34,92mm	38,10mm	41,27mm	44,45mm	46,83mm	50,80mm

VEÍCULO		DESCRIÇÃO	ANOS	OBSERVAÇÃO	REF.	IMAGEM
<b>VOLKSWAGEN</b>						
FOX	->	CILINDRO DE RODA 17,46mm	2004/...		C-3356	
FOX	->	REPARO DO CILINDRO DE RODA 17,46mm	2004/...		C-1446	
FOX	->	GAXETA DO CILINDRO DE RODA 17,46mm	2004/...		GA-0309	
FOX	->	TAPA-PÓ DO CILINDRO DE RODA	2004/...		TA-0338	
FOX		MANGUEIRA DO FILTRO DE AR	2004/...	MOTOR 1.6	C-9034	
FOX		DUTO DE AR LIMPO	2004/...	MOTOR 1.6	C-9032	
FOX		JOGO ANÉIS VEDAÇÃO COLETOR DE ADMISSÃO	2004/...	MOTOR 1.0 FLEX 8V	C-9506	
FUSCA		CILINDRO MESTRE SIMPLES 19,05mm	1957/1966		C-2059	
FUSCA		CILINDRO MESTRE SIMPLES 17,46mm	1967/1976	C/ <-	C-2003	
FUSCA		CILINDRO MESTRE SIMPLES 19,05mm	1970/1976	C/ FREIO DIANTEIRO A DISCO	C-2005	
FUSCA		CILINDRO MESTRE DUPLO 19,05mm	1977/1996		C-2007	
FUSCA		REPARO DO CILINDRO MESTRE SIMPLES 19,05mm	1957/1966		C-1035	
FUSCA		REPARO DO CILINDRO MESTRE SIMPLES 17,46mm	1967/1976	C/ <-	C-1048	
FUSCA		REPARO DO CILINDRO MESTRE SIMPLES 19,05mm	1970/1976	C/ FREIO DIANTEIRO A DISCO	C-1061	
FUSCA		REPARO DO CILINDRO MESTRE DUPLO 19,05mm	1977/1996		C-1060	
FUSCA		VEDANTE DO CILINDRO MESTRE	1967/1996		VE-0201	
FUSCA	<-	CILINDRO DE RODA 22,22mm	1957/1984		C-3351	
FUSCA	<-	REPARO DO CILINDRO DE RODA 22,22mm	1957/1976	P/ CILINDRO VARGA RCCR 2157.8	C-1472	
FUSCA	<-	REPARO DO CILINDRO DE RODA 22,22mm	1957/1984		C-1496	
FUSCA	<-	COPO DO CILINDRO DE RODA 22,22mm	1957/1984		CO-1315	
FUSCA	<-	TAPA PÓ DO CILINDRO DE RODA	1957/1976	P/ CILINDRO VARGA RCCR 2157.8	TA-0330	
FUSCA	<-	TAPA PÓ DO CILINDRO DE RODA	1957/1984		TA-0336	
FUSCA	<-	REPARO DE VEDAÇÃO DA PINÇA 40,50mm	1970/1996	SIST. VARGA	C-1404	
FUSCA	<-	REPARO DE VEDAÇÃO DA PINÇA 40,00mm	1970/1996	SIST. ATE	C-1498	
FUSCA	->	CILINDRO DE RODA 19,05mm	1957/1976	C/ EIXO 5 FUROS	C-3407	

Tabela de Conversão	Polegadas	9/16"	5/8"	11/16"	7/10"	3/4"	13/16"	7/8"	15/16"	1"	1 1/16"	1 1/8"	1 1/4"	1 3/8"	1 1/2"	1 5/8"	1 3/4"	1 27/32"	2"
	Milímetros	14,28mm	15,87mm	17,46mm	17,78mm	19,05mm	20,63mm	22,22mm	23,81mm	25,40mm	26,98mm	28,57mm	31,75mm	34,92mm	38,10mm	41,27mm	44,45mm	46,83mm	50,80mm

VEÍCULO		DESCRIÇÃO	ANOS	OBSERVAÇÃO	REF.	IMAGEM
<b>VOLKSWAGEN</b>						
FUSCA	->	CILINDRO DE RODA 17,46mm	1970/1976	C/ EIXO 4 FUROS	C-3375	
FUSCA	->	CILINDRO DE RODA 19,05mm	1977/1996		C-3352	
FUSCA	->	REPARO DO CILINDRO DE RODA 19,05mm	1957/1976	C/ EIXO 5 FUROS	C-1473	
FUSCA	->	REPARO DO CILINDRO DE RODA 17,46mm	1970/1976	C/ EIXO 4 FUROS	C-1475	
FUSCA	->	REPARO DO CILINDRO DE RODA 19,05mm	1977/1996		C-1473	
FUSCA	->	COPO DO CILINDRO DE RODA 19,05mm	1957/1976	C/ EIXO 5 FUROS	CO-1312	
FUSCA	->	COPO DO CILINDRO DE RODA 17,46mm	1970/1976	C/ EIXO 4 FUROS	CO-1305	
FUSCA	->	COPO DO CILINDRO DE RODA 19,05mm	1977/1996		CO-1312	
FUSCA	->	TAPA PÓ DO CILINDRO DE RODA	1957/1996		TA-0329	
GOL (G1)		SERVO FREIO 200mm	1981/1996		C-5600	
GOL (G1)		SERVO FREIO 200mm	1996/1996	C/ SUPORTE EM ALUMÍNIO	C-5620	
GOL (G1)		VÁLVULA DE RETENÇÃO DE VÁCUO BRANCA	1981/1996	P/ SERVO VARGA SM180/SM200	C-1750	
GOL (G1)		VÁLVULA DE RETENÇÃO DE VÁCUO	1981/1996		C-1753	
GOL (G1)		CILINDRO MESTRE DUPLO 20,63mm	1981/1984	C/SERVO	C-2009	
GOL (G1)		CILINDRO MESTRE DUPLO 20,63mm	1985/1996		C-2000	
GOL (G1)		REPARO DO CILINDRO MESTRE DUPLO 20,63mm	1981/1996	C/SERVO	C-1027	
GOL (G1)		REPARO DO CILINDRO MESTRE DUPLO 20,63mm	1988/1996	P/ CILINDRO ATE	C-1116	
GOL (G1)		RESERVATÓRIO C/ TAMPÁ	1981/1984	C/SERVO	C-0108	
GOL (G1)		RESERVATÓRIO C/ TAMPÁ E AVISO DE NÍVEL	1985/1996		C-0102	
GOL (G1)		VEDANTE DO CILINDRO MESTRE	1980/1996		VE-0201	
GOL (G1)	<-	REPARO DE VEDAÇÃO DA PINÇA 44,00mm	1980/1996	MOTOR 1.0/1.3/1.6	C-1493	
GOL (G1)	<-	REPARO DE VEDAÇÃO DA PINÇA 48,00mm	1984/1994	MOTOR 1.8/2.0	C-1443	
GOL (G1)	->	CILINDRO DE RODA 14,28mm	1980/1996		C-3350	
GOL (G1)	->	REPARO DO CILINDRO DE RODA 14,28mm	1980/1996		C-1494	
GOL (G1)	->	GAXETA DO CILINDRO DE RODA 14,28mm	1980/1996		GA-0311	
GOL (G1)	->	TAPA-PÓ DO CILINDRO DE RODA	1980/1996		TA-0338	

BUSCA POR VEÍCULOS

Tabela de Conversão	Polegadas	9/16"	5/8"	11/16"	7/10"	3/4"	13/16"	7/8"	15/16"	1"	1 1/16"	1 1/8"	1 1/4"	1 3/8"	1 1/2"	1 5/8"	1 3/4"	1 27/32"	2"
	Milímetros	14,28mm	15,87mm	17,46mm	17,78mm	19,05mm	20,63mm	22,22mm	23,81mm	25,40mm	26,98mm	28,57mm	31,75mm	34,92mm	38,10mm	41,27mm	44,45mm	46,83mm	50,80mm













VEÍCULO		DESCRIÇÃO	ANOS	OBSERVAÇÃO	REF.	IMAGEM
<b>VOLKSWAGEN</b>						
GOL (G2)		SERVO FREIO 200mm	1995/1995	C/ SUPORTE EM FERRO	C-5600	
GOL (G2)		SERVO FREIO 200mm	1995/2000	C/ABS	C-5650	
GOL (G2)		SERVO FREIO 200mm	1995/2000	MOTOR 2.0 S/ABS	C-5658	
GOL (G2)		SERVO FREIO 200mm	1995/2001	MOTOR 1.0/1.6/1.8 S/ABS	C-5620	
GOL (G2)		SERVO FREIO 200mm	2002/2005	MOTOR 1.0	C-5620	
GOL (G2)		SERVO FREIO 200mm	2002/2005	MOTOR 1.6	C-5661	
GOL (G2)		CILINDRO MESTRE DUPL0 22,22mm	1995/2000	MOTOR 2.0 8V/16V S/ABS	C-2058	
GOL (G2)		CILINDRO MESTRE DUPL0 22,22mm	1995/2000	C/ABS	C-2099	
GOL (G2)		CILINDRO MESTRE DUPL0 20,63mm	1995/2001	MOTOR 1.0/1.6/1.8 S/ABS	C-2000	
GOL (G2)		CILINDRO MESTRE DUPL0 20,63mm	2002/2005	MOTOR 1.0	C-2000	
GOL (G2)		CILINDRO MESTRE DUPL0 22,22mm	2002/2005	MOTOR 1.6	C-2058	
GOL (G2)		REPARO DO CILINDRO MESTRE DUPL0 22,22mm	1995/2000	C/ABS	C-1131	
GOL (G2)		REPARO DO CILINDRO MESTRE DUPL0 22,22mm	1995/2000	MOTOR 2.0 8V/16V S/ABS	C-1143	

Tabela de Conversão	Polegadas	9/16"	5/8"	11/16"	7/10"	3/4"	13/16"	7/8"	15/16"	1"	1 1/16"	1 1/8"	1 1/4"	1 3/8"	1 1/2"	1 5/8"	1 3/4"	1 27/32"	2"
	Milímetros	14,28mm	15,87mm	17,46mm	17,78mm	19,05mm	20,63mm	22,22mm	23,81mm	25,40mm	26,98mm	28,57mm	31,75mm	34,92mm	38,10mm	41,27mm	44,45mm	46,83mm	50,80mm

VEÍCULO		DESCRIÇÃO	ANOS	OBSERVAÇÃO	REF.	IMAGEM
<b>VOLKSWAGEN</b>						
GOL (G2)		REPARO DO CILINDRO MESTRE DUPLO 20,63mm	1995/2005	MOTOR 1.0/1.6/1.8 S/ABS	C-1027	
GOL (G2)		REPARO DO CILINDRO MESTRE DUPLO 20,63mm	1995/2005	MOTOR 1.0/1.6/1.8 C/ CILINDRO ATE	C-1116	
GOL (G2)		REPARO DO CILINDRO MESTRE DUPLO 20,63mm	1995/2005	MOTOR 1.0/1.6/1.8 C/ CILINDRO BENDIX	C-1169	
GOL (G2)		RESERVATÓRIO C/ TAMPA E AVISO DE NÍVEL	1995/2005	EXCETO 2.0 16V E ABS	C-0102	
GOL (G2)		VEDANTE DO CILINDRO MESTRE	1995/2000	C/ABS	VE-0208	
GOL (G2)		VEDANTE DO CILINDRO MESTRE	1995/2005	S/ABS	VE-0201	
GOL (G2)	<-	REPARO DE VEDAÇÃO DA PINÇA 44,00mm	1995/1995	SIST. ATE C/MOTOR 1.0/1.6 S/ABS	C-1493	
GOL (G2)	<-	REPARO DE VEDAÇÃO DA PINÇA 54,00mm	1995/2000	SIST. ATE C/MOTOR 2.0	C-1419	
GOL (G2)	<-	REPARO DE VEDAÇÃO DA PINÇA 54,00mm	1995/2000	SIST. ATE C/ABS	C-1419	
GOL (G2)	<-	REPARO DE VEDAÇÃO DA PINÇA 54,00mm	1995/2000	SIST. VARGA C/MOTOR 2.0	C-1568	
GOL (G2)	<-	REPARO DE VEDAÇÃO DA PINÇA 54,00mm	1995/2000	SIST. VARGA C/ABS	C-1568	
GOL (G2)	<-	REPARO DE VEDAÇÃO DA PINÇA 48,00mm	1995/2005	SIST. ATE C/MOTOR 1.0/1.6/1.8 S/ABS	C-1443	
GOL (G2)	<-	REPARO DE VEDAÇÃO DA PINÇA 48,00mm	1997/2005	SIST. VARGA C/MOTOR 1.0/1.6/1.8 S/ABS	C-1559	
GOL (G2)	<-	TAPA PÓ DO PINO DE GUIA	1995/2000	SIST. VARGA C/MOTOR 2.0	TA-0322	
GOL (G2)	<-	TAPA PÓ DO PINO DE GUIA	1995/2000	SIST. VARGA C/ABS	TA-0322	
GOL (G2)	->	CILINDRO DE RODA 17,46mm	1995/1997	C/ABS	C-3356	
GOL (G2)	->	CILINDRO DE RODA 17,46mm	1995/2000	MOTOR 2.0 S/ABS	C-3356	
GOL (G2)	->	CILINDRO DE RODA 14,28mm	1995/2005	MOTOR 1.0/1.6/1.8 S/ABS	C-3350	
GOL (G2)	->	CILINDRO DE RODA 19,05mm	1998/2000	C/ABS	C-3440	
GOL (G2)	->	REPARO DO CILINDRO DE RODA 17,46mm	1995/1997	C/ABS	C-1446	
GOL (G2)	->	REPARO DO CILINDRO DE RODA 17,46mm	1995/2000	MOTOR 2.0 S/ABS	C-1446	
GOL (G2)	->	REPARO DO CILINDRO DE RODA 14,28mm	1995/2005	MOTOR 1.0/1.6/1.8 S/ABS	C-1494	
GOL (G2)	->	REPARO DO CILINDRO DE RODA 19,05mm	1998/2000	C/ABS	C-1447	
GOL (G2)	->	GAXETA DO CILINDRO DE RODA 17,46mm	1995/1997	C/ABS	GA-0309	
GOL (G2)	->	GAXETA DO CILINDRO DE RODA 17,46mm	1995/2000	MOTOR 2.0 S/ABS	GA-0309	
GOL (G2)	->	GAXETA DO CILINDRO DE RODA 14,28mm	1995/2005	MOTOR 1.0/1.6/1.8 S/ABS	GA-0311	
GOL (G2)	->	GAXETA DO CILINDRO DE RODA 19,05mm	1998/2000	C/ABS	GA-0307	
GOL (G2)	->	TAPA-PÓ DO CILINDRO DE RODA	1995/2005		TA-0338	
GOL (G2)	->	TAPA PÓ DO CILINDRO DE RODA	1998/2000	C/ABS	TA-0343	
GOL (G2)	->	REPARO DE VEDAÇÃO DA PINÇA 33,00mm	1995/2000		C-1546	
GOL (G2)		MANGUEIRA DO FILTRO DE AR	1994/...	MOTOR AP MI	C-9029	
GOL (G2)		JOGO ANÉIS VEDAÇÃO COLETOR DE ADMISSÃO	1997/2000	MOTOR 1.0 16V	C-9509	

Tabela de Conversão	Polegadas	9/16"	5/8"	11/16"	7/10"	3/4"	13/16"	7/8"	15/16"	1"	1 1/16"	1 1/8"	1 1/4"	1 3/8"	1 1/2"	1 5/8"	1 3/4"	1 27/32"	2"
	Milímetros	14,28mm	15,87mm	17,46mm	17,78mm	19,05mm	20,63mm	22,22mm	23,81mm	25,40mm	26,98mm	28,57mm	31,75mm	34,92mm	38,10mm	41,27mm	44,45mm	46,83mm	50,80mm





















VEÍCULO		DESCRIÇÃO	ANOS	OBSERVAÇÃO	REF.	IMAGEM
<b>VOLKSWAGEN</b>						
GOL (G3)		SERVO FREIO 200mm	2000/2000	MOTOR 1.0/1.6/1.8 S/ABS	C-5620	
GOL (G3)		SERVO FREIO 200mm	2000/2000	MOTOR 2.0 S/ABS	C-5658	
GOL (G3)		SERVO FREIO 200mm	2000/2001	MOTOR 1.0/1.6/1.8/2.0 C/ABS	C-5650	
GOL (G3)		SERVO FREIO 230mm	2000/2001	MOTOR 1.0 TURBO	C-5665	
GOL (G3)		SERVO FREIO 200mm	2001/2001	MOTOR 1.0/1.6/1.8/2.0 S/ABS	C-5658	
GOL (G3)		SERVO FREIO 200mm	2002/2005	C/ HASTE TIPO "U"	C-5658	
GOL (G3)		SERVO FREIO 200mm	2002/2005	MOTOR 1.0/1.6/1.8/2.0 S/ABS	C-5661	
GOL (G3)		CILINDRO MESTRE DUPL0 20,63mm	2000/2000	MOTOR 1.0/1.6/1.8 S/ABS	C-2000	
GOL (G3)		CILINDRO MESTRE DUPL0 22,22mm	2000/2000	MOTOR 2.0 8V/16V S/ABS	C-2058	
GOL (G3)		CILINDRO MESTRE DUPL0 22,22mm	2000/2004	MOTOR 1.0 TURBO	C-2099	
GOL (G3)		CILINDRO MESTRE DUPL0 22,22mm	2000/2005	C/ABS	C-2099	

Tabela de Conversão	Polegadas	9/16"	5/8"	11/16"	7/10"	3/4"	13/16"	7/8"	15/16"	1"	1 1/16"	1 1/8"	1 1/4"	1 3/8"	1 1/2"	1 5/8"	1 3/4"	1 27/32"	2"
	Milímetros	14,28mm	15,87mm	17,46mm	17,78mm	19,05mm	20,63mm	22,22mm	23,81mm	25,40mm	26,98mm	28,57mm	31,75mm	34,92mm	38,10mm	41,27mm	44,45mm	46,83mm	50,80mm

VEÍCULO		DESCRIÇÃO	ANOS	OBSERVAÇÃO	REF.	IMAGEM
<b>VOLKSWAGEN</b>						
GOL (G3)		CILINDRO MESTRE DUPL0 22,22mm	2001/2005	MOTOR 1.0/1.6/1.8/2.0 S/ABS	C-2058	
GOL (G3)		REPARO DO CILINDRO MESTRE DUPL0 20,63mm	2000/2000	MOTOR 1.0/1.6/1.8 S/ABS	C-1027	
GOL (G3)		REPARO DO CILINDRO MESTRE DUPL0 20,63mm	2000/2000	SIST. ATE C/MOTOR 1.0/1.6/1.8	C-1116	
GOL (G3)		REPARO DO CILINDRO MESTRE DUPL0 22,22mm	2000/2000	MOTOR 2.0 8V/16V S/ABS	C-1143	
GOL (G3)		REPARO DO CILINDRO MESTRE DUPL0 20,63mm	2000/2000	SIST. BOSCH C/MOTOR 1.0/1.6/1.8	C-1169	
GOL (G3)		REPARO DO CILINDRO MESTRE DUPL0 22,22mm	2000/2004	MOTOR 1.0 TURBO	C-1131	
GOL (G3)		REPARO DO CILINDRO MESTRE DUPL0 22,22mm	2000/2005	C/ABS	C-1131	
GOL (G3)		REPARO DO CILINDRO MESTRE DUPL0 22,22mm	2001/2005	S/ABS	C-1143	
GOL (G3)		RESERVATÓRIO C/ TAMP0 E AVISO DE NÍVEL	2000/2005	EXCETO 1.0 TURBO, 2.0 16V E ABS	C-0102	
GOL (G3)		VEDANTE DO CILINDRO MESTRE	2000/2004	MOTOR 1.0 TURBO	VE-0208	
GOL (G3)		VEDANTE DO CILINDRO MESTRE	2000/2005	S/ABS	VE-0201	
GOL (G3)		VEDANTE DO CILINDRO MESTRE	2000/2005	C/ABS	VE-0208	
GOL (G3)	<-	REPARO DE VEDAÇÃO DA PINÇA 54,00mm	2000/2000	SIST. ATE C/ MOTOR 2.0	C-1419	
GOL (G3)	<-	REPARO DE VEDAÇÃO DA PINÇA 54,00mm	2000/2000	SIST. ATE C/ABS	C-1419	
GOL (G3)	<-	REPARO DE VEDAÇÃO DA PINÇA 48,00mm	2000/2000	SIST. ATE C/ MOTOR 1.0/1.6/1.8 S/ABS	C-1443	
GOL (G3)	<-	REPARO DE VEDAÇÃO DA PINÇA 48,00mm	2000/2000	SIST. VARGA C/ MOTOR 1.0/1.6/1.8 S/ABS	C-1559	
GOL (G3)	<-	REPARO DE VEDAÇÃO DA PINÇA 54,00mm	2000/2000	SIST. VARGA C/ MOTOR 2.0	C-1568	
GOL (G3)	<-	REPARO DE VEDAÇÃO DA PINÇA 54,00mm	2000/2000	SIST. VARGA C/ABS	C-1568	
GOL (G3)	<-	REPARO DE VEDAÇÃO DA PINÇA 54,00mm	2001/2005	SIST. ATE	C-1419	
GOL (G3)	<-	REPARO DE VEDAÇÃO DA PINÇA 54,00mm	2001/2005	SIST. VARGA	C-1568	
GOL (G3)	<-	TAPA PÓ DO PINO DE GUIA	2000/2000	SIST. VARGA C/ MOTOR 2.0	TA-0322	
GOL (G3)	<-	TAPA PÓ DO PINO DE GUIA	2000/2000	SIST. VARGA C/ABS	TA-0322	
GOL (G3)	<-	TAPA PÓ DO PINO DE GUIA	2001/2005	SIST. VARGA	TA-0322	
GOL (G3)	->	CILINDRO DE RODA 17,46mm	2000/2002	MOTOR 2.0 S/ABS	C-3356	
GOL (G3)	->	CILINDRO DE RODA 17,46mm	2000/2004	MOTOR 1.0 TURBO S/ABS	C-3356	
GOL (G3)	->	CILINDRO DE RODA 14,28mm	2000/2005	MOTOR 1.0/1.6/1.8 S/ABS	C-3350	
GOL (G3)	->	CILINDRO DE RODA 19,05mm	2000/2005	C/ABS	C-3440	
GOL (G3)	->	REPARO DO CILINDRO DE RODA 17,46mm	2000/2002	MOTOR 2.0 S/ABS	C-1446	
GOL (G3)	->	REPARO DO CILINDRO DE RODA 17,46mm	2000/2004	MOTOR 1.0 TURBO S/ABS	C-1446	
GOL (G3)	->	REPARO DO CILINDRO DE RODA 19,05mm	2000/2005	C/ABS	C-1447	
GOL (G3)	->	REPARO DO CILINDRO DE RODA 14,28mm	2000/2005	MOTOR 1.0/1.6/1.8 S/ABS	C-1494	
GOL (G3)	->	GAXETA DO CILINDRO DE RODA 17,46mm	2000/2002	MOTOR 2.0 S/ABS	GA-0309	
GOL (G3)	->	GAXETA DO CILINDRO DE RODA 17,46mm	2000/2004	MOTOR 1.0 TURBO S/ABS	GA-0309	
GOL (G3)	->	GAXETA DO CILINDRO DE RODA 19,05mm	2000/2005	C/ABS	GA-0307	
GOL (G3)	->	GAXETA DO CILINDRO DE RODA 14,28mm	2000/2005	MOTOR 1.0/1.6/1.8 S/ABS	GA-0311	
GOL (G3)	->	TAPA-PÓ DO CILINDRO DE RODA	2000/2005	S/ABS	TA-0338	
GOL (G3)	->	TAPA-PÓ DO CILINDRO DE RODA	2000/2005	C/ABS	TA-0343	
GOL (G3)	->	REPARO DE VEDAÇÃO DA PINÇA 33,00mm	2000/2000		C-1546	

BUSCA POR VEÍCULOS

Tabela de Conversão	Polegadas	9/16"	5/8"	11/16"	7/10"	3/4"	13/16"	7/8"	15/16"	1"	1 1/16"	1 1/8"	1 1/4"	1 3/8"	1 1/2"	1 5/8"	1 3/4"	1 27/32"	2"
	Milímetros	14,28mm	15,87mm	17,46mm	17,78mm	19,05mm	20,63mm	22,22mm	23,81mm	25,40mm	26,98mm	28,57mm	31,75mm	34,92mm	38,10mm	41,27mm	44,45mm	46,83mm	50,80mm











VEÍCULO		DESCRIÇÃO	ANOS	OBSERVAÇÃO	REF.	IMAGEM
<b>VOLKSWAGEN</b>						
GOL (G3)		MANGUEIRA DO FILTRO DE AR	1994/...	MOTOR AP MI	C-9029	
GOL (G3)		JOGO ANÉIS VEDAÇÃO COLETOR DE ADMISSÃO	2000/2005	MOTOR 1.0 16V	C-9509	
GOL (G3)		JOGO ANÉIS VEDAÇÃO COLETOR DE ADMISSÃO	2002/2005	MOTOR 1.0 GASOLINA 8V	C-9506	
GOL (G3)		JOGO ANÉIS VEDAÇÃO COLETOR DE ADMISSÃO	2005/2005	MOTOR 1.0 FLEX 8V	C-9506	
GOL (G4)		SERVO FREIO 200mm	2006/...		C-5661	
GOL (G4)		CILINDRO MESTRE DUPLO 22,22mm	2006/...		C-2058	
GOL (G4)		REPARO DO CILINDRO MESTRE DUPLO 22,22mm	2006/...		C-1143	
GOL (G4)		RESERVATÓRIO C/ TAMPA E AVISO DE NÍVEL	2006/...		C-0102	
GOL (G4)		VEDANTE DO CILINDRO MESTRE	2006/...		VE-0201	
GOL (G4)	<-	REPARO DE VEDAÇÃO DA PINÇA 54,00mm	2006/...	SIST. ATE	C-1419	
GOL (G4)	<-	REPARO DE VEDAÇÃO DA PINÇA 54,00mm	2006/...	SIST. VARGA	C-1568	
GOL (G4)	<-	TAPA PÓ DO PINO DE GUIA	2006/...	SIST. VARGA	TA-0322	
GOL (G4)	->	CILINDRO DE RODA 14,28mm	2006/...		C-3350	
GOL (G4)	->	REPARO DO CILINDRO DE RODA 14,28mm	2006/...		C-1494	
GOL (G4)	->	GAXETA DO CILINDRO DE RODA 14,28mm	2006/...		GA-0311	
GOL (G4)	->	TAPA-PÓ DO CILINDRO DE RODA	2006/...		TA-0338	
GOL (G4)		MANGUEIRA DO FILTRO DE AR	1994/...	MOTOR AP MI	C-9029	
GOL (G4)		JOGO ANÉIS VEDAÇÃO COLETOR DE ADMISSÃO	2006/...	MOTOR 1.0 FLEX 8V	C-9506	

Tabela de Conversão	Polegadas	9/16"	5/8"	11/16"	7/10"	3/4"	13/16"	7/8"	15/16"	1"	1 1/16"	1 1/8"	1 1/4"	1 3/8"	1 1/2"	1 5/8"	1 3/4"	1 27/32"	2"
	Milímetros	14,28mm	15,87mm	17,46mm	17,78mm	19,05mm	20,63mm	22,22mm	23,81mm	25,40mm	26,98mm	28,57mm	31,75mm	34,92mm	38,10mm	41,27mm	44,45mm	46,83mm	50,80mm

VEÍCULO		DESCRIÇÃO	ANOS	OBSERVAÇÃO	REF.	IMAGEM
<b>VOLKSWAGEN</b>						
GOL (G5)		CILINDRO MESTRE DE EMBREAGEM 15,87mm	2009/...		C-2657	
GOL (G5)		CILINDRO AUXILIAR DE EMBREAGEM 19,05mm	2009/...		C-2651	
GOL (G5)		SERVO FREIO 230mm	2009/...	SIST. ATE S/ABS	C-5669	
GOL (G5)		CILINDRO MESTRE DUPLO 20,63mm	2009/2012	SIST. ATE S/ABS	C-2173	
GOL (G5)		VEDANTE DO CILINDRO MESTRE	2009/...		VE-0204	
GOL (G5)	->	CILINDRO DE RODA 17,46mm	2009/...	C/ABS	C-3356	
GOL (G5)	->	CILINDRO DE RODA 15,87mm	2009/...	1.0 E 1.6 S/ABS	C-3527	
GOL (G5)	->	REPARO DO CILINDRO DE RODA 17,46mm	2009/...	C/ABS	C-1446	
GOL (G5)	->	GAXETA DO CILINDRO DE RODA 17,46mm	2009/...	C/ABS	GA-0309	
GOL (G5)	->	TAPA-PÓ DO CILINDRO DE RODA	2009/...		TA-0338	
GOLF		CILINDRO MESTRE DE EMBREAGEM 15,87mm	1999/...		C-2650	
GOLF		CILINDRO AUXILIAR DE EMBREAGEM 19,05mm	1999/2000	ACION. P/ CABOS	C-2656	
GOLF		CILINDRO AUXILIAR DE EMBREAGEM 19,05mm	2001/...	MOTOR 1.6 101 CV	C-2651	
GOLF		CILINDRO AUXILIAR DE EMBREAGEM 19,05mm	2001/...	MOTOR 1.8/2.0	C-2656	

BUSCA POR VEÍCULOS

Tabela de Conversão	Polegadas	9/16"	5/8"	11/16"	7/10"	3/4"	13/16"	7/8"	15/16"	1"	1 1/16"	1 1/8"	1 1/4"	1 3/8"	1 1/2"	1 5/8"	1 3/4"	1 27/32"	2"
	Milímetros	14,28mm	15,87mm	17,46mm	17,78mm	19,05mm	20,63mm	22,22mm	23,81mm	25,40mm	26,98mm	28,57mm	31,75mm	34,92mm	38,10mm	41,27mm	44,45mm	46,83mm	50,80mm

VEÍCULO		DESCRIÇÃO	ANOS	OBSERVAÇÃO	REF.	IMAGEM
<b>VOLKSWAGEN</b>						
GOLF		SERVO FREIO 230mm	1994/1998	S/ABS	C-5637	
GOLF		CILINDRO MESTRE DUPL0 22,22mm	1994/1998	MOD. GLX/GTI S/ABS	C-2074	
GOLF		CILINDRO MESTRE DUPL0 20,63mm	1995/1998	MOD. GL	C-2067	
GOLF		CILINDRO MESTRE DUPL0 23,81mm	1999/...		C-2095	
GOLF		REPARO DO CILINDRO MESTRE DUPL0 22,22mm	1994/1998	MOD. GLX/GTI C/CIL. ATE S/ABS	C-1158	
GOLF		REPARO DO CILINDRO MESTRE DUPL0 22,22mm	1994/1998	MOD. GLX/GTI C/CIL. BENDIX S/ABS	C-1163	
GOLF		REPARO DO CILINDRO MESTRE DUPL0 20,63mm	1995/1998	MOD. GL C/CIL. ATE	C-1156	
GOLF		REPARO DO CILINDRO MESTRE DUPL0 20,63mm	1995/1998	MOD. GL C/CIL. BENDIX	C-1168	
GOLF		REPARO DO CILINDRO MESTRE DUPL0 23,81mm	1999/...		C-1172	
GOLF		VEDANTE DO CILINDRO MESTRE	1994/...		VE-0204	
GOLF	<-	REPARO DE VEDAÇÃO DA PINÇA 54,00mm	1994/1998	MOD. GLX/GTI	C-1558	
GOLF	<-	REPARO DE VEDAÇÃO DA PINÇA 54,00mm	1995/1998	MOD. GL (fabr. Alemanha)	C-1558	
GOLF	<-	REPARO DE VEDAÇÃO DA PINÇA 48,00mm	1996/1998	MOD. GL SIST. ATE (fabr. México)	C-1443	
GOLF	<-	REPARO DE VEDAÇÃO DA PINÇA 48,00mm	1996/1998	MOD. GL SIST. GIRLING (fabr. México)	C-1532	
GOLF	<-	REPARO DE VEDAÇÃO DA PINÇA 54,00mm	1999/...		C-1587	
GOLF	<-	TAPA PÓ DO PINO DE GUIA	1994/1998	SIST. GIRLING	TA-0322	
GOLF	->	CILINDRO DE RODA 19,05mm	1995/1998	MOD. GLX	C-3440	
GOLF	->	CILINDRO DE RODA 19,05mm	1995/1998	MOD. GL (fabr. Alemanha)	C-3440	
GOLF	->	CILINDRO DE RODA 17,46mm	1996/1998	MOD. GL (fabr. México)	C-3356	
GOLF	->	REPARO DO CILINDRO DE RODA 19,05mm	1995/1998	MOD. GLX	C-1447	
GOLF	->	REPARO DO CILINDRO DE RODA 19,05mm	1995/1998	MOD. GL (fabr. Alemanha)	C-1447	
GOLF	->	REPARO DO CILINDRO DE RODA 17,46mm	1996/1998	MOD. GL (fabr. México)	C-1446	
GOLF	->	GAXETA DO CILINDRO DE RODA 19,05mm	1995/1998	MOD. GLX	GA-0307	
GOLF	->	GAXETA DO CILINDRO DE RODA 19,05mm	1995/1998	MOD. GL (fabr. Alemanha)	GA-0307	
GOLF	->	GAXETA DO CILINDRO DE RODA 17,46mm	1996/1998	MOD. GL (fabr. México)	GA-0309	
GOLF	->	TAPA PÓ DO CILINDRO DE RODA	1995/1998	MOD. GLX	TA-0343	
GOLF	->	TAPA PÓ DO CILINDRO DE RODA	1995/1998	MOD. GL (fabr. Alemanha)	TA-0343	
GOLF	->	TAPA-PÓ DO CILINDRO DE RODA	1996/1998	MOD. GL (fabr. México)	TA-0338	
GOLF	->	REPARO DE VEDAÇÃO DA PINÇA 38,00mm	1994/1998		C-1549	
GOLF	->	REPARO DE VEDAÇÃO DA PINÇA 38,00mm	1999/...		C-1551	

Tabela de Conversão	Polegadas	9/16"	5/8"	11/16"	7/10"	3/4"	13/16"	7/8"	15/16"	1"	1 1/16"	1 1/8"	1 1/4"	1 3/8"	1 1/2"	1 5/8"	1 3/4"	1 27/32"	2"
	Milímetros	14,28mm	15,87mm	17,46mm	17,78mm	19,05mm	20,63mm	22,22mm	23,81mm	25,40mm	26,98mm	28,57mm	31,75mm	34,92mm	38,10mm	41,27mm	44,45mm	46,83mm	50,80mm

VEÍCULO		DESCRIÇÃO	ANOS	OBSERVAÇÃO	REF.	IMAGEM
<b>VOLKSWAGEN</b>						
GOLF	->	TAPA PÓ DO PINO DE GUIA	1994/1998		TA-0322	
KARMANN GHIA		CILINDRO MESTRE SIMPLES 19,05mm	1957/1966		C-2059	
KARMANN GHIA		CILINDRO MESTRE SIMPLES 17,46mm	1967/1969		C-2003	
KARMANN GHIA		REPARO DO CILINDRO MESTRE SIMPLES 19,05mm	1957/1966		C-1035	
KARMANN GHIA		REPARO DO CILINDRO MESTRE SIMPLES 17,46mm	1967/1969		C-1048	
KARMANN GHIA		VEDANTE DO CILINDRO MESTRE	1967/1969		VE-0201	
KARMANN GHIA	<-	CILINDRO DE RODA 22,22mm	1957/1969		C-3351	
KARMANN GHIA	<-	REPARO DO CILINDRO DE RODA 22,22mm	1957/1969	P/ CILINDRO VARGA RCCR 2157.8	C-1472	
KARMANN GHIA	<-	REPARO DO CILINDRO DE RODA 22,22mm	1957/1969		C-1496	
KARMANN GHIA	<-	COPO DO CILINDRO DE RODA 22,22mm	1957/1969		CO-1315	
KARMANN GHIA	<-	TAPA PÓ DO CILINDRO DE RODA	1957/1969	P/ CILINDRO VARGA RCCR 2157.8	TA-0330	
KARMANN GHIA	<-	TAPA PÓ DO CILINDRO DE RODA	1957/1969		TA-0336	
KARMANN GHIA	->	CILINDRO DE RODA 19,05mm	1957/1969		C-3407	
KARMANN GHIA	->	REPARO DO CILINDRO DE RODA 19,05mm	1957/1969		C-1473	
KARMANN GHIA	->	COPO DO CILINDRO DE RODA 19,05mm	1957/1969		CO-1312	
KARMANN GHIA	->	TAPA PÓ DO CILINDRO DE RODA	1957/1969		TA-0329	
KARMANN GHIA TC	<-	REPARO DE VEDAÇÃO DA PINÇA 40,00mm	1970/1976		C-1498	
KARMANN GHIA TC	->	CILINDRO DE RODA 22,22mm	1970/1976		C-3357	
KARMANN GHIA TC	->	REPARO DO CILINDRO DE RODA 19,05mm	1970/1972	P/ CILINDRO 3/4"	C-1473	
KARMANN GHIA TC	->	REPARO DO CILINDRO DE RODA 22,22mm	1970/1976		C-1496	
KARMANN GHIA TC	->	COPO DO CILINDRO DE RODA 19,05mm	1970/1972	P/ CILINDRO 3/4"	CO-1312	
KARMANN GHIA TC	->	COPO DO CILINDRO DE RODA 22,22mm	1970/1976		CO-1315	
KARMANN GHIA TC	->	TAPA PÓ DO CILINDRO DE RODA	1970/1972	P/ CILINDRO 3/4"	TA-0329	
KARMANN GHIA TC	->	TAPA PÓ DO CILINDRO DE RODA	1970/1976		TA-0336	
KOMBI		SERVO FREIO 200mm	1976/...		C-5607	
KOMBI		VÁLVULA DE RETENÇÃO DE VÁCUO	1976/...		C-1753	
KOMBI		CILINDRO MESTRE SIMPLES 22,22mm	1957/1975		C-2084	
KOMBI		CILINDRO MESTRE SIMPLES 23,81mm	1976/1982		C-2017	

Tabela de Conversão	Polegadas	9/16"	5/8"	11/16"	7/10"	3/4"	13/16"	7/8"	15/16"	1"	1 1/16"	1 1/8"	1 1/4"	1 3/8"	1 1/2"	1 5/8"	1 3/4"	1 27/32"	2"
	Milímetros	14,28mm	15,87mm	17,46mm	17,78mm	19,05mm	20,63mm	22,22mm	23,81mm	25,40mm	26,98mm	28,57mm	31,75mm	34,92mm	38,10mm	41,27mm	44,45mm	46,83mm	50,80mm

VEÍCULO		DESCRIÇÃO	ANOS	OBSERVAÇÃO	REF.	IMAGEM
<b>VOLKSWAGEN</b>						
KOMBI		CILINDRO MESTRE DUPL0 23,81mm	1982/...		C-2018	
KOMBI		REPARO DO CILINDRO MESTRE SIMPLES 22,22mm	1957/1975		C-1049	
KOMBI		REPARO DO CILINDRO MESTRE SIMPLES 23,81mm	1976/1982		C-1079	
KOMBI		REPARO DO CILINDRO MESTRE DUPL0 23,81mm	1982/...		C-1021	
KOMBI		VEDANTE DO CILINDRO MESTRE	1976/...		VE-0201	
KOMBI	<	CILINDRO DE RODA ESQUERDA SUPERIOR 25,40mm	1967/1982		C-3399	
KOMBI	<	CILINDRO DE RODA DIREITA SUPERIOR 25,40mm	1967/1982		C-3400	
KOMBI	<	CILINDRO DE RODA ESQUERDA INFERIOR 25,40mm	1967/1982		C-3401	
KOMBI	<	CILINDRO DE RODA DIREITA INFERIOR 25,40mm	1967/1982		C-3402	
KOMBI	<	REPARO DO CILINDRO DE RODA 25,40mm	1957/1982		C-1477	
KOMBI	<	GAXETA DO CILINDRO DE RODA 25,40mm	1957/1982		GA-0303	
KOMBI	<	TAPA PÓ DO CILINDRO DE RODA	1957/1982		TA-0331	
KOMBI	<	REPARO DE VEDAÇÃO DA PINÇA 54,00mm	1982/...	SIST. ATE	C-1430	
KOMBI	<	REPARO DE VEDAÇÃO DA PINÇA 54,00mm	1997/...	SIST. VARGA	C-1598	
KOMBI	>	CILINDRO DE RODA 22,22mm	1967/1975		C-3403	
KOMBI	>	CILINDRO DE RODA 23,81mm	1976/1982		C-3367	
KOMBI	>	CILINDRO DE RODA 23,81mm	1982/...		C-3366	
KOMBI	>	REPARO DO CILINDRO DE RODA 22,22mm	1957/1975		C-1476	
KOMBI	>	REPARO DO CILINDRO DE RODA 23,81mm	1976/1982		C-1495	
KOMBI	>	REPARO DO CILINDRO DE RODA 23,81mm	1982/...		C-1445	
KOMBI	>	GAXETA DO CILINDRO DE RODA 22,22mm	1957/1975		GA-0314	
KOMBI	>	GAXETA DO CILINDRO DE RODA 23,81mm	1976/...		GA-0308	
KOMBI	>	TAPA PÓ DO CILINDRO DE RODA	1957/1982		TA-0332	

Tabela de Conversão	Polegadas	9/16"	5/8"	11/16"	7/10"	3/4"	13/16"	7/8"	15/16"	1"	1 1/16"	1 1/8"	1 1/4"	1 3/8"	1 1/2"	1 5/8"	1 3/4"	1 27/32"	2"
	Milímetros	14,28mm	15,87mm	17,46mm	17,78mm	19,05mm	20,63mm	22,22mm	23,81mm	25,40mm	26,98mm	28,57mm	31,75mm	34,92mm	38,10mm	41,27mm	44,45mm	46,83mm	50,80mm

VEÍCULO		DESCRIÇÃO	ANOS	OBSERVAÇÃO	REF.	IMAGEM
<b>VOLKSWAGEN</b>						
KOMBI		JOGO ANÉIS VEDAÇÃO COLETOR DE ADMISSÃO	2006/...	MOTOR 1.4 FLEX 8V	C-9506	
LOGUS		SERVO FREIO 230mm	1993/1996	SIST. VARGA	C-5623	
LOGUS		SERVO FREIO 230mm	1993/1996	SIST. BOSCH	C-5624	
LOGUS		CILINDRO MESTRE DUPLA 23,81mm	1993/1996	SIST. VARGA	C-2038	
LOGUS		CILINDRO MESTRE DUPLA 23,81mm	1993/1996	SIST. BOSCH	C-2051	
LOGUS		REPARO DO CILINDRO MESTRE DUPLA 23,81mm	1993/1996	SIST. VARGA	C-1127	
LOGUS		REPARO DO CILINDRO MESTRE DUPLA 23,81mm	1993/1996	SIST. BOSCH	C-1128	
LOGUS		VEDANTE DO CILINDRO MESTRE	1993/1996		VE-0204	
LOGUS	<	REPARO DE VEDAÇÃO DA PINÇA 54,00mm	1993/1996	SIST. ATE	C-1419	
LOGUS	<	REPARO DE VEDAÇÃO DA PINÇA 54,00mm	1993/1996	SIST. BOSCH	C-1575	
LOGUS	->	CILINDRO DE RODA 19,05mm	1993/1996	SIST. VARGA	C-3412	
LOGUS	->	CILINDRO DE RODA ESQUERDA 19,05mm	1993/1996	SIST. BOSCH	C-3435	
LOGUS	->	CILINDRO DE RODA DIREITA 19,05mm	1993/1996	SIST. BOSCH	C-3436	
LOGUS	->	REPARO DO CILINDRO DE RODA 19,05mm	1993/1996	SIST. VARGA	C-1481	
LOGUS	->	REPARO DO CILINDRO DE RODA 19,05mm	1993/1996	SIST. BOSCH	C-1554	
LOGUS	->	COPO DO CILINDRO DE RODA 19,05mm	1993/1996	SIST. BOSCH	CO-1312	
LOGUS	->	GAXETA DO CILINDRO DE RODA 19,05mm	1993/1996	SIST. VARGA	GA-0307	
LOGUS	->	TAPA-PÓ DO CILINDRO DE RODA	1993/1996	SIST. VARGA	TA-0312	
LOGUS	->	TAPA-PÓ DO CILINDRO DE RODA	1993/1996	SIST. BOSCH	TA-0321	
NEW BEETLE		CILINDRO MESTRE DE EMBREAGEM 15,87mm	2000/2010		C-2650	

BUSCA POR VEÍCULOS

Tabela de Conversão	Polegadas	9/16"	5/8"	11/16"	7/10"	3/4"	13/16"	7/8"	15/16"	1"	1 1/16"	1 1/8"	1 1/4"	1 3/8"	1 1/2"	1 5/8"	1 3/4"	1 27/32"	2"
	Milímetros	14,28mm	15,87mm	17,46mm	17,78mm	19,05mm	20,63mm	22,22mm	23,81mm	25,40mm	26,98mm	28,57mm	31,75mm	34,92mm	38,10mm	41,27mm	44,45mm	46,83mm	50,80mm











VEÍCULO		DESCRIÇÃO	ANOS	OBSERVAÇÃO	REF.	IMAGEM
<b>VOLKSWAGEN</b>						
NEW BEETLE		CILINDRO AUXILIAR DE EMBREAGEM 19,05mm	2000/2010		C-2656	
NEW BEETLE		CILINDRO MESTRE DUPLO 23,81mm	2000/2005		C-2095	
NEW BEETLE		REPARO DO CILINDRO MESTRE DUPLO 23,81mm	2000/2005		C-1172	
NEW BEETLE		VEDANTE DO CILINDRO MESTRE	2000/2010		VE-0204	
NEW BEETLE	<-	REPARO DE VEDAÇÃO DA PINÇA 54,00mm	2000/2010		C-1587	
NEW BEETLE	->	REPARO DE VEDAÇÃO DA PINÇA 38,00mm	2000/2010		C-1551	
PARATI (G1)		SERVO FREIO 200mm	1983/1996		C-5600	
PARATI (G1)		VÁLVULA DE RETENÇÃO DE VÁCUO BRANCA	1983/1996	P/ SERVO VARGA SM180/SM200	C-1750	
PARATI (G1)		VÁLVULA DE RETENÇÃO DE VÁCUO	1983/1996		C-1753	
PARATI (G1)		CILINDRO MESTRE DUPLO 20,63mm	1983/1984		C-2009	
PARATI (G1)		CILINDRO MESTRE DUPLO 20,63mm	1985/1996		C-2000	
PARATI (G1)		REPARO DO CILINDRO MESTRE DUPLO 20,63mm	1983/1996		C-1027	
PARATI (G1)		REPARO DO CILINDRO MESTRE DUPLO 20,63mm	1988/1996	P/ CILINDRO ATE	C-1116	
PARATI (G1)		RESERVATÓRIO C/ TAMPAS	1983/1984		C-0108	
PARATI (G1)		RESERVATÓRIO C/ TAMPAS E AVISO DE NÍVEL	1985/1996		C-0102	
PARATI (G1)		VEDANTE DO CILINDRO MESTRE	1983/1996		VE-0201	
PARATI (G1)	<-	REPARO DE VEDAÇÃO DA PINÇA 44,00mm	1983/1996	MOTOR 1.5/1.6	C-1493	
PARATI (G1)	<-	REPARO DE VEDAÇÃO DA PINÇA 48,00mm	1987/1996	MOTOR 1.8	C-1443	
PARATI (G1)	->	CILINDRO DE RODA 17,46mm	1983/1996		C-3356	
PARATI (G1)	->	REPARO DO CILINDRO DE RODA 17,46mm	1983/1996		C-1446	
PARATI (G1)	->	GAXETA DO CILINDRO DE RODA 17,46mm	1983/1996		GA-0309	
PARATI (G1)	->	TAPA-PÓ DO CILINDRO DE RODA	1983/1996		TA-0338	
PARATI (G2, G3 e G4)		SERVO FREIO 200mm	1996/2001	MOTOR 1.0/1.6/1.8/2.0 C/ABS	C-5650	
PARATI (G2, G3 e G4)		SERVO FREIO 200mm	1996/2001	MOTOR 1.0/1.6/1.8/2.0 S/ABS	C-5658	
PARATI (G2, G3 e G4)		SERVO FREIO 230mm	2000/2001	MOTOR 1.0 TURBO	C-5665	

Tabela de Conversão	Polegadas	9/16"	5/8"	11/16"	7/10"	3/4"	13/16"	7/8"	15/16"	1"	1 1/16"	1 1/8"	1 1/4"	1 3/8"	1 1/2"	1 5/8"	1 3/4"	1 27/32"	2"
	Milímetros	14,28mm	15,87mm	17,46mm	17,78mm	19,05mm	20,63mm	22,22mm	23,81mm	25,40mm	26,98mm	28,57mm	31,75mm	34,92mm	38,10mm	41,27mm	44,45mm	46,83mm	50,80mm

VEÍCULO		DESCRIÇÃO	ANOS	OBSERVAÇÃO	REF.	IMAGEM
<b>VOLKSWAGEN</b>						
PARATI (G2, G3 e G4)		SERVO FREIO 200mm	2002/2012	MOTOR 1.0/1.6/1.8/2.0 S/ABS	C-5661	
PARATI (G2, G3 e G4)		CILINDRO MESTRE DUPL0 22,22mm	1996/2012	MOTOR 1.0/1.6/1.8/2.0 S/ABS	C-2058	
PARATI (G2, G3 e G4)		CILINDRO MESTRE DUPL0 22,22mm	1996/2012	C/ABS	C-2099	
PARATI (G2, G3 e G4)		CILINDRO MESTRE DUPL0 22,22mm	2000/2004	MOTOR 1.0 TURBO	C-2099	
PARATI (G2, G3 e G4)		REPARO DO CILINDRO MESTRE DUPL0 22,22mm	1996/2012	C/ABS	C-1131	
PARATI (G2, G3 e G4)		REPARO DO CILINDRO MESTRE DUPL0 22,22mm	1996/2012	S/ABS	C-1143	
PARATI (G2, G3 e G4)		REPARO DO CILINDRO MESTRE DUPL0 22,22mm	2000/2004	MOTOR 1.0 TURBO	C-1131	
PARATI (G2, G3 e G4)		RESERVATÓRIO C/ TAMPA E AVISO DE NÍVEL	1996/2012	EXCETO 1.0 TURBO, 2.0 16V E ABS	C-0102	
PARATI (G2, G3 e G4)		VEDANTE DO CILINDRO MESTRE	1996/2012	S/ABS	VE-0201	
PARATI (G2, G3 e G4)		VEDANTE DO CILINDRO MESTRE	1996/2012	C/ABS	VE-0208	
PARATI (G2, G3 e G4)		VEDANTE DO CILINDRO MESTRE	2000/2004	MOTOR 1.0 TURBO	VE-0208	
PARATI (G2, G3 e G4)	<	REPARO DE VEDAÇÃO DA PINÇA 54,00mm	1996/2012	SIST. ATE	C-1419	
PARATI (G2, G3 e G4)	<	REPARO DE VEDAÇÃO DA PINÇA 54,00mm	1996/2012	SIST. VARGA	C-1568	
PARATI (G2, G3 e G4)	<	TAPA PÓ DO PINO DE GUIA	1996/2012	SIST. VARGA	TA-0322	
PARATI (G2, G3 e G4)	->	CILINDRO DE RODA 17,46mm	1996/1997	C/ABS	C-3356	
PARATI (G2, G3 e G4)	->	CILINDRO DE RODA 19,05mm	1996/2000	S/ABS	C-3440	
PARATI (G2, G3 e G4)	->	CILINDRO DE RODA 19,05mm	1998/2012	C/ABS	C-3440	
PARATI (G2, G3 e G4)	->	CILINDRO DE RODA 20,63mm	2001/2012	S/ABS	C-3471	
PARATI (G2, G3 e G4)	->	REPARO DO CILINDRO DE RODA 17,46mm	1996/1997	C/ABS	C-1446	
PARATI (G2, G3 e G4)	->	REPARO DO CILINDRO DE RODA 19,05mm	1996/2000	S/ABS	C-1447	
PARATI (G2, G3 e G4)	->	REPARO DO CILINDRO DE RODA 19,05mm	1998/2012	C/ABS	C-1447	
PARATI (G2, G3 e G4)	->	REPARO DO CILINDRO DE RODA 20,63mm	2001/2012	S/ABS	C-1583	
PARATI (G2, G3 e G4)	->	GAXETA DO CILINDRO DE RODA 17,46mm	1996/1997	C/ABS	GA-0309	
PARATI (G2, G3 e G4)	->	GAXETA DO CILINDRO DE RODA 19,05mm	1996/2000	S/ABS	GA-0307	
PARATI (G2, G3 e G4)	->	GAXETA DO CILINDRO DE RODA 19,05mm	1998/2012	C/ABS	GA-0307	

BUSCA POR VEÍCULOS

Tabela de Conversão	Polegadas	9/16"	5/8"	11/16"	7/10"	3/4"	13/16"	7/8"	15/16"	1"	1 1/16"	1 1/8"	1 1/4"	1 3/8"	1 1/2"	1 5/8"	1 3/4"	1 27/32"	2"
	Milímetros	14,28mm	15,87mm	17,46mm	17,78mm	19,05mm	20,63mm	22,22mm	23,81mm	25,40mm	26,98mm	28,57mm	31,75mm	34,92mm	38,10mm	41,27mm	44,45mm	46,83mm	50,80mm

VEÍCULO		DESCRIÇÃO	ANOS	OBSERVAÇÃO	REF.	IMAGEM
<b>VOLKSWAGEN</b>						
PARATI (G2, G3 e G4)	->	GAXETA DO CILINDRO DE RODA 20,63mm	2001/2012	S/ABS	GA-0213	
PARATI (G2, G3 e G4)	->	TAPA-PÓ DO CILINDRO DE RODA	1996/1997	C/ABS	TA-0338	
PARATI (G2, G3 e G4)	->	TAPA PÓ DO CILINDRO DE RODA	1996/1997	S/ABS	TA-0343	
PARATI (G2, G3 e G4)	->	TAPA PÓ DO CILINDRO DE RODA	1998/2012		TA-0343	
PARATI (G2, G3 e G4)	->	REPARO DE VEDAÇÃO DA PINÇA 33,00mm	1996/2000		C-1546	
PARATI (G2, G3 e G4)		MANGUEIRA DO FILTRO DE AR	1994/...	MOTOR AP MI	C-9029	
PARATI (G2, G3 e G4)		JOGO ANÉIS VEDAÇÃO COLETOR DE ADMISSÃO	1998/2003	MOTOR 1.0 16V	C-9509	
PASSAT		SERVO FREIO 200mm	1977/1989		C-5604	
PASSAT		VÁLVULA DE RETENÇÃO DE VÁCUO BRANCA	1977/1989	P/ SERVO VARGA FD180/SM180	C-1750	
PASSAT		VÁLVULA DE RETENÇÃO DE VÁCUO	1977/1989		C-1753	
PASSAT		CILINDRO MESTRE DUPL0 20,63mm	1977/1984	C/SERVO	C-2009	
PASSAT		CILINDRO MESTRE DUPL0 20,63mm	1985/1989		C-2015	
PASSAT		CILINDRO MESTRE DUPL0 22,22mm	1991/1997	S/ABS	C-2074	
PASSAT		REPARO DO CILINDRO MESTRE DUPL0 20,63mm	1977/1989	C/SERVO	C-1027	
PASSAT		REPARO DO CILINDRO MESTRE DUPL0 22,22mm	1991/1997	S/ABS C/CIL. ATE	C-1158	
PASSAT		REPARO DO CILINDRO MESTRE DUPL0 22,22mm	1991/1997	S/ABS C/CIL. BENDIX	C-1163	
PASSAT		RESERVATÓRIO C/ TAMP A	1977/1984		C-0108	
PASSAT		RESERVATÓRIO C/ TAMP A E AVISO DE NÍVEL	1985/1989		C-0102	
PASSAT		VEDANTE DO CILINDRO MESTRE	1973/1989		VE-0201	
PASSAT		VEDANTE DO CILINDRO MESTRE	1991/1997	C/ABS E S/ABS	VE-0204	
PASSAT	<-	REPARO DE VEDAÇÃO DA PINÇA 44,00mm	1973/1989	MOTOR 1.5/1.6	C-1493	
PASSAT	<-	REPARO DE VEDAÇÃO DA PINÇA 48,00mm	1985/1989	MOTOR 1.8	C-1443	
PASSAT	<-	REPARO DE VEDAÇÃO DA PINÇA 54,00mm	1991/1997	MOTOR 2.0 4 CIL.	C-1558	
PASSAT	<-	REPARO DE VEDAÇÃO DA PINÇA 54,00mm	1991/1997	MOTOR 2.8 V6	C-1587	
PASSAT	<-	REPARO DE VEDAÇÃO DA PINÇA 54,00mm	1998/2005	MOTOR 1.8	C-1558	
PASSAT	<-	REPARO DE VEDAÇÃO DA PINÇA 57,00mm	1998/2005	MOTOR 1.8/1.8 TURBO/2.8 V6	C-1567	
PASSAT	->	CILINDRO DE RODA 14,28mm	1973/1989		C-3350	
PASSAT	->	REPARO DO CILINDRO DE RODA 14,28mm	1973/1989		C-1494	
PASSAT	->	GAXETA DO CILINDRO DE RODA 14,28mm	1973/1989		GA-0311	
PASSAT	->	TAPA-PÓ DO CILINDRO DE RODA	1973/1989		TA-0338	

Tabela de Conversão	Polegadas	9/16"	5/8"	11/16"	7/10"	3/4"	13/16"	7/8"	15/16"	1"	1 1/16"	1 1/8"	1 1/4"	1 3/8"	1 1/2"	1 5/8"	1 3/4"	1 27/32"	2"
	Milímetros	14,28mm	15,87mm	17,46mm	17,78mm	19,05mm	20,63mm	22,22mm	23,81mm	25,40mm	26,98mm	28,57mm	31,75mm	34,92mm	38,10mm	41,27mm	44,45mm	46,83mm	50,80mm











VEÍCULO		DESCRIÇÃO	ANOS	OBSERVAÇÃO	REF.	IMAGEM
<b>VOLKSWAGEN</b>						
PASSAT	->	REPARO DE VEDAÇÃO DA PINÇA 38,00mm	1991/1997		C-1549	
PASSAT	->	REPARO DE VEDAÇÃO DA PINÇA 38,00mm	1998/2005		C-1551	
PASSAT	->	TAPA PÓ DO PINO DE GUIA	1991/1997		TA-0322	
PASSAT VARIANT		CILINDRO MESTRE DUPLO 22,22mm	1991/1997	S/ABS	C-2074	
PASSAT VARIANT		REPARO DO CILINDRO MESTRE DUPLO 22,22mm	1991/1997	S/ABS C/CIL. ATE	C-1158	
PASSAT VARIANT		REPARO DO CILINDRO MESTRE DUPLO 22,22mm	1991/1997	S/ABS C/CIL. BENDIX	C-1163	
PASSAT VARIANT		VEDANTE DO CILINDRO MESTRE	1991/1997	C/ABS E S/ABS	VE-0204	
PASSAT VARIANT	<-	REPARO DE VEDAÇÃO DA PINÇA 54,00mm	1991/1997	MOTOR 2.0 4 CIL.	C-1558	
PASSAT VARIANT	<-	REPARO DE VEDAÇÃO DA PINÇA 54,00mm	1991/1997	MOTOR 2.8 V6	C-1587	
PASSAT VARIANT	<-	REPARO DE VEDAÇÃO DA PINÇA 54,00mm	1998/2005	MOTOR 1.8	C-1558	
PASSAT VARIANT	<-	REPARO DE VEDAÇÃO DA PINÇA 57,00mm	1998/2005	MOTOR 1.8/1.8 TURBO/2.8 V6	C-1567	
PASSAT VARIANT	->	REPARO DE VEDAÇÃO DA PINÇA 38,00mm	1991/1997		C-1549	
PASSAT VARIANT	->	REPARO DE VEDAÇÃO DA PINÇA 38,00mm	1998/2005		C-1551	
PASSAT VARIANT	->	TAPA PÓ DO PINO DE GUIA	1991/1997		TA-0322	
POINTER		SERVO FREIO 230mm	1994/1996	SIST. VARGA	C-5623	
POINTER		SERVO FREIO 230mm	1994/1996	SIST. BOSCH	C-5624	
POINTER		CILINDRO MESTRE DUPLO 23,81mm	1994/1996	SIST. VARGA	C-2038	
POINTER		CILINDRO MESTRE DUPLO 23,81mm	1994/1996	SIST. BOSCH	C-2051	
POINTER		REPARO DO CILINDRO MESTRE DUPLO 23,81mm	1994/1996	SIST. VARGA	C-1127	
POINTER		REPARO DO CILINDRO MESTRE DUPLO 23,81mm	1994/1996	SIST. BOSCH	C-1128	
POINTER		VEDANTE DO CILINDRO MESTRE	1994/1996		VE-0204	
POINTER	<-	REPARO DE VEDAÇÃO DA PINÇA 54,00mm	1994/1996	SIST. ATE	C-1419	
POINTER	<-	REPARO DE VEDAÇÃO DA PINÇA 60,00mm	1994/1996	MOD. GTI	C-1545	
POINTER	<-	REPARO DE VEDAÇÃO DA PINÇA 54,00mm	1994/1996	SIST. BOSCH	C-1575	
POINTER	->	CILINDRO DE RODA 19,05mm	1994/1996	SIST. VARGA	C-3412	
POINTER	->	CILINDRO DE RODA ESQUERDA 19,05mm	1994/1996	SIST. BOSCH	C-3435	

BUSCA POR VEÍCULOS

Tabela de Conversão	Polegadas	9/16"	5/8"	11/16"	7/10"	3/4"	13/16"	7/8"	15/16"	1"	1 1/16"	1 1/8"	1 1/4"	1 3/8"	1 1/2"	1 5/8"	1 3/4"	1 27/32"	2"
	Milímetros	14,28mm	15,87mm	17,46mm	17,78mm	19,05mm	20,63mm	22,22mm	23,81mm	25,40mm	26,98mm	28,57mm	31,75mm	34,92mm	38,10mm	41,27mm	44,45mm	46,83mm	50,80mm

VEÍCULO		DESCRIÇÃO	ANOS	OBSERVAÇÃO	REF.	IMAGEM
<b>VOLKSWAGEN</b>						
POINTER	->	CILINDRO DE RODA DIREITA 19,05mm	1994/1996	SIST. BOSCH	C-3436	
POINTER	->	REPARO DO CILINDRO DE RODA 19,05mm	1994/1996	SIST. VARGA	C-1481	
POINTER	->	REPARO DO CILINDRO DE RODA 19,05mm	1994/1996	SIST. BOSCH	C-1554	
POINTER	->	COPO DO CILINDRO DE RODA 19,05mm	1994/1996	SIST. BOSCH	CO-1312	
POINTER	->	GAXETA DO CILINDRO DE RODA 19,05mm	1994/1996	SIST. VARGA	GA-0307	
POINTER	->	TAPA-PÓ DO CILINDRO DE RODA	1994/1996	SIST. VARGA	TA-0312	
POINTER	->	TAPA-PÓ DO CILINDRO DE RODA	1994/1996	SIST. BOSCH	TA-0321	
POINTER	->	REPARO DE VEDAÇÃO DA PINÇA 33,00mm	1994/1996		C-1546	
POLO		CILINDRO MESTRE DE EMBREAGEM 15,87mm	2002/...		C-2657	
POLO		CILINDRO AUXILIAR DE EMBREAGEM 19,05mm	2002/...		C-2651	
POLO		CILINDRO MESTRE DUPLA 20,63mm	2002/...	S/ABS	C-2160	
POLO	<-	REPARO DE VEDAÇÃO DA PINÇA 54,00mm	2002/...	SIST. LUCAS	C-1558	
POLO	->	CILINDRO DE RODA 17,46mm	2002/...		C-3356	
POLO	->	REPARO DO CILINDRO DE RODA 17,46mm	2002/...		C-1446	
POLO	->	GAXETA DO CILINDRO DE RODA 17,46mm	2002/...		GA-0309	
POLO	->	TAPA-PÓ DO CILINDRO DE RODA	2002/...		TA-0338	
POLO	->	REPARO DE VEDAÇÃO DA PINÇA 38,00mm	2002/...		C-1551	
POLO		MANGUEIRA DO FILTRO DE AR	2007/...	MOTOR POWER	C-9033	
POLO		JOGO ANÉIS VEDAÇÃO COLETOR DE ADMISSÃO	2003/2003	MOTOR 1.0 16V	C-9509	
POLO CLASSIC		CILINDRO AUXILIAR DE EMBREAGEM 19,05mm	2001/2002		C-2656	
POLO CLASSIC		SERVO FREIO 230mm	1997/2002		C-5643	

Tabela de Conversão	Polegadas	9/16"	5/8"	11/16"	7/10"	3/4"	13/16"	7/8"	15/16"	1"	1 1/16"	1 1/8"	1 1/4"	1 3/8"	1 1/2"	1 5/8"	1 3/4"	1 27/32"	2"
	Milímetros	14,28mm	15,87mm	17,46mm	17,78mm	19,05mm	20,63mm	22,22mm	23,81mm	25,40mm	26,98mm	28,57mm	31,75mm	34,92mm	38,10mm	41,27mm	44,45mm	46,83mm	50,80mm

VEÍCULO		DESCRIÇÃO	ANOS	OBSERVAÇÃO	REF.	IMAGEM
<b>VOLKSWAGEN</b>						
POLO CLASSIC		CILINDRO MESTRE DUPL0 22,22mm	1997/2002	S/ABS	C-2074	
POLO CLASSIC		REPARO DO CILINDRO MESTRE DUPL0 22,22mm	1997/2002	S/ABS C/CIL. ATE	C-1158	
POLO CLASSIC		REPARO DO CILINDRO MESTRE DUPL0 22,22mm	1997/2002	S/ABS C/CIL. BENDIX	C-1163	
POLO CLASSIC		VEDANTE DO CILINDRO MESTRE	1997/2002		VE-0204	
POLO CLASSIC	<-	REPARO DE VEDAÇÃO DA PINÇA 54,00mm	1997/2002		C-1558	
POLO CLASSIC	->	CILINDRO DE RODA 19,05mm	1997/2002		C-3440	
POLO CLASSIC	->	REPARO DO CILINDRO DE RODA 19,05mm	1997/2002		C-1447	
POLO CLASSIC	->	GAXETA DO CILINDRO DE RODA 19,05mm	1997/2002		GA-0307	
POLO CLASSIC	->	TAPA PÓ DO CILINDRO DE RODA	1997/2002		TA-0343	
POLO CLASSIC		JOGO ANÉIS VEDAÇÃO COLETOR DE ADMISSÃO	2001/2001	MOTOR 1.0 16V	C-9509	
QUANTUM		SERVO FREIO 230mm	1985/2002	SIST. VARGA E BOSCH S/ABS	C-5608	
QUANTUM		SERVO FREIO 230mm	1992/2002	C/ABS	C-5652	
QUANTUM		VÁLVULA DE RETENÇÃO DE VÁCUO BRANCA	1985/2002	P/ SERVO VARGA	C-1750	
QUANTUM		VÁLVULA DE RETENÇÃO DE VÁCUO	1985/2002		C-1753	
QUANTUM		CILINDRO MESTRE DUPL0 20,63mm	1985/1990		C-2055	
QUANTUM		CILINDRO MESTRE DUPL0 20,63mm	1991/1994	S/ABS	C-2066	
QUANTUM		CILINDRO MESTRE DUPL0 22,22mm	1992/2002	C/ABS	C-2099	
QUANTUM		CILINDRO MESTRE DUPL0 22,22mm	1995/2002	SIST. VARGA E BOSCH S/ABS	C-2060	
QUANTUM		REPARO DO CILINDRO MESTRE DUPL0 20,63mm	1985/1994	S/ABS	C-1055	
QUANTUM		REPARO DO CILINDRO MESTRE DUPL0 22,22mm	1992/2002	C/ABS	C-1131	
QUANTUM		REPARO DO CILINDRO MESTRE DUPL0 22,22mm	1995/2002	S/ABS	C-1137	

BUSCA POR VEÍCULOS

Tabela de Conversão	Polegadas	9/16"	5/8"	11/16"	7/10"	3/4"	13/16"	7/8"	15/16"	1"	1 1/16"	1 1/8"	1 1/4"	1 3/8"	1 1/2"	1 5/8"	1 3/4"	1 27/32"	2"
	Milímetros	14,28mm	15,87mm	17,46mm	17,78mm	19,05mm	20,63mm	22,22mm	23,81mm	25,40mm	26,98mm	28,57mm	31,75mm	34,92mm	38,10mm	41,27mm	44,45mm	46,83mm	50,80mm









VEÍCULO		DESCRIÇÃO	ANOS	OBSERVAÇÃO	REF.	IMAGEM
<b>VOLKSWAGEN</b>						
QUANTUM		REPARO DO CILINDRO MESTRE DUPL0 22,22mm	1995/2002	P/ CILINDRO BOSCH S/ABS	C-1144	
QUANTUM		RESERVATÓRIO C/ TAMP A E AVISO DE NÍVEL	1985/2002	S/ABS	C-0107	
QUANTUM		VEDANTE DO CILINDRO MESTRE	1985/2002	S/ABS	VE-0201	
QUANTUM		VEDANTE DO CILINDRO MESTRE	1992/2002	C/ABS	VE-0208	
QUANTUM	<-	REPARO DE VEDAÇÃO DA PINÇA 48,00mm	1985/1994		C-1443	
QUANTUM	<-	REPARO DE VEDAÇÃO DA PINÇA 54,00mm	1995/2002	SIST. ATE	C-1419	
QUANTUM	<-	REPARO DE VEDAÇÃO DA PINÇA 54,00mm	1995/2002	SIST. VARGA	C-1568	
QUANTUM	<-	TAPA PÓ DO PINO DE GUIA	1995/2002	SIST. VARGA	TA-0322	
QUANTUM	->	CILINDRO DE RODA 17,46mm	1985/2002		C-3356	
QUANTUM	->	REPARO DO CILINDRO DE RODA 17,46mm	1985/2002		C-1446	
QUANTUM	->	GAXETA DO CILINDRO DE RODA 17,46mm	1985/2002		GA-0309	
QUANTUM	->	TAPA-PÓ DO CILINDRO DE RODA	1985/2002		TA-0338	
SANTANA		SERVO FREIO 230mm	1984/2006	SIST. VARGA E BOSCH S/ABS	C-5608	
SANTANA		SERVO FREIO 230mm	1992/2006	C/ABS	C-5652	
SANTANA		VÁLVULA DE RETENÇÃO DE VÁCUO BRANCA	1984/2006	P/ SERVO VARGA	C-1750	
SANTANA		VÁLVULA DE RETENÇÃO DE VÁCUO	1984/2006		C-1753	
SANTANA		CILINDRO MESTRE DUPL0 20,63mm	1984/1990	SIST. VARGA E BOSCH S/ABS	C-2009	
SANTANA		CILINDRO MESTRE DUPL0 20,63mm	1991/1994	SIST. VARGA E BOSCH S/ABS	C-2015	
SANTANA		CILINDRO MESTRE DUPL0 22,22mm	1992/2006	C/ABS	C-2099	
SANTANA		CILINDRO MESTRE DUPL0 22,22mm	1995/2006	SIST. VARGA E BOSCH S/ABS	C-2060	
SANTANA		REPARO DO CILINDRO MESTRE DUPL0 20,63mm	1984/1994	S/ABS	C-1027	
SANTANA		REPARO DO CILINDRO MESTRE DUPL0 22,22mm	1992/2006	C/ABS	C-1131	
SANTANA		REPARO DO CILINDRO MESTRE DUPL0 22,22mm	1995/2006	S/ABS	C-1137	
SANTANA		REPARO DO CILINDRO MESTRE DUPL0 22,22mm	1995/2006	P/ CILINDRO BOSCH S/ABS	C-1144	
SANTANA		RESERVATÓRIO C/ TAMP A E AVISO DE NÍVEL	1984/2006	S/ABS	C-0107	
SANTANA		VEDANTE DO CILINDRO MESTRE	1984/2006	S/ABS	VE-0201	
SANTANA		VEDANTE DO CILINDRO MESTRE	1992/2006	C/ABS	VE-0208	
SANTANA	<-	REPARO DE VEDAÇÃO DA PINÇA 48,00mm	1984/1994		C-1443	
SANTANA	<-	REPARO DE VEDAÇÃO DA PINÇA 54,00mm	1995/2006	SIST. ATE	C-1419	
SANTANA	<-	REPARO DE VEDAÇÃO DA PINÇA 54,00mm	1995/2006	SIST. VARGA	C-1568	

Tabela de Conversão	Polegadas	9/16"	5/8"	11/16"	7/10"	3/4"	13/16"	7/8"	15/16"	1"	1 1/16"	1 1/8"	1 1/4"	1 3/8"	1 1/2"	1 5/8"	1 3/4"	1 27/32"	2"
	Milímetros	14,28mm	15,87mm	17,46mm	17,78mm	19,05mm	20,63mm	22,22mm	23,81mm	25,40mm	26,98mm	28,57mm	31,75mm	34,92mm	38,10mm	41,27mm	44,45mm	46,83mm	50,80mm

VEÍCULO		DESCRIÇÃO	ANOS	OBSERVAÇÃO	REF.	IMAGEM
<b>VOLKSWAGEN</b>						
SANTANA	<-	TAPA PÓ DO PINO DE GUIA	1995/2006	SIST. VARGA	TA-0322	
SANTANA	->	CILINDRO DE RODA 14,28mm	1984/1994		C-3350	
SANTANA	->	CILINDRO DE RODA 17,46mm	1984/1994	C/ CÂMBIO AUTOMÁTICO	C-3356	
SANTANA	->	CILINDRO DE RODA 17,46mm	1995/2006		C-3356	
SANTANA	->	REPARO DO CILINDRO DE RODA 17,46mm	1984/1994	C/ CÂMBIO AUTOMÁTICO	C-1446	
SANTANA	->	REPARO DO CILINDRO DE RODA 14,28mm	1984/1994		C-1494	
SANTANA	->	REPARO DO CILINDRO DE RODA 17,46mm	1995/2006		C-1446	
SANTANA	->	GAXETA DO CILINDRO DE RODA 17,46mm	1984/1994	C/ CÂMBIO AUTOMÁTICO	GA-0309	
SANTANA	->	GAXETA DO CILINDRO DE RODA 14,28mm	1984/1994		GA-0311	
SANTANA	->	GAXETA DO CILINDRO DE RODA 17,46mm	1995/2006		GA-0309	
SANTANA	->	TAPA-PÓ DO CILINDRO DE RODA	1984/2006		TA-0338	
SAVEIRO (G1)		SERVO FREIO 200mm	1982/1996		C-5600	
SAVEIRO (G1)		SERVO FREIO 200mm	1997/1997		C-5620	
SAVEIRO (G1)		VÁLVULA DE RETENÇÃO DE VÁCUO BRANCA	1982/1997	P/ SERVO VARGA FD180/SM180/ SM200	C-1750	
SAVEIRO (G1)		VÁLVULA DE RETENÇÃO DE VÁCUO	1982/1997		C-1753	
SAVEIRO (G1)		CILINDRO MESTRE DUPLA 20,63mm	1982/1984		C-2009	
SAVEIRO (G1)		CILINDRO MESTRE DUPLA 20,63mm	1984/1985		C-2015	
SAVEIRO (G1)		CILINDRO MESTRE DUPLA 20,63mm	1985/1997		C-2000	
SAVEIRO (G1)		REPARO DO CILINDRO MESTRE DUPLA 20,63mm	1982/1997		C-1027	
SAVEIRO (G1)		REPARO DO CILINDRO MESTRE DUPLA 20,63mm	1988/1997	P/ CILINDRO ATE	C-1116	
SAVEIRO (G1)		RESERVATÓRIO C/ TAMPÁ	1982/1984		C-0108	
SAVEIRO (G1)		RESERVATÓRIO C/ TAMPÁ E AVISO DE NÍVEL	1985/1997		C-0102	
SAVEIRO (G1)		VEDANTE DO CILINDRO MESTRE	1982/1997		VE-0201	
SAVEIRO (G1)	<-	REPARO DE VEDAÇÃO DA PINÇA 44,00mm	1982/1997	MOTOR 1.6	C-1493	
SAVEIRO (G1)	<-	REPARO DE VEDAÇÃO DA PINÇA 48,00mm	1990/1997	MOTOR 1.8 SIST. ATE	C-1443	

BUSCA POR VEÍCULOS

Tabela de Conversão	Polegadas	9/16"	5/8"	11/16"	7/10"	3/4"	13/16"	7/8"	15/16"	1"	1 1/16"	1 1/8"	1 1/4"	1 3/8"	1 1/2"	1 5/8"	1 3/4"	1 27/32"	2"
	Milímetros	14,28mm	15,87mm	17,46mm	17,78mm	19,05mm	20,63mm	22,22mm	23,81mm	25,40mm	26,98mm	28,57mm	31,75mm	34,92mm	38,10mm	41,27mm	44,45mm	46,83mm	50,80mm











VEÍCULO		DESCRIÇÃO	ANOS	OBSERVAÇÃO	REF.	IMAGEM
<b>VOLKSWAGEN</b>						
SAVEIRO (G1)	<-	REPARO DE VEDAÇÃO DA PINÇA 48,00mm	1997/1997	MOTOR 1.8 SIST. VARGA	C-1559	
SAVEIRO (G1)	->	CILINDRO DE RODA 19,05mm	1982/1986		C-3440	
SAVEIRO (G1)	->	CILINDRO DE RODA 17,46mm	1987/1997		C-3356	
SAVEIRO (G1)	->	REPARO DO CILINDRO DE RODA 19,05mm	1982/1986		C-1447	
SAVEIRO (G1)	->	REPARO DO CILINDRO DE RODA 17,46mm	1987/1997		C-1446	
SAVEIRO (G1)	->	GAXETA DO CILINDRO DE RODA 19,05mm	1982/1986		GA-0307	
SAVEIRO (G1)	->	GAXETA DO CILINDRO DE RODA 17,46mm	1987/1997		GA-0309	
SAVEIRO (G1)	->	TAPA PÓ DO CILINDRO DE RODA	1982/1986		TA-0343	
SAVEIRO (G1)	->	TAPA-PÓ DO CILINDRO DE RODA	1987/1997		TA-0338	
SAVEIRO (G2, G3 e G4)		SERVO FREIO 200mm	1998/2001	S/ABS	C-5658	
SAVEIRO (G2, G3 e G4)		SERVO FREIO 200mm	1999/2001	C/ABS	C-5650	
SAVEIRO (G2, G3 e G4)		SERVO FREIO 200mm	2002/2009	S/ABS	C-5661	
SAVEIRO (G2, G3 e G4)		CILINDRO MESTRE DUPLA 22,22mm	1998/2009	S/ABS	C-2058	
SAVEIRO (G2, G3 e G4)		CILINDRO MESTRE DUPLA 22,22mm	1999/2009	C/ABS	C-2099	
SAVEIRO (G2, G3 e G4)		REPARO DO CILINDRO MESTRE DUPLA 22,22mm	1998/2009	S/ABS	C-1143	
SAVEIRO (G2, G3 e G4)		REPARO DO CILINDRO MESTRE DUPLA 22,22mm	1999/2009	C/ABS	C-1131	
SAVEIRO (G2, G3 e G4)		RESERVATÓRIO C/ TAMPA E AVISO DE NÍVEL	1998/2009	S/ABS	C-0102	
SAVEIRO (G2, G3 e G4)		VEDANTE DO CILINDRO MESTRE	1998/2009	S/ABS	VE-0201	
SAVEIRO (G2, G3 e G4)		VEDANTE DO CILINDRO MESTRE	1999/2009	C/ABS	VE-0208	
SAVEIRO (G2, G3 e G4)	<-	REPARO DE VEDAÇÃO DA PINÇA 54,00mm	1998/2009	SIST. ATE	C-1419	
SAVEIRO (G2, G3 e G4)	<-	REPARO DE VEDAÇÃO DA PINÇA 54,00mm	1998/2009	SIST. VARGA	C-1568	
SAVEIRO (G2, G3 e G4)	<-	TAPA PÓ DO PINO DE GUIA	1998/2009	SIST. VARGA	TA-0322	
SAVEIRO (G2, G3 e G4)	->	CILINDRO DE RODA 19,05mm	1998/1998		C-3440	

Tabela de Conversão	Polegadas	9/16"	5/8"	11/16"	7/10"	3/4"	13/16"	7/8"	15/16"	1"	1 1/16"	1 1/8"	1 1/4"	1 3/8"	1 1/2"	1 5/8"	1 3/4"	1 27/32"	2"
	Milímetros	14,28mm	15,87mm	17,46mm	17,78mm	19,05mm	20,63mm	22,22mm	23,81mm	25,40mm	26,98mm	28,57mm	31,75mm	34,92mm	38,10mm	41,27mm	44,45mm	46,83mm	50,80mm

VEÍCULO		DESCRIÇÃO	ANOS	OBSERVAÇÃO	REF.	IMAGEM
<b>VOLKSWAGEN</b>						
SAVEIRO (G2, G3 e G4)	->	CILINDRO DE RODA 20,63mm	1998/2009		C-3471	
SAVEIRO (G2, G3 e G4)	->	CILINDRO DE RODA 19,05mm	2000/2009	C/ABS	C-3440	
SAVEIRO (G2, G3 e G4)	->	REPARO DO CILINDRO DE RODA 19,05mm	1998/1998		C-1447	
SAVEIRO (G2, G3 e G4)	->	REPARO DO CILINDRO DE RODA 20,63mm	1998/2009		C-1583	
SAVEIRO (G2, G3 e G4)	->	REPARO DO CILINDRO DE RODA 19,05mm	2000/2009	C/ABS	C-1447	
SAVEIRO (G2, G3 e G4)	->	GAXETA DO CILINDRO DE RODA 19,05mm	1998/1998		GA-0307	
SAVEIRO (G2, G3 e G4)	->	GAXETA DO CILINDRO DE RODA 20,63mm	1998/2009		GA-0213	
SAVEIRO (G2, G3 e G4)	->	GAXETA DO CILINDRO DE RODA 19,05mm	2000/2009	C/ABS	GA-0307	
SAVEIRO (G2, G3 e G4)	->	TAPA PÓ DO CILINDRO DE RODA	1998/2009		TA-0343	
SAVEIRO (G2, G3 e G4)		MANGUEIRA DO FILTRO DE AR	1994/...	MOTOR AP MI	C-9029	
SAVEIRO (G5)		CILINDRO MESTRE DE EMBREAGEM 15,87mm	2010/...		C-2657	
SAVEIRO (G5)		CILINDRO AUXILIAR DE EMBREAGEM 19,05mm	2010/...		C-2651	
SAVEIRO (G5)		SERVO FREIO 230mm	2010/...	SIST. ATE S/ABS	C-5669	
SAVEIRO (G5)		CILINDRO MESTRE DUPLA 20,63mm	2010/2013	SIST. ATE S/ABS	C-2173	
SAVEIRO (G5)	->	CILINDRO DE RODA 19,05mm	2010/...	1KN	C-3440	
SAVEIRO (G5)	->	CILINDRO DE RODA 20,63mm	2010/...	1KM	C-3480	
SAVEIRO (G5)	->	REPARO DO CILINDRO DE RODA 19,05mm	2010/...	1KN	C-1447	
SAVEIRO (G5)	->	REPARO DO CILINDRO DE RODA 20,63mm	2010/...	1KM	C-1593	
SAVEIRO (G5)	->	GAXETA DO CILINDRO DE RODA 20,63mm	2010/...	1KM	GA-0217	
SAVEIRO (G5)	->	GAXETA DO CILINDRO DE RODA 19,05mm	2010/...	1KN	GA-0307	
SAVEIRO (G5)	->	TAPA PÓ DO CILINDRO DE RODA	2010/...		TA-0343	

Tabela de Conversão	Polegadas	9/16"	5/8"	11/16"	7/10"	3/4"	13/16"	7/8"	15/16"	1"	1 1/16"	1 1/8"	1 1/4"	1 3/8"	1 1/2"	1 5/8"	1 3/4"	1 27/32"	2"
	Milímetros	14,28mm	15,87mm	17,46mm	17,78mm	19,05mm	20,63mm	22,22mm	23,81mm	25,40mm	26,98mm	28,57mm	31,75mm	34,92mm	38,10mm	41,27mm	44,45mm	46,83mm	50,80mm

VEÍCULO		DESCRIÇÃO	ANOS	OBSERVAÇÃO	REF.	IMAGEM
<b>VOLKSWAGEN</b>						
SEDAN 1600 4 PORTAS		CILINDRO MESTRE SIMPLES 19,05mm	1969/1971		C-2005	
SEDAN 1600 4 PORTAS		REPARO DO CILINDRO MESTRE SIMPLES 19,05mm	1969/1971		C-1061	
SEDAN 1600 4 PORTAS		VEDANTE DO CILINDRO MESTRE	1969/1971		VE-0201	
SEDAN 1600 4 PORTAS	<-	REPARO DE VEDAÇÃO DA PINÇA 40,00mm	1969/1971		C-1498	
SEDAN 1600 4 PORTAS	->	CILINDRO DE RODA 22,22mm	1969/1971		C-3357	
SEDAN 1600 4 PORTAS	->	REPARO DO CILINDRO DE RODA 19,05mm	1969/1971	P/ CILINDRO 3/4"	C-1473	
SEDAN 1600 4 PORTAS	->	REPARO DO CILINDRO DE RODA 22,22mm	1969/1971		C-1496	
SEDAN 1600 4 PORTAS	->	COPO DO CILINDRO DE RODA 19,05mm	1969/1971	P/ CILINDRO 3/4"	CO-1312	
SEDAN 1600 4 PORTAS	->	COPO DO CILINDRO DE RODA 22,22mm	1969/1971		CO-1315	
SEDAN 1600 4 PORTAS	->	TAPA PÓ DO CILINDRO DE RODA	1969/1971	P/ CILINDRO 3/4"	TA-0329	
SEDAN 1600 4 PORTAS	->	TAPA PÓ DO CILINDRO DE RODA	1969/1971		TA-0336	
SP-1/SP-2		REPARO DO CILINDRO MESTRE DUPL0 19,05mm	1972/1975		C-1060	
SP-1/SP-2		VEDANTE DO CILINDRO MESTRE	1972/1975		VE-0201	
SP-1/SP-2	->	CILINDRO DE RODA 22,22mm	1972/1975		C-3357	
SP-1/SP-2	->	REPARO DO CILINDRO DE RODA 22,22mm	1972/1975		C-1496	
SP-1/SP-2	->	COPO DO CILINDRO DE RODA 22,22mm	1972/1975		CO-1315	
SP-1/SP-2	->	TAPA PÓ DO CILINDRO DE RODA	1972/1975		TA-0336	
SPACEFOX		CILINDRO MESTRE DE EMBREAGEM 15,87mm	2006/...		C-2657	
SPACEFOX		CILINDRO AUXILIAR DE EMBREAGEM 19,05mm	2006/...		C-2651	
SPACEFOX		CILINDRO MESTRE DUPL0 20,63mm	2006/...	S/ABS	C-2160	
SPACEFOX	<-	REPARO DE VEDAÇÃO DA PINÇA 54,00mm	2006/...		C-1587	
SPACEFOX	->	CILINDRO DE RODA 19,05mm	2006/...		C-3440	
SPACEFOX	->	REPARO DO CILINDRO DE RODA 19,05mm	2006/...		C-1447	
SPACEFOX	->	GAXETA DO CILINDRO DE RODA 19,05mm	2006/...		GA-0307	
SPACEFOX	->	TAPA PÓ DO CILINDRO DE RODA	2006/...		TA-0343	
SPACE CROSS		CILINDRO MESTRE DE EMBREAGEM 15,87mm	2012/...		C-2657	
SPACE CROSS		CILINDRO AUXILIAR DE EMBREAGEM 19,05mm	2012/...		C-2651	

Tabela de Conversão	Polegadas	9/16"	5/8"	11/16"	7/10"	3/4"	13/16"	7/8"	15/16"	1"	1 1/16"	1 1/8"	1 1/4"	1 3/8"	1 1/2"	1 5/8"	1 3/4"	1 27/32"	2"
	Milímetros	14,28mm	15,87mm	17,46mm	17,78mm	19,05mm	20,63mm	22,22mm	23,81mm	25,40mm	26,98mm	28,57mm	31,75mm	34,92mm	38,10mm	41,27mm	44,45mm	46,83mm	50,80mm

VEÍCULO		DESCRIÇÃO	ANOS	OBSERVAÇÃO	REF.	IMAGEM
<b>VOLKSWAGEN</b>						
SPACE CROSS		CILINDRO MESTRE DUPL0 20,63mm	2012/...	S/ABS	C-2160	
SPACE CROSS	<-	REPARO DE VEDAÇÃO DA PINÇA 54,00mm	2012/...		C-1587	
SPACE CROSS	->	CILINDRO DE RODA 19,05mm	2012/...		C-3440	
SPACE CROSS	->	REPARO DO CILINDRO DE RODA 19,05mm	2012/...		C-1447	
SPACE CROSS	->	GAXETA DO CILINDRO DE RODA 19,05mm	2012/...		GA-0307	
SPACE CROSS	->	TAPA PÓ DO CILINDRO DE RODA	2012/...		TA-0343	
TL		CILINDRO MESTRE SIMPLES 19,05mm	1969/1976		C-2005	
TL		REPARO DO CILINDRO MESTRE SIMPLES 19,05mm	1969/1976		C-1061	
TL		VEDANTE DO CILINDRO MESTRE	1969/1976		VE-0201	
TL	<-	REPARO DE VEDAÇÃO DA PINÇA 40,00mm	1969/1976		C-1498	
TL	->	CILINDRO DE RODA 22,22mm	1969/1976		C-3357	
TL	->	REPARO DO CILINDRO DE RODA 19,05mm	1969/1972	P/ CILINDRO 3/4"	C-1473	
TL	->	REPARO DO CILINDRO DE RODA 22,22mm	1969/1976		C-1496	
TL	->	COPO DO CILINDRO DE RODA 19,05mm	1969/1972	P/ CILINDRO 3/4"	CO-1312	
TL	->	COPO DO CILINDRO DE RODA 22,22mm	1969/1976		CO-1315	
TL	->	TAPA PÓ DO CILINDRO DE RODA	1969/1972	P/ CILINDRO 3/4"	TA-0329	
TL	->	TAPA PÓ DO CILINDRO DE RODA	1969/1976		TA-0336	
UP	->	CILINDRO DE RODA 17,46mm	2014/...		C-3537	
VAN		CILINDRO AUXILIAR DE EMBREAGEM 19,05mm	2001/2002		C-2656	
VAN		SERVO FREIO 230mm	1999/2002		C-5643	
VAN		CILINDRO MESTRE DUPL0 22,22mm	1999/2002		C-2074	
VAN		REPARO DO CILINDRO MESTRE DUPL0 22,22mm	1999/2002	C/CIL. ATE	C-1158	
VAN		REPARO DO CILINDRO MESTRE DUPL0 22,22mm	1999/2002	C/CIL. BENDIX	C-1163	
VAN		VEDANTE DO CILINDRO MESTRE	1999/2002		VE-0204	
VAN	<-	REPARO DE VEDAÇÃO DA PINÇA 54,00mm	1999/2002		C-1558	

Tabela de Conversão	Polegadas	9/16"	5/8"	11/16"	7/10"	3/4"	13/16"	7/8"	15/16"	1"	1 1/16"	1 1/8"	1 1/4"	1 3/8"	1 1/2"	1 5/8"	1 3/4"	1 27/32"	2"
	Milímetros	14,28mm	15,87mm	17,46mm	17,78mm	19,05mm	20,63mm	22,22mm	23,81mm	25,40mm	26,98mm	28,57mm	31,75mm	34,92mm	38,10mm	41,27mm	44,45mm	46,83mm	50,80mm

VEÍCULO		DESCRIÇÃO	ANOS	OBSERVAÇÃO	REF.	IMAGEM
<b>VOLKSWAGEN</b>						
VAN	->	CILINDRO DE RODA 20,63mm	1999/2002		C-3480	
VAN	->	REPARO DO CILINDRO DE RODA 20,63mm	1999/2002		C-1593	
VAN	->	GAXETA DO CILINDRO DE RODA 20,63mm	1999/2002		GA-0217	
VAN	->	TAPA PÓ DO CILINDRO DE RODA	1999/2002		TA-0343	
VARIANT		CILINDRO MESTRE SIMPLES 19,05mm	1970/1976		C-2005	
VARIANT		CILINDRO MESTRE DUPLA 19,05mm	1977/1977		C-2007	
VARIANT		REPARO DO CILINDRO MESTRE SIMPLES 19,05mm	1970/1976		C-1061	
VARIANT		REPARO DO CILINDRO MESTRE DUPLA 19,05mm	1977/1977		C-1060	
VARIANT		VEDANTE DO CILINDRO MESTRE	1970/1977		VE-0201	
VARIANT	<-	REPARO DE VEDAÇÃO DA PINÇA 40,00mm	1970/1977		C-1498	
VARIANT	->	CILINDRO DE RODA 22,22mm	1970/1977		C-3357	
VARIANT	->	REPARO DO CILINDRO DE RODA 19,05mm	1970/1972	P/ CILINDRO 3/4"	C-1473	
VARIANT	->	REPARO DO CILINDRO DE RODA 22,22mm	1970/1977		C-1496	
VARIANT	->	COPO DO CILINDRO DE RODA 19,05mm	1970/1972	P/ CILINDRO 3/4"	CO-1312	
VARIANT	->	COPO DO CILINDRO DE RODA 22,22mm	1970/1977		CO-1315	
VARIANT	->	TAPA PÓ DO CILINDRO DE RODA	1970/1972	P/ CILINDRO 3/4"	TA-0329	
VARIANT	->	TAPA PÓ DO CILINDRO DE RODA	1970/1977		TA-0336	
VARIANT II		REPARO DO CILINDRO MESTRE DUPLA 19,05mm	1978/1980		C-1060	
VARIANT II		VEDANTE DO CILINDRO MESTRE	1978/1980		VE-0201	
VARIANT II	<-	REPARO DE VEDAÇÃO DA PINÇA 44,00mm	1978/1980		C-1506	
VARIANT II	->	CILINDRO DE RODA 22,22mm	1978/1980		C-3357	
VARIANT II	->	REPARO DO CILINDRO DE RODA 22,22mm	1978/1980		C-1496	
VARIANT II	->	COPO DO CILINDRO DE RODA 22,22mm	1978/1980		CO-1315	
VARIANT II	->	TAPA PÓ DO CILINDRO DE RODA	1978/1980		TA-0336	
VOYAGE (G1)		SERVO FREIO 200mm	1982/1996		C-5600	
VOYAGE (G1)		VÁLVULA DE RETENÇÃO DE VÁCUO BRANCA	1982/1996	P/ SERVO VARGA SM180/SM200	C-1750	
VOYAGE (G1)		VÁLVULA DE RETENÇÃO DE VÁCUO	1982/1996		C-1753	
VOYAGE (G1)		CILINDRO MESTRE DUPLA 20,63mm	1982/1984		C-2009	
VOYAGE (G1)		CILINDRO MESTRE DUPLA 20,63mm	1985/1996		C-2000	
VOYAGE (G1)		REPARO DO CILINDRO MESTRE DUPLA 20,63mm	1982/1996		C-1027	
VOYAGE (G1)		REPARO DO CILINDRO MESTRE DUPLA 20,63mm	1988/1996	P/ CILINDRO ATE	C-1116	
VOYAGE (G1)		RESERVATÓRIO C/ TAMPA	1982/1984		C-0108	
VOYAGE (G1)		RESERVATÓRIO C/ TAMPA E AVISO DE NÍVEL	1985/1996		C-0102	
VOYAGE (G1)		VEDANTE DO CILINDRO MESTRE	1982/1996		VE-0201	

Tabela de Conversão	Polegadas	9/16"	5/8"	11/16"	7/10"	3/4"	13/16"	7/8"	15/16"	1"	1 1/16"	1 1/8"	1 1/4"	1 3/8"	1 1/2"	1 5/8"	1 3/4"	1 27/32"	2"
	Milímetros	14,28mm	15,87mm	17,46mm	17,78mm	19,05mm	20,63mm	22,22mm	23,81mm	25,40mm	26,98mm	28,57mm	31,75mm	34,92mm	38,10mm	41,27mm	44,45mm	46,83mm	50,80mm









VEÍCULO		DESCRIÇÃO	ANOS	OBSERVAÇÃO	REF.	IMAGEM
<b>VOLKSWAGEN</b>						
VOYAGE (G1)	<-	REPARO DE VEDAÇÃO DA PINÇA 44,00mm	1982/1996	MOTOR 1.5/1.6	C-1493	
VOYAGE (G1)	<-	REPARO DE VEDAÇÃO DA PINÇA 48,00mm	1987/1994	MOTOR 1.8	C-1443	
VOYAGE (G1)	->	CILINDRO DE RODA 14,28mm	1982/1996		C-3350	
VOYAGE (G1)	->	REPARO DO CILINDRO DE RODA 14,28mm	1982/1996		C-1494	
VOYAGE (G1)	->	GAXETA DO CILINDRO DE RODA 14,28mm	1982/1996		GA-0311	
VOYAGE (G1)	->	TAPA-PÓ DO CILINDRO DE RODA	1982/1996		TA-0338	
VOYAGE (G5)		CILINDRO MESTRE DE EMBREAGEM 15,87mm	2009/...		C-2657	
VOYAGE (G5)		CILINDRO AUXILIAR DE EMBREAGEM 19,05mm	2009/...		C-2651	
VOYAGE (G5)		SERVO FREIO 230mm	2009/...	SIST. ATE S/ABS	C-5669	
VOYAGE (G5)		CILINDRO MESTRE DUPLO 20,63mm	2009/2013	SIST. ATE S/ABS	C-2173	
VOYAGE (G5)	->	CILINDRO DE RODA 15,87mm	2009/...	1.0 E 1.6 S/ABS	C-3527	
VOYAGE (G5)	->	REPARO DO CILINDRO DE RODA 17,46mm	2009/...		C-1446	
VOYAGE (G5)	->	GAXETA DO CILINDRO DE RODA 17,46mm	2009/...		GA-0309	
VOYAGE (G5)	->	TAPA-PÓ DO CILINDRO DE RODA	2009/...		TA-0338	
<b>VOLKSWAGEN - CAMINHÕES</b>						
7-80		CILINDRO MESTRE DE EMBREAGEM 19,05mm	1982/1986		C-2608	
7-80		CILINDRO AUXILIAR DE EMBREAGEM 22,22mm	1982/1986		C-2612	
7-80		REPARO DO CIL. MESTRE DE EMBREAGEM 19,05mm	1982/1986		C-1612	
7-80		REPARO DO CIL. AUXILIAR DE EMBREAGEM 22,22mm	1982/1986		C-1613	
7-80		REPARO DO HYDROVAC 10"	1982/1986		C-1201	
7-80		REPARO PARCIAL DO HYDROVAC 10"	1982/1986		C-1202	
7-80		DIAFRAGMA DO HYDROVAC 10"	1982/1986		DI-0500	
7-80		REPARO DO CILINDRO MESTRE SIMPLES 38,10mm	1982/1986		C-1015	

BUSCA POR VEÍCULOS

Tabela de Conversão	Polegadas	9/16"	5/8"	11/16"	7/10"	3/4"	13/16"	7/8"	15/16"	1"	1 1/16"	1 1/8"	1 1/4"	1 3/8"	1 1/2"	1 5/8"	1 3/4"	1 27/32"	2"
	Milímetros	14,28mm	15,87mm	17,46mm	17,78mm	19,05mm	20,63mm	22,22mm	23,81mm	25,40mm	26,98mm	28,57mm	31,75mm	34,92mm	38,10mm	41,27mm	44,45mm	46,83mm	50,80mm

VEÍCULO		DESCRIÇÃO	ANOS	OBSERVAÇÃO	REF.	IMAGEM
<b>VOLKSWAGEN - CAMINHÕES</b>						
7-80	<	CILINDRO DE RODA 38,10mm	1982/1986		C-3333	
7-80	<	REPARO DO CILINDRO DE RODA 38,10mm	1982/1986		C-1433	
7-80	<	GAXETA DO CILINDRO DE RODA 38,10mm	1982/1986		GA-0302	
7-80	<	TAPA-PÓ DO CILINDRO DE RODA	1982/1986		TA-0327	
7-80	>	CILINDRO DE RODA 38,10mm	1982/1986		C-3333	
7-80	>	REPARO DO CILINDRO DE RODA 38,10mm	1982/1986		C-1433	
7-80	>	GAXETA DO CILINDRO DE RODA 38,10mm	1982/1986		GA-0302	
7-80	>	TAPA-PÓ DO CILINDRO DE RODA	1982/1986		TA-0327	
7-90		CILINDRO MESTRE DE EMBREAGEM 19,05mm	1982/1986		C-2608	
7-90		CILINDRO AUXILIAR DE EMBREAGEM 22,22mm	1982/1986		C-2612	
7-90		REPARO DO CIL. MESTRE DE EMBREAGEM 19,05mm	1982/1986		C-1612	
7-90		REPARO DO CIL. AUXILIAR DE EMBREAGEM 22,22mm	1982/1986		C-1613	
7-90		REPARO DO HYDROVAC 10"	1982/1986		C-1201	
7-90		REPARO PARCIAL DO HYDROVAC 10"	1982/1986		C-1202	
7-90		DIAPHRAGMA DO HYDROVAC 10"	1982/1986		DI-0500	
7-90		CILINDRO MESTRE SIMPLES 31,75mm	1982/1986		C-2076	
7-90		REPARO DO CILINDRO MESTRE SIMPLES 31,75mm	1982/1986		C-1023	
7-90	<	CILINDRO DE RODA 38,10mm	1982/1986		C-3333	
7-90	<	REPARO DO CILINDRO DE RODA 38,10mm	1982/1986		C-1433	
7-90	<	GAXETA DO CILINDRO DE RODA 38,10mm	1982/1986		GA-0302	
7-90	<	TAPA-PÓ DO CILINDRO DE RODA	1982/1986		TA-0327	
7-90	>	CILINDRO DE RODA 38,10mm	1982/1986		C-3333	
7-90	>	REPARO DO CILINDRO DE RODA 38,10mm	1982/1986		C-1433	
7-90	>	GAXETA DO CILINDRO DE RODA 38,10mm	1982/1986		GA-0302	
7-90	>	TAPA-PÓ DO CILINDRO DE RODA	1982/1986		TA-0327	

Tabela de Conversão	Polegadas	9/16"	5/8"	11/16"	7/10"	3/4"	13/16"	7/8"	15/16"	1"	1 1/16"	1 1/8"	1 1/4"	1 3/8"	1 1/2"	1 5/8"	1 3/4"	1 27/32"	2"
	Milímetros	14,28mm	15,87mm	17,46mm	17,78mm	19,05mm	20,63mm	22,22mm	23,81mm	25,40mm	26,98mm	28,57mm	31,75mm	34,92mm	38,10mm	41,27mm	44,45mm	46,83mm	50,80mm

VEÍCULO		DESCRIÇÃO	ANOS	OBSERVAÇÃO	REF.	IMAGEM
<b>VOLKSWAGEN - CAMINHÕES</b>						
7-90		CILINDRO MESTRE DE EMBREAGEM 19,05mm	1987/1994		C-2608	
7-90		CILINDRO AUXILIAR DE EMBREAGEM 22,22mm	1987/1994		C-2612	
7-90		REPARO DO CIL. MESTRE DE EMBREAGEM 19,05mm	1987/1994		C-1612	
7-90		REPARO DO CIL. AUXILIAR DE EMBREAGEM 22,22mm	1987/1994		C-1613	
7-90		REPARO DO HYDROVAC 10"	1987/1994		C-1201	
7-90		REPARO PARCIAL DO HYDROVAC 10"	1987/1994		C-1202	
7-90		DIAFRAGMA DO HYDROVAC 10"	1987/1994		DI-0500	
7-90		CILINDRO MESTRE SIMPLES 31,75mm	1987/1994		C-2076	
7-90		REPARO DO CILINDRO MESTRE SIMPLES 31,75mm	1987/1994		C-1023	
7-90	<	CILINDRO DE RODA 38,10mm	1987/1994		C-3333	
7-90	<	REPARO DO CILINDRO DE RODA 38,10mm	1987/1994		C-1433	
7-90	<	GAXETA DO CILINDRO DE RODA 38,10mm	1987/1994		GA-0302	
7-90	<	TAPA-PÓ DO CILINDRO DE RODA	1987/1994		TA-0327	
7-90	>	CILINDRO DE RODA 38,10mm	1987/1994		C-3333	
7-90	>	REPARO DO CILINDRO DE RODA 38,10mm	1987/1994		C-1433	
7-90	>	GAXETA DO CILINDRO DE RODA 38,10mm	1987/1994		GA-0302	
7-90	>	TAPA-PÓ DO CILINDRO DE RODA	1987/1994		TA-0327	
7-100		CILINDRO MESTRE DE EMBREAGEM 22,22mm	1994/1999		C-2605	
7-100		CILINDRO AUXILIAR DE EMBREAGEM 22,22mm	1994/2001		C-2613	
7-100		REPARO DO CIL. MESTRE DE EMBREAGEM 22,22mm	1994/2001		C-1631	
7-100		REPARO DO CIL. AUXILIAR DE EMBREAGEM 22,22mm	1994/2001		C-1630	
7-110		CILINDRO AUXILIAR DE EMBREAGEM 22,22mm	2002/2005		C-2613	
7-110		REPARO DO CIL. AUXILIAR DE EMBREAGEM 22,22mm	2002/2005		C-1630	

BUSCA POR VEÍCULOS

Tabela de Conversão	Polegadas	9/16"	5/8"	11/16"	7/10"	3/4"	13/16"	7/8"	15/16"	1"	1 1/16"	1 1/8"	1 1/4"	1 3/8"	1 1/2"	1 5/8"	1 3/4"	1 27/32"	2"
	Milímetros	14,28mm	15,87mm	17,46mm	17,78mm	19,05mm	20,63mm	22,22mm	23,81mm	25,40mm	26,98mm	28,57mm	31,75mm	34,92mm	38,10mm	41,27mm	44,45mm	46,83mm	50,80mm



VEÍCULO		DESCRIÇÃO	ANOS	OBSERVAÇÃO	REF.	IMAGEM
<b>VOLKSWAGEN - CAMINHÕES</b>						
7-110 S		CILINDRO MESTRE DE EMBREAGEM 19,05mm	1988/1994		C-2608	
7-110 S		CILINDRO AUXILIAR DE EMBREAGEM 22,22mm	1988/1994		C-2612	
7-110 S		REPARO DO CIL. MESTRE DE EMBREAGEM 19,05mm	1988/1994		C-1612	
7-110 S		REPARO DO CIL. AUXILIAR DE EMBREAGEM 22,22mm	1988/1994		C-1613	
7-110 S		REPARO DO HYDROVAC 10"	1988/1994		C-1201	
7-110 S		REPARO PARCIAL DO HYDROVAC 10"	1988/1994		C-1202	
7-110 S		DIAFRAGMA DO HYDROVAC 10"	1988/1994		DI-0500	
7-110 S		CILINDRO MESTRE SIMPLES 31,75mm	1988/1994		C-2076	
7-110 S		REPARO DO CILINDRO MESTRE SIMPLES 31,75mm	1988/1994		C-1023	
7-110 S	<-	CILINDRO DE RODA 38,10mm	1988/1994		C-3333	
7-110 S	<-	REPARO DO CILINDRO DE RODA 38,10mm	1988/1994		C-1433	
7-110 S	<-	GAXETA DO CILINDRO DE RODA 38,10mm	1988/1994		GA-0302	
7-110 S	<-	TAPA-PÓ DO CILINDRO DE RODA	1988/1994		TA-0327	
7-110 S	->	CILINDRO DE RODA 38,10mm	1988/1994		C-3333	
7-110 S	->	REPARO DO CILINDRO DE RODA 38,10mm	1988/1994		C-1433	
7-110 S	->	GAXETA DO CILINDRO DE RODA 38,10mm	1988/1994		GA-0302	
7-110 S	->	TAPA-PÓ DO CILINDRO DE RODA	1988/1994		TA-0327	
8-100		CILINDRO MESTRE DE EMBREAGEM 22,22mm	1997/2000		C-2605	
8-100		CILINDRO AUXILIAR DE EMBREAGEM 22,22mm	1997/2000		C-2613	
8-100		REPARO DO CIL. MESTRE DE EMBREAGEM 22,22mm	1997/2000		C-1631	
8-100		REPARO DO CIL. AUXILIAR DE EMBREAGEM 22,22mm	1997/2000		C-1630	
8-120		CILINDRO AUXILIAR DE EMBREAGEM 22,22mm	2000/...		C-2613	
8-120		REPARO DO CIL. MESTRE DE EMBREAGEM 22,22mm	2000/...		C-1631	
8-120		REPARO DO CIL. AUXILIAR DE EMBREAGEM 22,22mm	2000/...		C-1630	

Tabela de Conversão	Polegadas	9/16"	5/8"	11/16"	7/10"	3/4"	13/16"	7/8"	15/16"	1"	1 1/16"	1 1/8"	1 1/4"	1 3/8"	1 1/2"	1 5/8"	1 3/4"	1 27/32"	2"
	Milímetros	14,28mm	15,87mm	17,46mm	17,78mm	19,05mm	20,63mm	22,22mm	23,81mm	25,40mm	26,98mm	28,57mm	31,75mm	34,92mm	38,10mm	41,27mm	44,45mm	46,83mm	50,80mm

VEÍCULO		DESCRIÇÃO	ANOS	OBSERVAÇÃO	REF.	IMAGEM
<b>VOLKSWAGEN - CAMINHÕES</b>						
8-140 CE/CO		CILINDRO MESTRE DE EMBREAGEM 22,22mm	1994/1999		C-2605	
8-140 CE/CO		CILINDRO AUXILIAR DE EMBREAGEM 22,22mm	1994/2000		C-2613	
8-140 CE/CO		REPARO DO CIL. MESTRE DE EMBREAGEM 22,22mm	1994/2000		C-1631	
8-140 CE/CO		REPARO DO CIL. AUXILIAR DE EMBREAGEM 22,22mm	1994/2000		C-1630	
8-150		CILINDRO AUXILIAR DE EMBREAGEM 22,22mm	2000/...		C-2613	
8-150		REPARO DO CIL. MESTRE DE EMBREAGEM 22,22mm	2000/...		C-1631	
8-150		REPARO DO CIL. AUXILIAR DE EMBREAGEM 22,22mm	2000/...		C-1630	
9-150 OD		CILINDRO AUXILIAR DE EMBREAGEM 22,22mm	2001/...		C-2613	
9-150 OD		REPARO DO CIL. MESTRE DE EMBREAGEM 22,22mm	2001/...		C-1631	
9-150 OD		REPARO DO CIL. AUXILIAR DE EMBREAGEM 22,22mm	2001/...		C-1630	
11-130		CILINDRO MESTRE DE EMBREAGEM 19,05mm	1982/1985		C-2608	
11-130		CILINDRO AUXILIAR DE EMBREAGEM 22,22mm	1982/1985		C-2612	
11-130		REPARO DO CIL. MESTRE DE EMBREAGEM 19,05mm	1982/1985		C-1612	
11-130		REPARO DO CIL. AUXILIAR DE EMBREAGEM 22,22mm	1982/1985		C-1613	
11-130		REPARO DO HYDROVAC 10"	1982/1985		C-1201	
11-130		REPARO PARCIAL DO HYDROVAC 10"	1982/1985		C-1202	
11-130		DIAFRAGMA DO HYDROVAC 10"	1982/1985		DI-0500	
11-130		REPARO DO CILINDRO MESTRE SIMPLES 38,10mm	1982/1985		C-1015	
11-130	<	CILINDRO DE RODA ESQUERDA SUPERIOR 34,92mm	1982/1985		C-3320	
11-130	<<	CILINDRO DE RODA DIREITA SUPERIOR 34,92mm	1982/1985		C-3321	
11-130	<<	CILINDRO DE RODA ESQUERDA INFERIOR 34,92mm	1982/1985		C-3322	

BUSCA POR VEÍCULOS

Tabela de Conversão	Polegadas	9/16"	5/8"	11/16"	7/10"	3/4"	13/16"	7/8"	15/16"	1"	1 1/16"	1 1/8"	1 1/4"	1 3/8"	1 1/2"	1 5/8"	1 3/4"	1 27/32"	2"
	Milímetros	14,28mm	15,87mm	17,46mm	17,78mm	19,05mm	20,63mm	22,22mm	23,81mm	25,40mm	26,98mm	28,57mm	31,75mm	34,92mm	38,10mm	41,27mm	44,45mm	46,83mm	50,80mm





















VEÍCULO		DESCRIÇÃO	ANOS	OBSERVAÇÃO	REF.	IMAGEM
<b>VOLKSWAGEN - CAMINHÕES</b>						
11-130	<-	CILINDRO DE RODA DIREITA INFERIOR 34,92mm	1982/1985		C-3323	
11-130	<-	REPARO DO CILINDRO DE RODA 34,92mm	1982/1985		C-1401	
11-130	<-	GAXETA DO CILINDRO DE RODA 34,92mm	1982/1985		GA-0312	
11-130	<-	TAPA-PÓ DO CILINDRO DE RODA	1982/1985		TA-0323	
11-130	->	REPARO DO CILINDRO DE RODA 38,10mm	1982/1985		C-1432	
11-130	->	GAXETA DO CILINDRO DE RODA 38,10mm	1982/1985		GA-0302	
11-130	->	TAPA-PÓ DO CILINDRO DE RODA	1982/1985		TA-0323	
11-140		CILINDRO MESTRE DE EMBREAGEM 19,05mm	1982/1993		C-2608	
11-140		CILINDRO AUXILIAR DE EMBREAGEM 22,22mm	1982/1993		C-2612	
11-140		REPARO DO CIL. MESTRE DE EMBREAGEM 19,05mm	1982/1993		C-1612	
11-140		REPARO DO CIL. AUXILIAR DE EMBREAGEM 22,22mm	1982/1993		C-1613	
11-160		CILINDRO MESTRE DE EMBREAGEM 19,05mm	1986/1993		C-2608	
11-160		CILINDRO AUXILIAR DE EMBREAGEM 22,22mm	1986/1993		C-2612	
11-160		REPARO DO CIL. MESTRE DE EMBREAGEM 19,05mm	1986/1993		C-1612	
11-160		REPARO DO CIL. AUXILIAR DE EMBREAGEM 22,22mm	1986/1993		C-1613	
12-140		CILINDRO MESTRE DE EMBREAGEM 19,05mm	1982/2000		C-2608	
12-140		CILINDRO AUXILIAR DE EMBREAGEM 22,22mm	1982/2000		C-2612	
12-140		REPARO DO CIL. MESTRE DE EMBREAGEM 19,05mm	1982/2000		C-1612	
12-140		REPARO DO CIL. AUXILIAR DE EMBREAGEM 22,22mm	1982/2000		C-1613	
12-140H		CILINDRO MESTRE DE EMBREAGEM 22,22mm	1989/1998		C-2605	
12-140H		CILINDRO AUXILIAR DE EMBREAGEM 22,22mm	1994/1998		C-2613	

Tabela de Conversão	Polegadas	9/16"	5/8"	11/16"	7/10"	3/4"	13/16"	7/8"	15/16"	1"	1 1/16"	1 1/8"	1 1/4"	1 3/8"	1 1/2"	1 5/8"	1 3/4"	1 27/32"	2"
	Milímetros	14,28mm	15,87mm	17,46mm	17,78mm	19,05mm	20,63mm	22,22mm	23,81mm	25,40mm	26,98mm	28,57mm	31,75mm	34,92mm	38,10mm	41,27mm	44,45mm	46,83mm	50,80mm

VEÍCULO		DESCRIÇÃO	ANOS	OBSERVAÇÃO	REF.	IMAGEM
<b>VOLKSWAGEN - CAMINHÕES</b>						
12-140H		REPARO DO CIL. MESTRE DE EMBREAGEM 22,22mm	1989/1998		C-1631	
12-140H		REPARO DO CIL. AUXILIAR DE EMBREAGEM 22,22mm	1994/1998		C-1630	
13-130		CILINDRO MESTRE DE EMBREAGEM 19,05mm	1981/1986		C-2608	
13-130		CILINDRO AUXILIAR DE EMBREAGEM 22,22mm	1981/1986		C-2612	
13-130		REPARO DO CIL. MESTRE DE EMBREAGEM 19,05mm	1981/1986		C-1612	
13-130		REPARO DO CIL. AUXILIAR DE EMBREAGEM 22,22mm	1981/1986		C-1613	
13-150		REPARO DO CIL. MESTRE DE EMBREAGEM 22,22mm	2000/...		C-1631	
13-170		REPARO DO CIL. MESTRE DE EMBREAGEM 22,22mm	2000/...		C-1631	
13-180		REPARO DO CIL. MESTRE DE EMBREAGEM 22,22mm	2000/...		C-1631	
13-210		CILINDRO AUXILIAR DE EMBREAGEM 22,22mm	1987/1991		C-2616	
13-210		REPARO DO CIL. AUXILIAR DE EMBREAGEM 22,22mm	1987/1991		C-1632	
14-140		CILINDRO MESTRE DE EMBREAGEM 19,05mm	1982/1991		C-2608	
14-140		CILINDRO AUXILIAR DE EMBREAGEM 22,22mm	1982/1991		C-2612	
14-140		REPARO DO CIL. MESTRE DE EMBREAGEM 19,05mm	1982/1991		C-1612	
14-140		REPARO DO CIL. AUXILIAR DE EMBREAGEM 22,22mm	1982/1991		C-1613	
14-150		CILINDRO MESTRE DE EMBREAGEM 22,22mm	1991/2000		C-2605	
14-150		CILINDRO AUXILIAR DE EMBREAGEM 22,22mm	1991/2000	C/ CÂMBIO SINCRONIZADO	C-2613	
14-150		REPARO DO CIL. MESTRE DE EMBREAGEM 22,22mm	1991/2000		C-1631	
14-150		REPARO DO CIL. AUXILIAR DE EMBREAGEM 22,22mm	1991/2000		C-1630	
14-200		CILINDRO MESTRE DE EMBREAGEM 22,22mm	1991/1994		C-2605	
14-200		CILINDRO AUXILIAR DE EMBREAGEM 22,22mm	1991/1994		C-2613	

BUSCA POR VEÍCULOS

Tabela de Conversão	Polegadas	9/16"	5/8"	11/16"	7/10"	3/4"	13/16"	7/8"	15/16"	1"	1 1/16"	1 1/8"	1 1/4"	1 3/8"	1 1/2"	1 5/8"	1 3/4"	1 27/32"	2"
	Milímetros	14,28mm	15,87mm	17,46mm	17,78mm	19,05mm	20,63mm	22,22mm	23,81mm	25,40mm	26,98mm	28,57mm	31,75mm	34,92mm	38,10mm	41,27mm	44,45mm	46,83mm	50,80mm











VEÍCULO		DESCRIÇÃO	ANOS	OBSERVAÇÃO	REF.	IMAGEM
<b>VOLKSWAGEN - CAMINHÕES</b>						
14-200		REPARO DO CIL. MESTRE DE EMBREAGEM 22,22mm	1991/1994		C-1631	
14-200		REPARO DO CIL. AUXILIAR DE EMBREAGEM 22,22mm	1991/1994		C-1630	
14-210		CILINDRO MESTRE DE EMBREAGEM 22,22mm	1987/1991		C-2605	
14-210		CILINDRO AUXILIAR DE EMBREAGEM 22,22mm	1987/1991		C-2616	
14-210		REPARO DO CIL. MESTRE DE EMBREAGEM 22,22mm	1987/1991		C-1631	
14-210		REPARO DO CIL. AUXILIAR DE EMBREAGEM 22,22mm	1987/1991		C-1632	
14-220		CILINDRO MESTRE DE EMBREAGEM 22,22mm	1992/2000		C-2605	
14-220		CILINDRO AUXILIAR DE EMBREAGEM 22,22mm	1992/2000		C-2613	
14-220		REPARO DO CIL. MESTRE DE EMBREAGEM 22,22mm	1992/2000		C-1631	
14-220		REPARO DO CIL. AUXILIAR DE EMBREAGEM 22,22mm	1992/2000		C-1630	
15-170		REPARO DO CIL. MESTRE DE EMBREAGEM 22,22mm	2000/2006		C-1631	
15-180		REPARO DO CIL. MESTRE DE EMBREAGEM 22,22mm	2000/...		C-1631	
16-170		CILINDRO MESTRE DE EMBREAGEM 22,22mm	1991/1999		C-2605	
16-170		CILINDRO AUXILIAR DE EMBREAGEM 22,22mm	1991/1999		C-2613	
16-170		REPARO DO CIL. MESTRE DE EMBREAGEM 22,22mm	1991/1999		C-1631	
16-170		REPARO DO CIL. AUXILIAR DE EMBREAGEM 22,22mm	1991/1999		C-1630	
16-210		CILINDRO MESTRE DE EMBREAGEM 22,22mm	1989/1991		C-2605	
16-210		CILINDRO AUXILIAR DE EMBREAGEM 22,22mm	1989/1991		C-2616	
16-210		REPARO DO CIL. MESTRE DE EMBREAGEM 22,22mm	1989/1991		C-1631	
16-210		REPARO DO CIL. AUXILIAR DE EMBREAGEM 22,22mm	1989/1991		C-1632	
16-220		CILINDRO MESTRE DE EMBREAGEM 22,22mm	1991/2000		C-2605	

Tabela de Conversão	Polegadas	9/16"	5/8"	11/16"	7/10"	3/4"	13/16"	7/8"	15/16"	1"	1 1/16"	1 1/8"	1 1/4"	1 3/8"	1 1/2"	1 5/8"	1 3/4"	1 27/32"	2"
	Milímetros	14,28mm	15,87mm	17,46mm	17,78mm	19,05mm	20,63mm	22,22mm	23,81mm	25,40mm	26,98mm	28,57mm	31,75mm	34,92mm	38,10mm	41,27mm	44,45mm	46,83mm	50,80mm

VEÍCULO		DESCRIÇÃO	ANOS	OBSERVAÇÃO	REF.	IMAGEM
<b>VOLKSWAGEN - CAMINHÕES</b>						
16-220		CILINDRO AUXILIAR DE EMBREAGEM 22,22mm	1991/2000		C-2613	
16-220		REPARO DO CIL. MESTRE DE EMBREAGEM 22,22mm	1991/2000		C-1631	
16-220		REPARO DO CIL. AUXILIAR DE EMBREAGEM 22,22mm	1991/2000		C-1630	
17-210		REPARO DO CIL. MESTRE DE EMBREAGEM 22,22mm	2000/2006		C-1631	
17-220		REPARO DO CIL. MESTRE DE EMBREAGEM 22,22mm	2000/...		C-1631	
17-300		REPARO DO CIL. MESTRE DE EMBREAGEM 22,22mm	2000/2002		C-1631	
17-310		REPARO DO CIL. MESTRE DE EMBREAGEM 22,22mm	2002/2006		C-1631	
17-330		REPARO DO CIL. MESTRE DE EMBREAGEM 22,22mm	2000/2000		C-1631	
22-160		CILINDRO MESTRE DE EMBREAGEM 19,05mm	1986/1989		C-2608	
22-160		CILINDRO AUXILIAR DE EMBREAGEM 22,22mm	1986/1989		C-2612	
22-160		REPARO DO CIL. MESTRE DE EMBREAGEM 19,05mm	1986/1989		C-1612	
22-160		REPARO DO CIL. AUXILIAR DE EMBREAGEM 22,22mm	1986/1989		C-1613	
24-220		CILINDRO MESTRE DE EMBREAGEM 22,22mm	1991/1999		C-2605	
24-220		CILINDRO AUXILIAR DE EMBREAGEM 22,22mm	1991/...		C-2613	
24-220		REPARO DO CIL. MESTRE DE EMBREAGEM 22,22mm	1991/...		C-1631	
24-220		REPARO DO CIL. AUXILIAR DE EMBREAGEM 22,22mm	1991/...		C-1630	
24-250		CILINDRO MESTRE DE EMBREAGEM 22,22mm	1992/1999		C-2605	
24-250		CILINDRO AUXILIAR DE EMBREAGEM 22,22mm	1992/...	S/ SERVO EMBREAGEM	C-2613	
24-250		REPARO DO CIL. MESTRE DE EMBREAGEM 22,22mm	1992/...		C-1631	
24-250		REPARO DO CIL. AUXILIAR DE EMBREAGEM 22,22mm	1992/...		C-1630	
26-300		REPARO DO CIL. MESTRE DE EMBREAGEM 22,22mm	2000/2001		C-1631	
26-310		REPARO DO CIL. MESTRE DE EMBREAGEM 22,22mm	2002/2005		C-1631	
35-300		CILINDRO MESTRE DE EMBREAGEM 22,22mm	1991/1999		C-2605	

BUSCA POR VEÍCULOS

Tabela de Conversão	Polegadas	9/16"	5/8"	11/16"	7/10"	3/4"	13/16"	7/8"	15/16"	1"	1 1/16"	1 1/8"	1 1/4"	1 3/8"	1 1/2"	1 5/8"	1 3/4"	1 27/32"	2"
	Milímetros	14,28mm	15,87mm	17,46mm	17,78mm	19,05mm	20,63mm	22,22mm	23,81mm	25,40mm	26,98mm	28,57mm	31,75mm	34,92mm	38,10mm	41,27mm	44,45mm	46,83mm	50,80mm

VEÍCULO		DESCRIÇÃO	ANOS	OBSERVAÇÃO	REF.	IMAGEM
<b>VOLKSWAGEN - CAMINHÕES</b>						
35-300		CILINDRO AUXILIAR DE EMBREAGEM 22,22mm	1991/1999		C-2613	
35-300		REPARO DO CIL. MESTRE DE EMBREAGEM 22,22mm	1991/1999		C-1631	
35-300		REPARO DO CIL. AUXILIAR DE EMBREAGEM 22,22mm	1991/1999		C-1630	
40-300		CILINDRO AUXILIAR DE EMBREAGEM 22,22mm	1999/2001		C-2613	
40-300		REPARO DO CIL. MESTRE DE EMBREAGEM 22,22mm	1999/2001		C-1631	
40-300		REPARO DO CIL. AUXILIAR DE EMBREAGEM 22,22mm	1999/2001		C-1630	
E-11	<-	COPO DO CILINDRO DE RODA 25,40mm	1981/1983		CO-1307	
E-11	<-	TAPA-PÓ DO CILINDRO DE RODA	1981/1983		TA-0314	
E-11	->	REPARO DO CILINDRO DE RODA 41,27mm	1981/1983	P/ CILINDRO BENDIX	C-1485	
E-11	->	REPARO DO CILINDRO DE RODA 41,27mm	1981/1983	P/ CILINDRO VARGA	C-1487	
E-11	->	COPO DO CILINDRO DE RODA 41,27mm	1981/1983	P/ CILINDRO VARGA	CO-1316	
E-11	->	GAXETA DO CILINDRO DE RODA 41,27mm	1981/1983	P/ CILINDRO BENDIX	GA-0300	
E-11	->	TAPA-PÓ DO CILINDRO DE RODA	1981/1983		TA-0323	
<b>VOLVO</b>						
440	<-	REPARO DE VEDAÇÃO DA PINÇA 54,00mm	1992/1993	SIST. GIRLING	C-1558	
440	<-	REPARO DE VEDAÇÃO DA PINÇA 54,00mm	1992/1993	SIST. ATE	C-1587	
440	<-	TAPA PÓ DO PINO DE GUIA	1992/1993	SIST. GIRLING	TA-0322	
460	<-	REPARO DE VEDAÇÃO DA PINÇA 54,00mm	1992/1996	SIST. GIRLING	C-1558	
460	<-	REPARO DE VEDAÇÃO DA PINÇA 54,00mm	1992/1996	SIST. ATE	C-1587	
460	<-	TAPA PÓ DO PINO DE GUIA	1992/1996	SIST. GIRLING	TA-0322	
850	<-	REPARO DE VEDAÇÃO DA PINÇA 57,00mm	1992/1997		C-1567	
C70	<-	REPARO DE VEDAÇÃO DA PINÇA 57,00mm	1998/2005		C-1567	
S40	->	REPARO DE VEDAÇÃO DA PINÇA 38,00mm	1996/2003	SIST. GIRLING	C-1549	
S40	->	REPARO DE VEDAÇÃO DA PINÇA 38,00mm	1996/2003	SIST. LUCAS	C-1551	
S40	->	TAPA PÓ DO PINO DE GUIA	1996/2003	SIST. GIRLING	TA-0322	
S70	<-	REPARO DE VEDAÇÃO DA PINÇA 57,00mm	1997/2000		C-1567	
V40	->	REPARO DE VEDAÇÃO DA PINÇA 38,00mm	1997/2004	SIST. GIRLING	C-1549	
V40	->	REPARO DE VEDAÇÃO DA PINÇA 38,00mm	1997/2004	SIST. LUCAS	C-1551	
V40	->	TAPA PÓ DO PINO DE GUIA	1997/2004	SIST. GIRLING	TA-0322	
V70	<-	REPARO DE VEDAÇÃO DA PINÇA 57,00mm	1997/2000		C-1567	
<b>VOLVO - CAMINHÕES</b>						
B-10 M		CILINDRO MESTRE DE EMBREAGEM 28,57mm	1986/...		C-2637	
B-10 M		REPARO DO CIL. MESTRE DE EMBREAGEM 28,57mm	1986/...		C-1638	
B-10 M		VEDANTE DO CILINDRO MESTRE	1986/...		VE-0202	
B-12		CILINDRO MESTRE DE EMBREAGEM 28,57mm	1992/...		C-2637	
B-12		REPARO DO CIL. MESTRE DE EMBREAGEM 28,57mm	1992/...		C-1638	
B-12		VEDANTE DO CILINDRO MESTRE	1992/...		VE-0202	
B-58		CILINDRO MESTRE DE EMBREAGEM 28,57mm	1979/...		C-2637	

Tabela de Conversão	Polegadas	9/16"	5/8"	11/16"	7/10"	3/4"	13/16"	7/8"	15/16"	1"	1 1/16"	1 1/8"	1 1/4"	1 3/8"	1 1/2"	1 5/8"	1 3/4"	1 27/32"	2"
	Milímetros	14,28mm	15,87mm	17,46mm	17,78mm	19,05mm	20,63mm	22,22mm	23,81mm	25,40mm	26,98mm	28,57mm	31,75mm	34,92mm	38,10mm	41,27mm	44,45mm	46,83mm	50,80mm



VEÍCULO		DESCRIÇÃO	ANOS	OBSERVAÇÃO	REF.	IMAGEM
<b>VOLVO - CAMINHÕES</b>						
B-58		REPARO DO CIL. MESTRE DE EMBREAGEM 28,57mm	1979/...		C-1638	
B-58		VEDANTE DO CILINDRO MESTRE	1979/...		VE-0202	
FH-12		CILINDRO MESTRE DE EMBREAGEM 28,57mm	1993/2006		C-2665	
FH-12		REPARO DO CIL. MESTRE DE EMBREAGEM 28,57mm	1993/2006		C-1638	
N/NL-10		CILINDRO MESTRE DE EMBREAGEM 28,57mm	1980/...		C-2637	
N/NL-10		REPARO DO CIL. MESTRE DE EMBREAGEM 28,57mm	1980/...		C-1638	
N/NL-10		VEDANTE DO CILINDRO MESTRE	1980/...		VE-0202	
N/NL-12		CILINDRO MESTRE DE EMBREAGEM 28,57mm	1981/...		C-2637	
N/NL-12		REPARO DO CIL. MESTRE DE EMBREAGEM 28,57mm	1981/...		C-1638	
N/NL-12		VEDANTE DO CILINDRO MESTRE	1981/...		VE-0202	
NH-12		CILINDRO MESTRE DE EMBREAGEM 28,57mm	1999/2006		C-2665	
NH-12		REPARO DO CIL. MESTRE DE EMBREAGEM 28,57mm	1999/2006		C-1638	

Tabela de Conversão	Polegadas	9/16"	5/8"	11/16"	7/10"	3/4"	13/16"	7/8"	15/16"	1"	1 1/16"	1 1/8"	1 1/4"	1 3/8"	1 1/2"	1 5/8"	1 3/4"	1 27/32"	2"
	Milímetros	14,28mm	15,87mm	17,46mm	17,78mm	19,05mm	20,63mm	22,22mm	23,81mm	25,40mm	26,98mm	28,57mm	31,75mm	34,92mm	38,10mm	41,27mm	44,45mm	46,83mm	50,80mm





# BUSCA POR PEÇAS

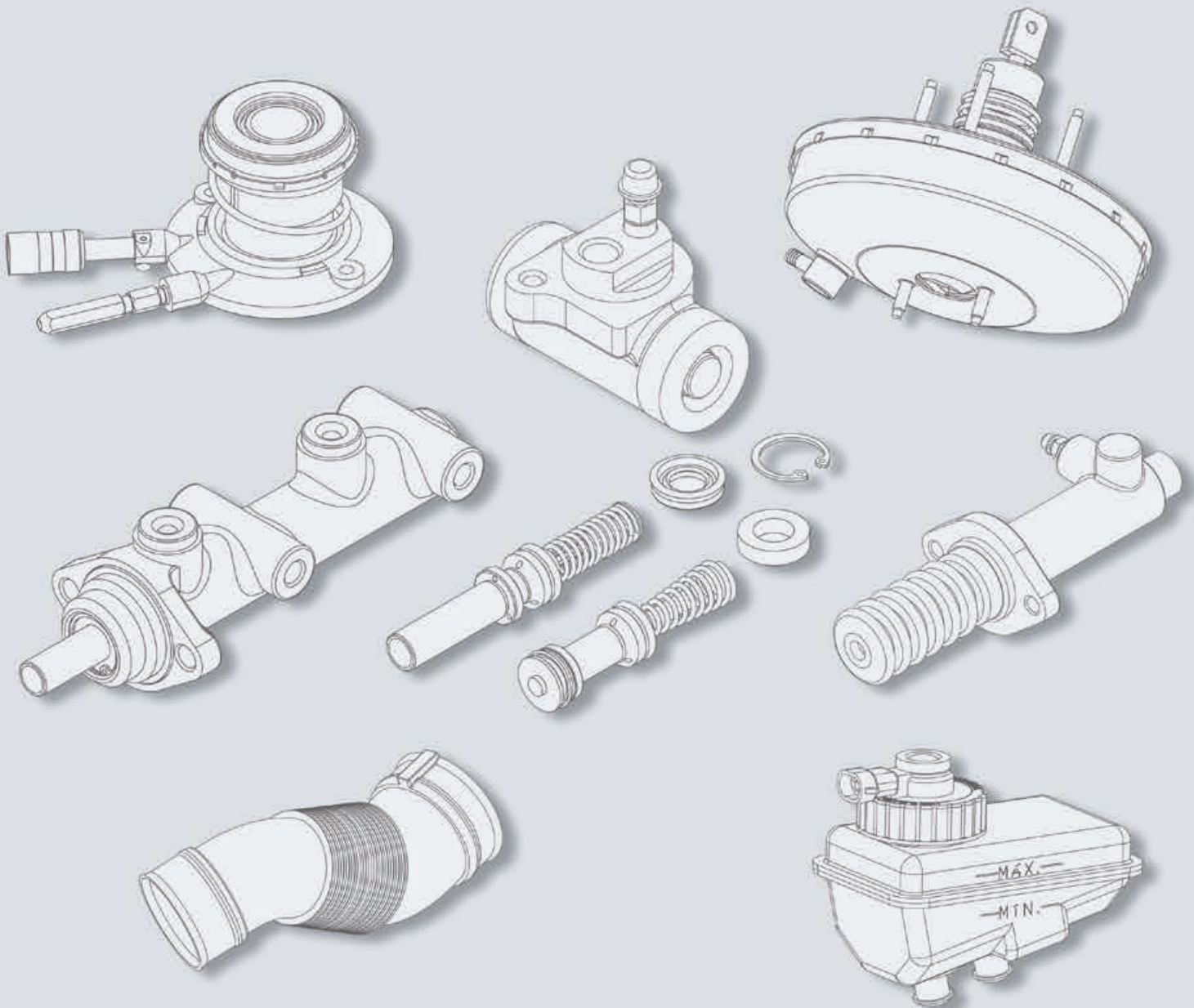



---

## RESERVATÓRIO DE LÍQUIDO DE FREIO

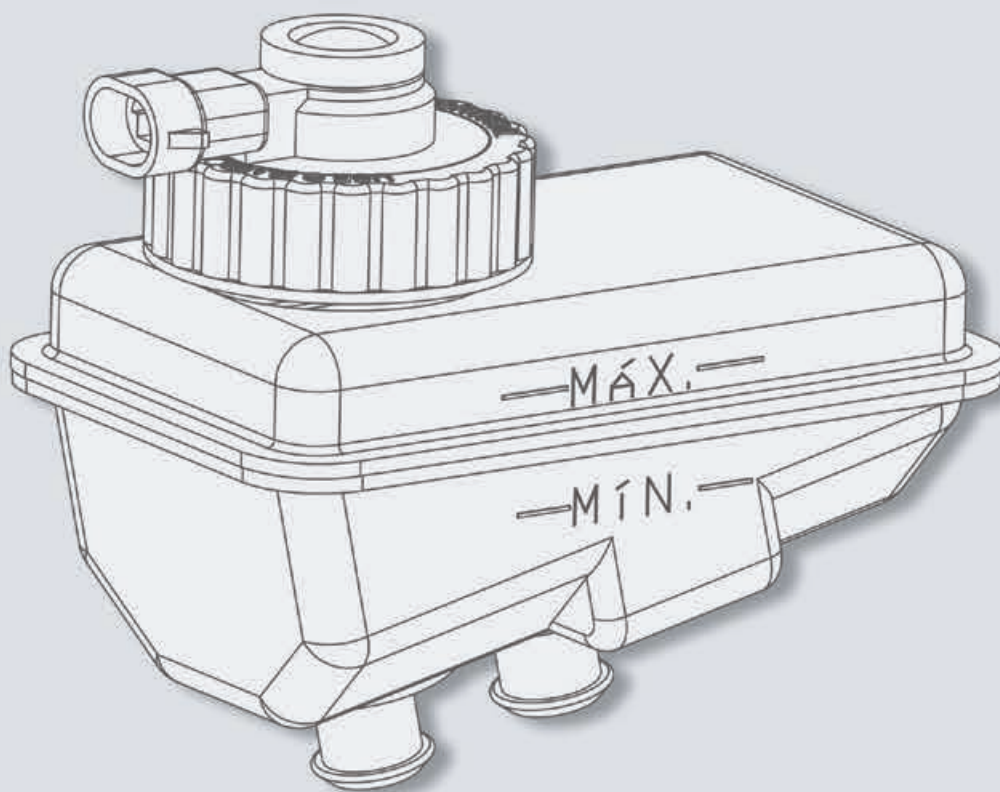



PEÇA	DESCRIÇÃO	MARCA	VEÍCULO		ANOS	SOMENTE PARA
C-0100	RESERVATÓRIO C/ TAMPA E AVISO DE NÍVEL	GM - CHEVROLET	CHEVETTE		1973/1986	
C-0100	RESERVATÓRIO C/ TAMPA E AVISO DE NÍVEL	GM - CHEVROLET	CHEVY		1983/1986	
C-0100	RESERVATÓRIO C/ TAMPA E AVISO DE NÍVEL	GM - CHEVROLET	MARAJÓ		1981/1986	
C-0101	RESERVATÓRIO C/ TAMPA E AVISO DE NÍVEL	GM - CHEVROLET	OMEGA		1993/1998	4 CIL. S/ABS SIST. VARGA
C-0101	RESERVATÓRIO C/ TAMPA E AVISO DE NÍVEL	GM - CHEVROLET	SUPREMA		1993/1997	4 CIL. S/ABS SIST. VARGA
C-0102	RESERVATÓRIO C/ TAMPA E AVISO DE NÍVEL	FIAT	147/SPAZIO		1983/1987	SIST. VARGA
C-0102	RESERVATÓRIO C/ TAMPA E AVISO DE NÍVEL	FIAT	FIORINO (mod. 147)		1983/1988	SIST. VARGA
C-0102	RESERVATÓRIO C/ TAMPA E AVISO DE NÍVEL	FIAT	OGGI		1983/1985	SIST. VARGA
C-0102	RESERVATÓRIO C/ TAMPA E AVISO DE NÍVEL	FIAT	PANORAMA		1983/1987	SIST. VARGA
C-0102	RESERVATÓRIO C/ TAMPA E AVISO DE NÍVEL	FORD	BELINA		1977/1977	
C-0102	RESERVATÓRIO C/ TAMPA E AVISO DE NÍVEL	FORD	BELINA II		1978/1991	
C-0102	RESERVATÓRIO C/ TAMPA E AVISO DE NÍVEL	FORD	CORCEL		1977/1977	
C-0102	RESERVATÓRIO C/ TAMPA E AVISO DE NÍVEL	FORD	CORCEL II		1978/1986	
C-0102	RESERVATÓRIO C/ TAMPA E AVISO DE NÍVEL	FORD	DEL REY		1981/1991	
C-0102	RESERVATÓRIO C/ TAMPA E AVISO DE NÍVEL	FORD	PAMPA		1982/1997	
C-0102	RESERVATÓRIO C/ TAMPA E AVISO DE NÍVEL	VOLKSWAGEN	GOL (G1)		1985/1996	
C-0102	RESERVATÓRIO C/ TAMPA E AVISO DE NÍVEL	VOLKSWAGEN	GOL (G2)		1995/2005	EXCETO 2.0 16V E ABS
C-0102	RESERVATÓRIO C/ TAMPA E AVISO DE NÍVEL	VOLKSWAGEN	GOL (G3)		2000/2005	EXCETO 1.0 TURBO, 2.0 16V E ABS
C-0102	RESERVATÓRIO C/ TAMPA E AVISO DE NÍVEL	VOLKSWAGEN	GOL (G4)		2006/...	
C-0102	RESERVATÓRIO C/ TAMPA E AVISO DE NÍVEL	VOLKSWAGEN	PARATI (G1)		1985/1996	
C-0102	RESERVATÓRIO C/ TAMPA E AVISO DE NÍVEL	VOLKSWAGEN	PARATI (G2, G3 e G4)		1996/2012	EXCETO 1.0 TURBO, 2.0 16V E ABS
C-0102	RESERVATÓRIO C/ TAMPA E AVISO DE NÍVEL	VOLKSWAGEN	PASSAT		1985/1989	
C-0102	RESERVATÓRIO C/ TAMPA E AVISO DE NÍVEL	VOLKSWAGEN	SAVEIRO (G1)		1985/1997	
C-0102	RESERVATÓRIO C/ TAMPA E AVISO DE NÍVEL	VOLKSWAGEN	SAVEIRO (G2, G3 e G4)		1998/2009	S/ABS
C-0102	RESERVATÓRIO C/ TAMPA E AVISO DE NÍVEL	VOLKSWAGEN	VOYAGE (G1)		1985/1996	
C-0103	RESERVATÓRIO C/ TAMPA E AVISO DE NÍVEL	GM - CHEVROLET	IPANEMA		1990/1998	SIST. VARGA S/ CHECK CONTROL
C-0103	RESERVATÓRIO C/ TAMPA E AVISO DE NÍVEL	GM - CHEVROLET	KADETT		1989/1998	SIST. VARGA S/ CHECK CONTROL
C-0103	RESERVATÓRIO C/ TAMPA E AVISO DE NÍVEL	GM - CHEVROLET	MONZA		1982/1996	SIST. VARGA S/ABS
C-0104	RESERVATÓRIO C/ TAMPA E AVISO DE NÍVEL	GM - CHEVROLET	CHEVETTE		1987/1994	SIST. ATE
C-0104	RESERVATÓRIO C/ TAMPA E AVISO DE NÍVEL	GM - CHEVROLET	CHEVY		1987/1995	SIST. ATE
C-0104	RESERVATÓRIO C/ TAMPA E AVISO DE NÍVEL	GM - CHEVROLET	MARAJÓ		1987/1989	SIST. ATE
C-0105	RESERVATÓRIO C/ TAMPA	AGRALE	1600 A/D RS/RD		1986/1987	
C-0105	RESERVATÓRIO C/ TAMPA	FORD	F-100		1982/1987	
C-0105	RESERVATÓRIO C/ TAMPA	FORD	F-1000		1979/1987	
C-0105	RESERVATÓRIO C/ TAMPA	FORD	F-2000		1980/1987	
C-0105	RESERVATÓRIO C/ TAMPA	GM - CHEVROLET	A-10		1985/1987	
C-0105	RESERVATÓRIO C/ TAMPA	GM - CHEVROLET	A-20		1985/1987	
C-0105	RESERVATÓRIO C/ TAMPA	GM - CHEVROLET	C-10/14/15/16		1973/1987	
C-0105	RESERVATÓRIO C/ TAMPA	GM - CHEVROLET	C-20		1985/1987	
C-0105	RESERVATÓRIO C/ TAMPA	GM - CHEVROLET	D-10		1979/1984	
C-0105	RESERVATÓRIO C/ TAMPA	GM - CHEVROLET	D-20		1985/1987	
C-0105	RESERVATÓRIO C/ TAMPA	GM - CHEVROLET	VERANEIO		1973/1988	
C-0106	RESERVATÓRIO C/ TAMPA E AVISO DE NÍVEL	GM - CHEVROLET	AGILE		2010/...	S/ABS
C-0106	RESERVATÓRIO C/ TAMPA E AVISO DE NÍVEL	GM - CHEVROLET	ASTRA		1995/1996	SIST. ATE
C-0106	RESERVATÓRIO C/ TAMPA E AVISO DE NÍVEL	GM - CHEVROLET	CELTA		2001/...	
C-0106	RESERVATÓRIO C/ TAMPA E AVISO DE NÍVEL	GM - CHEVROLET	CORSA		1994/2002	SIST. ATE
C-0106	RESERVATÓRIO C/ TAMPA E AVISO DE NÍVEL	GM - CHEVROLET	CORSA CLASSIC		2003/...	
C-0106	RESERVATÓRIO C/ TAMPA E AVISO DE NÍVEL	GM - CHEVROLET	CORSA PICK-UP		1995/2003	SIST. ATE
C-0106	RESERVATÓRIO C/ TAMPA E AVISO DE NÍVEL	GM - CHEVROLET	MONTANA		2011/...	S/ABS
C-0106	RESERVATÓRIO C/ TAMPA E AVISO DE NÍVEL	GM - CHEVROLET	PRISMA		2007/2012	
C-0106	RESERVATÓRIO C/ TAMPA E AVISO DE NÍVEL	GM - CHEVROLET	VECTRA		1994/1996	SIST. ATE
C-0107	RESERVATÓRIO C/ TAMPA E AVISO DE NÍVEL	FORD	ROYALE		1992/1996	S/ABS
C-0107	RESERVATÓRIO C/ TAMPA E AVISO DE NÍVEL	FORD	VERSAILLES		1991/1996	S/ABS
C-0107	RESERVATÓRIO C/ TAMPA E AVISO DE NÍVEL	TROLLER	T4		1997/2001	
C-0107	RESERVATÓRIO C/ TAMPA E AVISO DE NÍVEL	VOLKSWAGEN	QUANTUM		1985/2002	S/ABS
C-0107	RESERVATÓRIO C/ TAMPA E AVISO DE NÍVEL	VOLKSWAGEN	SANTANA		1984/2006	S/ABS
C-0108	RESERVATÓRIO C/ TAMPA	TOYOTA	BANDEIRANTE		1982/2001	
C-0108	RESERVATÓRIO C/ TAMPA	VOLKSWAGEN	GOL (G1)		1981/1984	C/SERVO
C-0108	RESERVATÓRIO C/ TAMPA	VOLKSWAGEN	PARATI (G1)		1983/1984	
C-0108	RESERVATÓRIO C/ TAMPA	VOLKSWAGEN	PASSAT		1977/1984	
C-0108	RESERVATÓRIO C/ TAMPA	VOLKSWAGEN	SAVEIRO (G1)		1982/1984	
C-0108	RESERVATÓRIO C/ TAMPA	VOLKSWAGEN	VOYAGE (G1)		1982/1984	

Tabela de Conversão	Polegadas	9/16"	5/8"	11/16"	7/10"	3/4"	13/16"	7/8"	15/16"	1"	1 1/16"	1 1/8"	1 1/4"	1 3/8"	1 1/2"	1 5/8"	1 3/4"	1 27/32"	2"
	Milímetros		14,28mm	15,87mm	17,46mm	17,78mm	19,05mm	20,63mm	22,22mm	23,81mm	25,40mm	26,98mm	28,57mm	31,75mm	34,92mm	38,10mm	41,27mm	44,45mm	46,83mm

PEÇA	DESCRIÇÃO	MARCA	VEÍCULO		ANOS	SOMENTE PARA
C-0109	RESERVATÓRIO C/ TAMP A E AVISO DE NÍVEL	AGRALE	1600 A/D RS/RD		1988/1996	
C-0109	RESERVATÓRIO C/ TAMP A E AVISO DE NÍVEL	AGRALE	1800 D RS/RD		1988/1996	
C-0109	RESERVATÓRIO C/ TAMP A E AVISO DE NÍVEL	AGRALE	VOLARE A5/V5		2002/...	
C-0109	RESERVATÓRIO C/ TAMP A E AVISO DE NÍVEL	AGRALE	VOLARE A6/V6		1998/...	
C-0109	RESERVATÓRIO C/ TAMP A E AVISO DE NÍVEL	GM - CHEVROLET	A-10		1988/1989	
C-0109	RESERVATÓRIO C/ TAMP A E AVISO DE NÍVEL	GM - CHEVROLET	A-20		1988/1996	
C-0109	RESERVATÓRIO C/ TAMP A E AVISO DE NÍVEL	GM - CHEVROLET	BONANZA		1990/1996	
C-0109	RESERVATÓRIO C/ TAMP A E AVISO DE NÍVEL	GM - CHEVROLET	C-10/14/15/16		1988/1989	
C-0109	RESERVATÓRIO C/ TAMP A E AVISO DE NÍVEL	GM - CHEVROLET	C-20		1988/1996	
C-0109	RESERVATÓRIO C/ TAMP A E AVISO DE NÍVEL	GM - CHEVROLET	D-20		1988/1996	
C-0109	RESERVATÓRIO C/ TAMP A E AVISO DE NÍVEL	GM - CHEVROLET	VERANEIO		1989/1996	
C-0111	RESERVATÓRIO C/ TAMP A E AVISO DE NÍVEL	FORD	F-1000		1988/1998	
C-0111	RESERVATÓRIO C/ TAMP A E AVISO DE NÍVEL	FORD - CAMINHÕES	F-4000		1992/1998	SIST. BOSCH



---

# REPARO

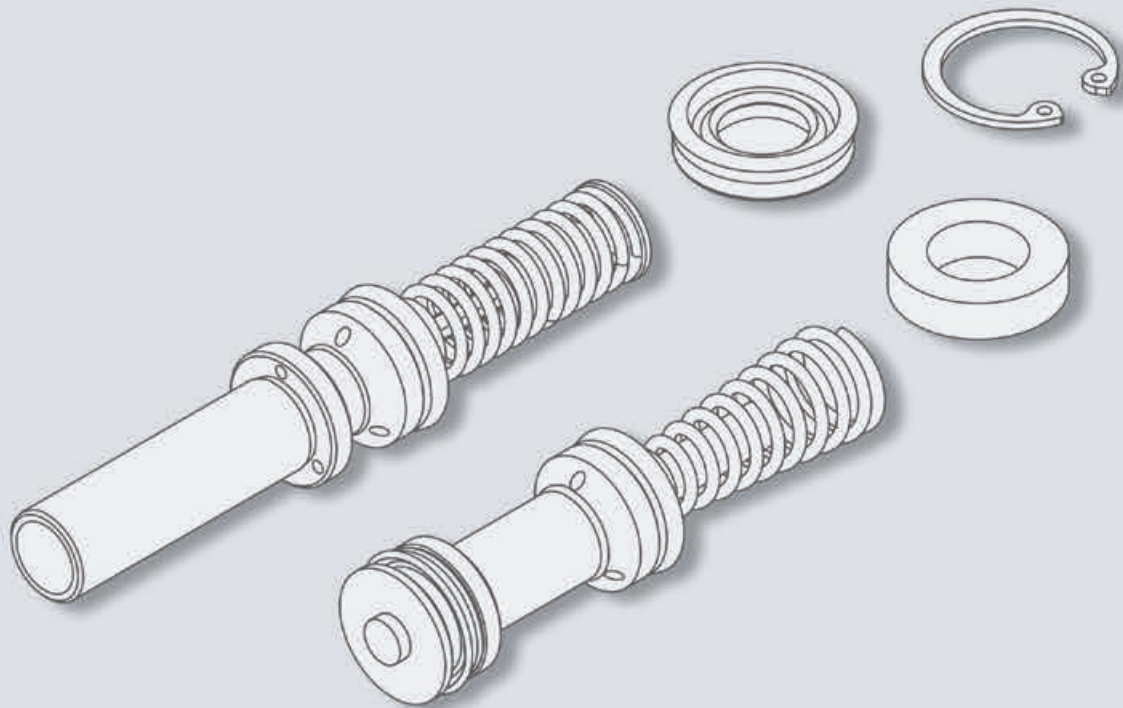



PEÇA	DESCRIÇÃO	MARCA	VEÍCULO		ANOS	SOMENTE PARA
C-1002	REPARO DO CILINDRO MESTRE DUPLO 22,22mm	GM - CHEVROLET	CARAVAN		1981/1989	P/ CILINDRO BENDIX 2258655
C-1002	REPARO DO CILINDRO MESTRE DUPLO 22,22mm	GM - CHEVROLET	OPALA		1981/1989	P/ CILINDRO BENDIX 2258655
C-1003	REPARO DO CILINDRO MESTRE DUPLO 20,63mm	GM - CHEVROLET	CHEVETTE		1973/1986	C/SERVO E S/SERVO
C-1003	REPARO DO CILINDRO MESTRE DUPLO 20,63mm	GM - CHEVROLET	CHEVY		1983/1986	C/SERVO E S/SERVO
C-1003	REPARO DO CILINDRO MESTRE DUPLO 20,63mm	GM - CHEVROLET	MARAJÓ		1981/1986	C/SERVO E S/SERVO
C-1004	REPARO DO CILINDRO MESTRE SIMPLES 31,75mm	GM - CAMINHÕES	6500		1956/1971	
C-1004	REPARO DO CILINDRO MESTRE SIMPLES 31,75mm	GM - CAMINHÕES	C-60		1964/1971	
C-1004	REPARO DO CILINDRO MESTRE SIMPLES 31,75mm	GM - CAMINHÕES	D-60 (11000/12000)		1964/1971	
C-1004	REPARO DO CILINDRO MESTRE SIMPLES 31,75mm	PUMA - CAMINHÕES	4T		1978/1984	
C-1006	REPARO DO CILINDRO MESTRE DUPLO 31,75mm	MERCEDES BENZ - CAMINHÕES	L/LA/LS-1111		1965/1970	SIST. BENDIX
C-1006	REPARO DO CILINDRO MESTRE DUPLO 31,75mm	MERCEDES BENZ - CAMINHÕES	L/LA/LK/LS/OF-1113		1965/1983	SIST. BENDIX
C-1008	REPARO DO CILINDRO MESTRE DUPLO 22,22mm	GM - CHEVROLET	CARAVAN		1981/1992	P/ CILINDRO VARGA
C-1008	REPARO DO CILINDRO MESTRE DUPLO 22,22mm	GM - CHEVROLET	OPALA		1981/1992	P/ CILINDRO VARGA
C-1011	REPARO DO CILINDRO MESTRE SIMPLES 38,10mm	CHRYSLER - CAMINHÕES	D-700		1970/1981	
C-1011	REPARO DO CILINDRO MESTRE SIMPLES 38,10mm	FORD - CAMINHÕES	F-600		1960/1980	
C-1011	REPARO DO CILINDRO MESTRE SIMPLES 38,10mm	FORD - CAMINHÕES	F-7000		1972/1980	
C-1011	REPARO DO CILINDRO MESTRE SIMPLES 38,10mm	FORD - CAMINHÕES	F-11000		1980/1985	
C-1012	REPARO DO CILINDRO MESTRE DUPLO 22,00mm	FORD	ESCORT		1983/1992	SIST. BENDIX
C-1012	REPARO DO CILINDRO MESTRE DUPLO 22,00mm	FORD	ESCORT HOBBY		1993/1996	
C-1012	REPARO DO CILINDRO MESTRE DUPLO 22,00mm	FORD	VERONA		1990/1992	
C-1012	REPARO DO CILINDRO MESTRE DUPLO 22,00mm	VOLKSWAGEN	APOLLO		1990/1992	
C-1013	REPARO DO CILINDRO MESTRE SIMPLES 25,40mm	AGRALE	1100 D		1982/1983	
C-1013	REPARO DO CILINDRO MESTRE SIMPLES 25,40mm	AGRALE	1200 A		1983/1985	
C-1013	REPARO DO CILINDRO MESTRE SIMPLES 25,40mm	AGRALE	1600 A/D RS/RD		1983/1985	
C-1013	REPARO DO CILINDRO MESTRE SIMPLES 25,40mm	FORD	AERO/ITAMARATY		1961/1971	
C-1013	REPARO DO CILINDRO MESTRE SIMPLES 25,40mm	FORD	F-75		1960/1982	
C-1013	REPARO DO CILINDRO MESTRE SIMPLES 25,40mm	FORD	JEEP		1960/1981	
C-1013	REPARO DO CILINDRO MESTRE SIMPLES 25,40mm	FORD	RURAL		1960/1977	
C-1015	REPARO DO CILINDRO MESTRE SIMPLES 38,10mm	VOLKSWAGEN - CAMINHÕES	Jun-80		1982/1986	
C-1015	REPARO DO CILINDRO MESTRE SIMPLES 38,10mm	VOLKSWAGEN - CAMINHÕES	11-130		1982/1985	
C-1017	REPARO DO CILINDRO MESTRE DUPLO 20,63mm	GM - CHEVROLET	MONZA		1981/1987	
C-1019	REPARO DO CILINDRO MESTRE DUPLO 22,22mm	FORD	BELINA II		1978/1991	
C-1019	REPARO DO CILINDRO MESTRE DUPLO 22,22mm	FORD	CORCEL II		1978/1986	
C-1019	REPARO DO CILINDRO MESTRE DUPLO 22,22mm	FORD	DEL REY		1981/1991	
C-1019	REPARO DO CILINDRO MESTRE DUPLO 22,22mm	FORD	PAMPA		1982/1997	
C-1020	REPARO DO CILINDRO MESTRE DUPLO 23,81mm	TOYOTA	BANDEIRANTE		1982/1996	C/ <-
C-1021	REPARO DO CILINDRO MESTRE DUPLO 23,81mm	ALFA ROMEO	2300		1983/1986	
C-1021	REPARO DO CILINDRO MESTRE DUPLO 23,81mm	GURGEL	G-15		1982/1984	
C-1021	REPARO DO CILINDRO MESTRE DUPLO 23,81mm	GURGEL	G-800 CS/CD		1983/1991	
C-1021	REPARO DO CILINDRO MESTRE DUPLO 23,81mm	GURGEL	X-15/CARAJÁS		1985/1993	
C-1021	REPARO DO CILINDRO MESTRE DUPLO 23,81mm	VOLKSWAGEN	KOMBI		1982/...	
C-1023	REPARO DO CILINDRO MESTRE SIMPLES 31,75mm	FORD - CAMINHÕES	FB-4000		1982/1985	
C-1023	REPARO DO CILINDRO MESTRE SIMPLES 31,75mm	MERCEDES BENZ - CAMINHÕES	LO-814		1996/...	
C-1023	REPARO DO CILINDRO MESTRE SIMPLES 31,75mm	MERCEDES BENZ - CAMINHÕES	L/O-912		1996/...	SIST. VARGA
C-1023	REPARO DO CILINDRO MESTRE SIMPLES 31,75mm	MERCEDES BENZ - CAMINHÕES	L-914/914 E		1996/...	
C-1023	REPARO DO CILINDRO MESTRE SIMPLES 31,75mm	MERCEDES BENZ - CAMINHÕES	L-1114		1996/...	
C-1023	REPARO DO CILINDRO MESTRE SIMPLES 31,75mm	VOLKSWAGEN - CAMINHÕES	Jun-90		1982/1986	
C-1023	REPARO DO CILINDRO MESTRE SIMPLES 31,75mm	VOLKSWAGEN - CAMINHÕES	Jul-90		1987/1994	
C-1023	REPARO DO CILINDRO MESTRE SIMPLES 31,75mm	VOLKSWAGEN - CAMINHÕES	7-110 S		1988/1994	
C-1027	REPARO DO CILINDRO MESTRE DUPLO 20,63mm	FORD	VERSAILLES		1991/1994	S/ABS
C-1027	REPARO DO CILINDRO MESTRE DUPLO 20,63mm	VOLKSWAGEN	GOL (G1)		1981/1996	C/SERVO
C-1027	REPARO DO CILINDRO MESTRE DUPLO 20,63mm	VOLKSWAGEN	GOL (G2)		1995/2005	MOTOR 1.0/1.6/1.8 S/ABS
C-1027	REPARO DO CILINDRO MESTRE DUPLO 20,63mm	VOLKSWAGEN	GOL (G3)		2000/2000	MOTOR 1.0/1.6/1.8 S/ABS
C-1027	REPARO DO CILINDRO MESTRE DUPLO 20,63mm	VOLKSWAGEN	PARATI (G1)		1983/1996	
C-1027	REPARO DO CILINDRO MESTRE DUPLO 20,63mm	VOLKSWAGEN	PASSAT		1977/1989	C/SERVO
C-1027	REPARO DO CILINDRO MESTRE DUPLO 20,63mm	VOLKSWAGEN	SANTANA		1984/1994	S/ABS
C-1027	REPARO DO CILINDRO MESTRE DUPLO 20,63mm	VOLKSWAGEN	SAVEIRO (G1)		1982/1997	
C-1027	REPARO DO CILINDRO MESTRE DUPLO 20,63mm	VOLKSWAGEN	VOYAGE (G1)		1982/1996	
C-1028	REPARO DO CILINDRO MESTRE DUPLO 20,63mm	FIAT	147/SPAZIO		1983/1987	SIST. VARGA
C-1028	REPARO DO CILINDRO MESTRE DUPLO 20,63mm	FIAT	FIORINO (mod. 147)		1983/1988	SIST. VARGA
C-1028	REPARO DO CILINDRO MESTRE DUPLO 20,63mm	FIAT	OGGI		1983/1985	SIST. VARGA
C-1028	REPARO DO CILINDRO MESTRE DUPLO 20,63mm	FIAT	PANORAMA		1983/1987	SIST. VARGA

Tabela de Conversão	Polegadas	9/16"	5/8"	11/16"	7/10"	3/4"	13/16"	7/8"	15/16"	1"	1 1/16"	1 1/8"	1 1/4"	1 3/8"	1 1/2"	1 5/8"	1 3/4"	1 27/32"	2"
	Milímetros	14,28mm	15,87mm	17,46mm	17,78mm	19,05mm	20,63mm	22,22mm	23,81mm	25,40mm	26,98mm	28,57mm	31,75mm	34,92mm	38,10mm	41,27mm	44,45mm	46,83mm	50,80mm

PEÇA	DESCRIÇÃO	MARCA	VEÍCULO		ANOS	SOMENTE PARA
C-1029	REPARO DO CILINDRO MESTRE DUPL0 20,63mm	GM - CHEVROLET	CHEVETTE		1987/1994	SIST. ATE
C-1029	REPARO DO CILINDRO MESTRE DUPL0 20,63mm	GM - CHEVROLET	CHEVY		1987/1995	SIST. ATE
C-1029	REPARO DO CILINDRO MESTRE DUPL0 20,63mm	GM - CHEVROLET	MARAJÓ		1987/1989	SIST. ATE
C-1030	REPARO DO CILINDRO MESTRE DUPL0 20,63mm	GM - CHEVROLET	CHEVETTE		1987/1994	SIST. BOSCH
C-1030	REPARO DO CILINDRO MESTRE DUPL0 20,63mm	GM - CHEVROLET	CHEVY		1987/1995	SIST. BOSCH
C-1030	REPARO DO CILINDRO MESTRE DUPL0 20,63mm	GM - CHEVROLET	MARAJÓ		1987/1989	SIST. BOSCH
C-1031	REPARO DO CILINDRO MESTRE SIMPLES 38,10mm	GM - CAMINHÕES	D-60 (11000/12000)		1985/1996	
C-1034	REPARO DO CILINDRO MESTRE SIMPLES 38,10mm	FORD - CAMINHÕES	F-4000		1985/1992	
C-1034	REPARO DO CILINDRO MESTRE SIMPLES 38,10mm	FORD - CAMINHÕES	F-11000		1986/1992	
C-1035	REPARO DO CILINDRO MESTRE SIMPLES 19,05mm	VOLKSWAGEN	FUSCA		1957/1966	
C-1035	REPARO DO CILINDRO MESTRE SIMPLES 19,05mm	VOLKSWAGEN	KARMANN GHIA		1957/1966	
C-1039	REPARO DO CILINDRO MESTRE SIMPLES 31,75mm	MERCEDES BENZ - CAMINHÕES	0-364		1982/1989	CIRCUITO DIANTEIRO
C-1040	REPARO DO CILINDRO MESTRE SIMPLES 31,75mm	CATERPILLAR	MOTONIVELADORA		1984/...	
C-1040	REPARO DO CILINDRO MESTRE SIMPLES 31,75mm	FIAT ALLIS	134BR		.../1983	
C-1040	REPARO DO CILINDRO MESTRE SIMPLES 31,75mm	FIAT ALLIS	1500BR		.../1983	
C-1040	REPARO DO CILINDRO MESTRE SIMPLES 31,75mm	FIAT ALLIS	1911BR		.../1983	
C-1040	REPARO DO CILINDRO MESTRE SIMPLES 31,75mm	FIAT - CAMINHÕES	120		1979/1980	
C-1040	REPARO DO CILINDRO MESTRE SIMPLES 31,75mm	MERCEDES BENZ - CAMINHÕES	L/LA/LK/LP/LS/O/OH-321		1957/1965	
C-1045	REPARO DO CILINDRO MESTRE SIMPLES 22,22mm	TOYOTA	BANDEIRANTE		1966/1981	
C-1047	REPARO DO CILINDRO MESTRE DUPL0 20,63mm	FORD	BELINA II		1978/1991	P/ CILINDRO VARGA 13/16"
C-1047	REPARO DO CILINDRO MESTRE DUPL0 20,63mm	FORD	CORCEL II		1978/1986	P/ CILINDRO VARGA 13/16"
C-1047	REPARO DO CILINDRO MESTRE DUPL0 20,63mm	FORD	DEL REY		1981/1991	P/ CILINDRO VARGA 13/16"
C-1048	REPARO DO CILINDRO MESTRE SIMPLES 17,46mm	GURGEL	X-12/TOCANTINS		1969/1977	
C-1048	REPARO DO CILINDRO MESTRE SIMPLES 17,46mm	PUMA	GT/GTE/GTS		1968/1973	
C-1048	REPARO DO CILINDRO MESTRE SIMPLES 17,46mm	VOLKSWAGEN	FUSCA		1967/1976	C/ <-
C-1048	REPARO DO CILINDRO MESTRE SIMPLES 17,46mm	VOLKSWAGEN	KARMANN GHIA		1967/1969	
C-1049	REPARO DO CILINDRO MESTRE SIMPLES 22,22mm	GURGEL	E-400		1981/1983	
C-1049	REPARO DO CILINDRO MESTRE SIMPLES 22,22mm	GURGEL	X-20		1977/1979	
C-1049	REPARO DO CILINDRO MESTRE SIMPLES 22,22mm	VOLKSWAGEN	KOMBI		1957/1975	
C-1050	REPARO DO CILINDRO MESTRE DUPL0 28,57mm	GM - CAMINHÕES	D-40		1985/1997	
C-1051	REPARO DO CILINDRO MESTRE SIMPLES 25,40mm	GM - CHEVROLET	3100		1965/1967	
C-1051	REPARO DO CILINDRO MESTRE SIMPLES 25,40mm	GM - CHEVROLET	C-10/14/15/16		1968/1973	
C-1051	REPARO DO CILINDRO MESTRE SIMPLES 25,40mm	GM - CHEVROLET	VERANEIO		1968/1973	
C-1053	REPARO DO CILINDRO MESTRE SIMPLES 26,98mm	FORD	F-100		1956/1962	
C-1054	REPARO DO CILINDRO MESTRE SIMPLES 31,75mm	FORD - CAMINHÕES	F-350		1962/1974	
C-1055	REPARO DO CILINDRO MESTRE DUPL0 20,63mm	FORD	ROYALE		1992/1994	S/ABS
C-1055	REPARO DO CILINDRO MESTRE DUPL0 20,63mm	VOLKSWAGEN	QUANTUM		1985/1994	S/ABS
C-1059	REPARO DO CILINDRO MESTRE SIMPLES 31,75mm	CHRYSLER - CAMINHÕES	D-400		1970/1978	
C-1059	REPARO DO CILINDRO MESTRE SIMPLES 31,75mm	CHRYSLER - CAMINHÕES	P-400		1978/1981	
C-1059	REPARO DO CILINDRO MESTRE SIMPLES 31,75mm	FIAT ALLIS	FR10M		1983/...	
C-1059	REPARO DO CILINDRO MESTRE SIMPLES 31,75mm	FIAT ALLIS	FR11M		1983/...	
C-1059	REPARO DO CILINDRO MESTRE SIMPLES 31,75mm	FIAT ALLIS	FR12M		1983/...	
C-1060	REPARO DO CILINDRO MESTRE DUPL0 19,05mm	GURGEL	X-12/TOCANTINS		1978/1993	
C-1060	REPARO DO CILINDRO MESTRE DUPL0 19,05mm	GURGEL	XEF		1984/1986	
C-1060	REPARO DO CILINDRO MESTRE DUPL0 19,05mm	PUMA	GT/GTE/GTS		1977/1984	
C-1060	REPARO DO CILINDRO MESTRE DUPL0 19,05mm	VOLKSWAGEN	BRASILIA		1977/1982	
C-1060	REPARO DO CILINDRO MESTRE DUPL0 19,05mm	VOLKSWAGEN	FUSCA		1977/1996	
C-1060	REPARO DO CILINDRO MESTRE DUPL0 19,05mm	VOLKSWAGEN	SP-1/SP-2		1972/1975	
C-1060	REPARO DO CILINDRO MESTRE DUPL0 19,05mm	VOLKSWAGEN	VARIANT		1977/1977	
C-1060	REPARO DO CILINDRO MESTRE DUPL0 19,05mm	VOLKSWAGEN	VARIANT II		1978/1980	
C-1061	REPARO DO CILINDRO MESTRE SIMPLES 19,05mm	VOLKSWAGEN	BRASILIA		1973/1976	
C-1061	REPARO DO CILINDRO MESTRE SIMPLES 19,05mm	VOLKSWAGEN	FUSCA		1970/1976	C/ <-
C-1061	REPARO DO CILINDRO MESTRE SIMPLES 19,05mm	VOLKSWAGEN	SEDAN 1600 4 PORTAS		1969/1971	
C-1061	REPARO DO CILINDRO MESTRE SIMPLES 19,05mm	VOLKSWAGEN	TL		1969/1976	
C-1061	REPARO DO CILINDRO MESTRE SIMPLES 19,05mm	VOLKSWAGEN	VARIANT		1970/1976	
C-1062	REPARO DO CILINDRO MESTRE SIMPLES 19,05mm	FORD	BELINA		1969/1976	
C-1062	REPARO DO CILINDRO MESTRE SIMPLES 19,05mm	FORD	CORCEL		1968/1976	
C-1067	REPARO DO CILINDRO MESTRE SIMPLES 38,10mm	GM - CAMINHÕES	C-60		1972/1984	
C-1067	REPARO DO CILINDRO MESTRE SIMPLES 38,10mm	GM - CAMINHÕES	D-60 (11000/12000)		1972/1984	
C-1067	REPARO DO CILINDRO MESTRE SIMPLES 38,10mm	GM - CAMINHÕES	D-80 (19000)		1982/1984	
C-1070	REPARO DO CILINDRO MESTRE SIMPLES 34,92mm	MERCEDES BENZ - CAMINHÕES	0-355		1970/1978	
C-1070	REPARO DO CILINDRO MESTRE SIMPLES 34,92mm	MERCEDES BENZ - CAMINHÕES	O/OH-362/362 A		1978/1989	MOD. 0

Polgadas	9/16"	5/8"	11/16"	7/10"	3/4"	13/16"	7/8"	15/16"	1"	1 1/16"	1 1/8"	1 1/4"	1 3/8"	1 1/2"	1 5/8"	1 3/4"	1 27/32"	2"
Milímetros	14,28mm	15,87mm	17,46mm	17,78mm	19,05mm	20,63mm	22,22mm	23,81mm	25,40mm	26,98mm	28,57mm	31,75mm	34,92mm	38,10mm	41,27mm	44,45mm	46,83mm	50,80mm

PEÇA	DESCRIÇÃO	MARCA	VEÍCULO		ANOS	SOMENTE PARA
C-1070	REPARO DO CILINDRO MESTRE SIMPLES 34,92mm	MERCEDES BENZ - CAMINHÕES	0-364		1978/1981	
C-1070	REPARO DO CILINDRO MESTRE SIMPLES 34,92mm	MERCEDES BENZ - CAMINHÕES	0-364		1982/1989	CIRCUITO TRASEIRO
C-1070	REPARO DO CILINDRO MESTRE SIMPLES 34,92mm	MERCEDES BENZ - CAMINHÕES	L/LA/LK/LS/OF-1113		1983/1989	MOD. L
C-1070	REPARO DO CILINDRO MESTRE SIMPLES 34,92mm	MERCEDES BENZ - CAMINHÕES	L-1116		1983/1989	
C-1070	REPARO DO CILINDRO MESTRE SIMPLES 34,92mm	MERCEDES BENZ - CAMINHÕES	L/LS/LK/OF/OH-1313		1983/1989	
C-1070	REPARO DO CILINDRO MESTRE SIMPLES 34,92mm	MERCEDES BENZ - CAMINHÕES	OH-1416		1970/1989	
C-1070	REPARO DO CILINDRO MESTRE SIMPLES 34,92mm	MERCEDES BENZ - CAMINHÕES	L/LP/OH-1419		1970/1989	
C-1070	REPARO DO CILINDRO MESTRE SIMPLES 34,92mm	MERCEDES BENZ - CAMINHÕES	L/LK-1513/1516		1971/1976	
C-1070	REPARO DO CILINDRO MESTRE SIMPLES 34,92mm	MERCEDES BENZ - CAMINHÕES	L-1519		1973/1976	
C-1070	REPARO DO CILINDRO MESTRE SIMPLES 34,92mm	MERCEDES BENZ - CAMINHÕES	L/LB/LK-2213		1973/1990	
C-1077	REPARO DO CILINDRO MESTRE DUPLO 31,75mm	MERCEDES BENZ - CAMINHÕES	L/LA/LK/LP/LS/O/OH-321		1965/1970	
C-1077	REPARO DO CILINDRO MESTRE DUPLO 31,75mm	MERCEDES BENZ - CAMINHÕES	L/LA/LS-1111		1965/1970	SIST. VARGA
C-1077	REPARO DO CILINDRO MESTRE DUPLO 31,75mm	MERCEDES BENZ - CAMINHÕES	L/LA/LK/LS/OF-1113		1965/1983	SIST. VARGA
C-1077	REPARO DO CILINDRO MESTRE DUPLO 31,75mm	MERCEDES BENZ - CAMINHÕES	L/LA/LK/LS/OF-1113		1983/1989	MOD. LA/LK/LS
C-1078	REPARO DO CILINDRO MESTRE DUPLO 38,10mm	MERCEDES BENZ - CAMINHÕES	O/OH-362/362 A		1970/1978	MOD. OH
C-1078	REPARO DO CILINDRO MESTRE DUPLO 38,10mm	MERCEDES BENZ - CAMINHÕES	L/LS/LK/OF/OH-1313		1970/1983	
C-1078	REPARO DO CILINDRO MESTRE DUPLO 38,10mm	MERCEDES BENZ - CAMINHÕES	L/OH-1316		1970/1989	
C-1078	REPARO DO CILINDRO MESTRE DUPLO 38,10mm	MERCEDES BENZ - CAMINHÕES	OH-1517		1970/1976	
C-1079	REPARO DO CILINDRO MESTRE SIMPLES 23,81mm	GURGEL	G-15		1980/1981	
C-1079	REPARO DO CILINDRO MESTRE SIMPLES 23,81mm	GURGEL	G-800 CS/CD		1983/1983	
C-1079	REPARO DO CILINDRO MESTRE SIMPLES 23,81mm	MERCEDES BENZ - CAMINHÕES	L/LO-708 D/E		1987/1988	
C-1079	REPARO DO CILINDRO MESTRE SIMPLES 23,81mm	VOLKSWAGEN	KOMBI		1976/1982	
C-1082	REPARO DO CILINDRO MESTRE DUPLO 25,40mm	GM - CHEVROLET	C-10/14/15/16		1977/1978	
C-1082	REPARO DO CILINDRO MESTRE DUPLO 25,40mm	GM - CHEVROLET	VERANEIO		1977/1978	
C-1085	REPARO DO CILINDRO MESTRE DUPLO 22,22mm	GM - CHEVROLET	CARAVAN		1975/1980	
C-1085	REPARO DO CILINDRO MESTRE DUPLO 22,22mm	GM - CHEVROLET	OPALA		1975/1980	C/SERVO
C-1085	REPARO DO CILINDRO MESTRE DUPLO 22,22mm	PUMA	GTB		1974/1980	
C-1090	REPARO DO CILINDRO MESTRE DUPLO 19,05mm	GM - CHEVROLET	CHEVETTE		1976/1980	P/ CILINDRO BENDIX 3/4" C/SERVO E S/SERVO
C-1092	REPARO DO CILINDRO MESTRE DUPLO 25,40mm	AGRALE	1600 A/D RS/RD		1986/1989	
C-1092	REPARO DO CILINDRO MESTRE DUPLO 25,40mm	AGRALE	1800 D RS/RD		1988/1989	
C-1092	REPARO DO CILINDRO MESTRE DUPLO 25,40mm	FORD	F-100		1982/1987	
C-1092	REPARO DO CILINDRO MESTRE DUPLO 25,40mm	FORD	F-1000		1979/1992	
C-1092	REPARO DO CILINDRO MESTRE DUPLO 25,40mm	FORD	F-2000		1980/1987	
C-1092	REPARO DO CILINDRO MESTRE DUPLO 25,40mm	GM - CHEVROLET	A-10		1979/1988	
C-1092	REPARO DO CILINDRO MESTRE DUPLO 25,40mm	GM - CHEVROLET	A-20		1985/1988	
C-1092	REPARO DO CILINDRO MESTRE DUPLO 25,40mm	GM - CHEVROLET	C-10/14/15/16		1973/1976	
C-1092	REPARO DO CILINDRO MESTRE DUPLO 25,40mm	GM - CHEVROLET	C-10/14/15/16		1979/1989	
C-1092	REPARO DO CILINDRO MESTRE DUPLO 25,40mm	GM - CHEVROLET	C-20		1985/1988	
C-1092	REPARO DO CILINDRO MESTRE DUPLO 25,40mm	GM - CHEVROLET	D-10		1979/1984	
C-1092	REPARO DO CILINDRO MESTRE DUPLO 25,40mm	GM - CHEVROLET	D-20		1985/1988	
C-1092	REPARO DO CILINDRO MESTRE DUPLO 25,40mm	GM - CHEVROLET	VERANEIO		1973/1976	
C-1092	REPARO DO CILINDRO MESTRE DUPLO 25,40mm	GM - CHEVROLET	VERANEIO		1979/1988	
C-1093	REPARO DO CILINDRO MESTRE SIMPLES 22,22mm	FORD	F-100		1976/1982	
C-1093	REPARO DO CILINDRO MESTRE SIMPLES 22,22mm	FORD	MAVERICK		1973/1976	
C-1094	REPARO DO CILINDRO MESTRE DUPLO 22,22mm	FORD	MAVERICK		1977/1979	S/SERVO
C-1098	REPARO DO CILINDRO MESTRE DUPLO 19,05mm	FIAT	147/SPAZIO		1976/1987	SIST. ATE C/ E S/SERVO
C-1098	REPARO DO CILINDRO MESTRE DUPLO 19,05mm	FIAT	ELBA		1986/1991	
C-1098	REPARO DO CILINDRO MESTRE DUPLO 19,05mm	FIAT	FIORINO (mod. 147)		1978/1988	SIST. ATE
C-1098	REPARO DO CILINDRO MESTRE DUPLO 19,05mm	FIAT	FIORINO (mod. Uno)		1988/1991	
C-1098	REPARO DO CILINDRO MESTRE DUPLO 19,05mm	FIAT	OGGI		1983/1985	SIST. ATE
C-1098	REPARO DO CILINDRO MESTRE DUPLO 19,05mm	FIAT	PANORAMA		1980/1987	SIST. ATE
C-1098	REPARO DO CILINDRO MESTRE DUPLO 19,05mm	FIAT	PRÊMIO		1985/1991	
C-1098	REPARO DO CILINDRO MESTRE DUPLO 19,05mm	FIAT	UNO		1984/1991	
C-1098	REPARO DO CILINDRO MESTRE DUPLO 19,05mm	GURGEL	BR-800/SUPERMINI		1989/1993	
C-1099	REPARO DO CILINDRO MESTRE DUPLO 19,05mm	FORD	BELINA		1977/1977	
C-1099	REPARO DO CILINDRO MESTRE DUPLO 19,05mm	FORD	BELINA II		1978/1980	S/SERVO
C-1099	REPARO DO CILINDRO MESTRE DUPLO 19,05mm	FORD	CORCEL		1977/1977	
C-1099	REPARO DO CILINDRO MESTRE DUPLO 19,05mm	FORD	CORCEL II		1978/1980	S/SERVO
C-1101	REPARO DO CILINDRO MESTRE SIMPLES 31,75mm	FORD - CAMINHÕES	F-350		1974/1975	
C-1101	REPARO DO CILINDRO MESTRE SIMPLES 31,75mm	FORD - CAMINHÕES	F-400		1975/1977	
C-1101	REPARO DO CILINDRO MESTRE SIMPLES 31,75mm	FORD - CAMINHÕES	F-4000		1975/1984	

Tabela de Conversão	Polegadas	9/16"	5/8"	11/16"	7/10"	3/4"	13/16"	7/8"	15/16"	1"	1 1/16"	1 1/8"	1 1/4"	1 3/8"	1 1/2"	1 5/8"	1 3/4"	1 27/32"	2"
	Milímetros	14,28mm	15,87mm	17,46mm	17,78mm	19,05mm	20,63mm	22,22mm	23,81mm	25,40mm	26,98mm	28,57mm	31,75mm	34,92mm	38,10mm	41,27mm	44,45mm	46,83mm	50,80mm



PEÇA	DESCRIÇÃO	MARCA	VEÍCULO		ANOS	SOMENTE PARA
C-1103	REPARO DO CILINDRO MESTRE SIMPLES 25,40mm	FORD	F-100		1962/1976	
C-1104	REPARO DO CILINDRO MESTRE SIMPLES 22,22mm	MERCEDES BENZ - CAMINHÕES	L/L0-608 D/E		1972/1986	
C-1109	REPARO DO CILINDRO MESTRE DUPL0 22,22mm	GM - CHEVROLET	IPANEMA		1990/1998	SIST. VARGA E BOSCH
C-1109	REPARO DO CILINDRO MESTRE DUPL0 22,22mm	GM - CHEVROLET	KADETT		1989/1998	SIST. VARGA E BOSCH
C-1109	REPARO DO CILINDRO MESTRE DUPL0 22,22mm	GM - CHEVROLET	MONZA		1988/1996	SIST. VARGA E BOSCH S/ABS
C-1110	REPARO DO CILINDRO MESTRE DUPL0 20,63mm	FIAT	DUNA		1994/1996	SIST. ATE
C-1110	REPARO DO CILINDRO MESTRE DUPL0 20,63mm	FIAT	ELBA		1991/1996	SIST. ATE
C-1110	REPARO DO CILINDRO MESTRE DUPL0 20,63mm	FIAT	FIORINO (mod. Uno)		1991/1993	SIST. ATE
C-1110	REPARO DO CILINDRO MESTRE DUPL0 20,63mm	FIAT	PRÊMIO		1991/1996	SIST. ATE
C-1110	REPARO DO CILINDRO MESTRE DUPL0 20,63mm	FIAT	UNO		1987/1991	MOD. 1.5R/1.6R
C-1110	REPARO DO CILINDRO MESTRE DUPL0 20,63mm	FIAT	UNO		1991/2001	SIST. ATE
C-1111	REPARO DO CILINDRO MESTRE SIMPLES 22,22mm	MERCEDES BENZ - CAMINHÕES	L/L0-912		1989/...	SIST. ATE CIRCUITO TRASEIRO
C-1112	REPARO DO CILINDRO MESTRE SIMPLES 28,57mm	MERCEDES BENZ - CAMINHÕES	L/L0-912		1989/...	SIST. ATE CIRCUITO DIANTEIRO
C-1113	REPARO DO CILINDRO MESTRE DUPL0 31,75mm	MERCEDES BENZ - CAMINHÕES	L-709		1989/1996	
C-1113	REPARO DO CILINDRO MESTRE DUPL0 31,75mm	MERCEDES BENZ - CAMINHÕES	L-710		1996/2002	
C-1114	REPARO DO CILINDRO MESTRE DUPL0 28,57mm	AGRALE	1600 A/D RS/RD		1990/1996	
C-1114	REPARO DO CILINDRO MESTRE DUPL0 28,57mm	AGRALE	1800 D RS/RD		1990/1996	
C-1114	REPARO DO CILINDRO MESTRE DUPL0 28,57mm	AGRALE	VOLARE A5/V5		2002/...	
C-1114	REPARO DO CILINDRO MESTRE DUPL0 28,57mm	AGRALE	VOLARE A6/V6		1998/...	
C-1114	REPARO DO CILINDRO MESTRE DUPL0 28,57mm	GM - CHEVROLET	A-10		1989/1989	
C-1114	REPARO DO CILINDRO MESTRE DUPL0 28,57mm	GM - CHEVROLET	A-20		1989/1992	
C-1114	REPARO DO CILINDRO MESTRE DUPL0 28,57mm	GM - CHEVROLET	BONANZA		1990/1992	
C-1114	REPARO DO CILINDRO MESTRE DUPL0 28,57mm	GM - CHEVROLET	C-10/14/15/16		1989/1989	
C-1114	REPARO DO CILINDRO MESTRE DUPL0 28,57mm	GM - CHEVROLET	C-20		1989/1992	
C-1114	REPARO DO CILINDRO MESTRE DUPL0 28,57mm	GM - CHEVROLET	D-20		1989/1992	
C-1114	REPARO DO CILINDRO MESTRE DUPL0 28,57mm	GM - CHEVROLET	VERANEIO		1989/1992	
C-1116	REPARO DO CILINDRO MESTRE DUPL0 20,63mm	VOLKSWAGEN	GOL (G1)		1988/1996	P/ CILINDRO ATE
C-1116	REPARO DO CILINDRO MESTRE DUPL0 20,63mm	VOLKSWAGEN	GOL (G2)		1995/2005	MOTOR 1.0/1.6/1.8 C/ CILINDRO ATE
C-1116	REPARO DO CILINDRO MESTRE DUPL0 20,63mm	VOLKSWAGEN	GOL (G3)		2000/2000	SIST. ATE C/MOTOR 1.0/1.6/1.8
C-1116	REPARO DO CILINDRO MESTRE DUPL0 20,63mm	VOLKSWAGEN	PARATI (G1)		1988/1996	P/ CILINDRO ATE
C-1116	REPARO DO CILINDRO MESTRE DUPL0 20,63mm	VOLKSWAGEN	SAVEIRO (G1)		1988/1997	P/ CILINDRO ATE
C-1116	REPARO DO CILINDRO MESTRE DUPL0 20,63mm	VOLKSWAGEN	VOYAGE (G1)		1988/1996	P/ CILINDRO ATE
C-1117	REPARO DO CILINDRO MESTRE DUPL0 22,22mm	GM - CHEVROLET	CARAVAN		1981/1990	SIST. BOSCH
C-1117	REPARO DO CILINDRO MESTRE DUPL0 22,22mm	GM - CHEVROLET	OPALA		1981/1990	SIST. BOSCH
C-1118	REPARO DO CILINDRO MESTRE DUPL0 22,22mm	FIAT	FIORINO (mod. Uno)		1994/1994	P/ CILINDRO BENDIX 2261700S
C-1118	REPARO DO CILINDRO MESTRE DUPL0 22,22mm	FIAT	TEMPRA		1992/1994	P/ CILINDRO BENDIX 2261700S
C-1118	REPARO DO CILINDRO MESTRE DUPL0 22,22mm	FIAT	UNO TURBO		1994/1994	
C-1119	REPARO DO CILINDRO MESTRE DUPL0 22,22mm	FIAT	FIORINO (mod. Uno)		1994/...	SIST. BOSCH
C-1119	REPARO DO CILINDRO MESTRE DUPL0 22,22mm	FIAT	PALIO		1998/...	SIST. BOSCH S/ABS
C-1119	REPARO DO CILINDRO MESTRE DUPL0 22,22mm	FIAT	PALIO WEEKEND		1998/...	SIST. BOSCH S/ABS
C-1119	REPARO DO CILINDRO MESTRE DUPL0 22,22mm	FIAT	SIENA		1998/...	SIST. BOSCH S/ABS
C-1119	REPARO DO CILINDRO MESTRE DUPL0 22,22mm	FIAT	STRADA		1999/...	SIST. BOSCH S/ABS
C-1119	REPARO DO CILINDRO MESTRE DUPL0 22,22mm	FIAT	TEMPRA		1992/1999	MOTOR 2.0 8V/16V S/ABS
C-1119	REPARO DO CILINDRO MESTRE DUPL0 22,22mm	FIAT	UNO TURBO		1994/1996	
C-1120	REPARO DO CILINDRO MESTRE DUPL0 20,63mm	FIAT	ELBA		1991/1994	P/ CILINDRO BENDIX 2260511S
C-1120	REPARO DO CILINDRO MESTRE DUPL0 20,63mm	FIAT	FIORINO (mod. Uno)		1991/1993	P/ CILINDRO BENDIX 2260511S
C-1120	REPARO DO CILINDRO MESTRE DUPL0 20,63mm	FIAT	PRÊMIO		1991/1994	P/ CILINDRO BENDIX 2260511S
C-1120	REPARO DO CILINDRO MESTRE DUPL0 20,63mm	FIAT	UNO		1991/1994	P/ CILINDRO BENDIX 2260511S
C-1122	REPARO DO CILINDRO MESTRE DUPL0 22,22mm	GM - CHEVROLET	OMEGA		1993/1998	4 CIL. S/ABS SIST. ATE
C-1122	REPARO DO CILINDRO MESTRE DUPL0 22,22mm	GM - CHEVROLET	SUPREMA		1993/1997	4 CIL. S/ABS SIST. ATE
C-1123	REPARO DO CILINDRO MESTRE DUPL0 22,22mm	GM - CHEVROLET	OMEGA		1993/1998	4 CIL. C/ABS
C-1123	REPARO DO CILINDRO MESTRE DUPL0 22,22mm	GM - CHEVROLET	SUPREMA		1993/1997	4 CIL. C/ABS
C-1124	REPARO DO CILINDRO MESTRE DUPL0 23,81mm	GM - CHEVROLET	OMEGA		1993/1998	6 CIL. C/ABS E S/ABS
C-1124	REPARO DO CILINDRO MESTRE DUPL0 23,81mm	GM - CHEVROLET	SUPREMA		1993/1997	6 CIL. C/ABS E S/ABS
C-1125	REPARO DO CILINDRO MESTRE DUPL0 28,57mm	FORD	F-1000		1992/1998	
C-1125	REPARO DO CILINDRO MESTRE DUPL0 28,57mm	FORD - CAMINHÕES	F-4000		1992/1998	SIST. BOSCH
C-1125	REPARO DO CILINDRO MESTRE DUPL0 28,57mm	GM - CHEVROLET	A-20		1993/1996	
C-1125	REPARO DO CILINDRO MESTRE DUPL0 28,57mm	GM - CHEVROLET	BONANZA		1993/1996	
C-1125	REPARO DO CILINDRO MESTRE DUPL0 28,57mm	GM - CHEVROLET	C-20		1993/1996	
C-1125	REPARO DO CILINDRO MESTRE DUPL0 28,57mm	GM - CHEVROLET	D-20		1993/1996	
C-1125	REPARO DO CILINDRO MESTRE DUPL0 28,57mm	GM - CHEVROLET	VERANEIO		1993/1996	
C-1127	REPARO DO CILINDRO MESTRE DUPL0 23,81mm	FORD	ESCORT		1993/1996	SIST. VARGA

Tabela de Conversão	Polegadas	9/16"	5/8"	11/16"	7/10"	3/4"	13/16"	7/8"	15/16"	1"	1 1/16"	1 1/8"	1 1/4"	1 3/8"	1 1/2"	1 5/8"	1 3/4"	1 27/32"	2"
	Milímetros		14,28mm	15,87mm	17,46mm	17,78mm	19,05mm	20,63mm	22,22mm	23,81mm	25,40mm	26,98mm	28,57mm	31,75mm	34,92mm	38,10mm	41,27mm	44,45mm	46,83mm

PEÇA	DESCRIÇÃO	MARCA	VEÍCULO		ANOS	SOMENTE PARA
C-1127	REPARO DO CILINDRO MESTRE DUPLO 23,81mm	FORD	VERONA		1994/1996	SIST. VARGA
C-1127	REPARO DO CILINDRO MESTRE DUPLO 23,81mm	VOLKSWAGEN	LOGUS		1993/1996	SIST. VARGA
C-1127	REPARO DO CILINDRO MESTRE DUPLO 23,81mm	VOLKSWAGEN	POINTER		1994/1996	SIST. VARGA
C-1128	REPARO DO CILINDRO MESTRE DUPLO 23,81mm	FORD	ESCORT		1993/2003	SIST. BOSCH
C-1128	REPARO DO CILINDRO MESTRE DUPLO 23,81mm	FORD	ESCORT SW		1997/2003	
C-1128	REPARO DO CILINDRO MESTRE DUPLO 23,81mm	FORD	VERONA		1994/1996	SIST. BOSCH
C-1128	REPARO DO CILINDRO MESTRE DUPLO 23,81mm	VOLKSWAGEN	LOGUS		1993/1996	SIST. BOSCH
C-1128	REPARO DO CILINDRO MESTRE DUPLO 23,81mm	VOLKSWAGEN	POINTER		1994/1996	SIST. BOSCH
C-1129	REPARO DO CILINDRO MESTRE DUPLO 20,63mm	GM - CHEVROLET	CORSA		1994/1995	SIST. DELCO S/ABS
C-1129	REPARO DO CILINDRO MESTRE DUPLO 20,63mm	GM - CHEVROLET	CORSA PICK-UP		1995/1998	SIST. DELCO S/ABS
C-1129	REPARO DO CILINDRO MESTRE DUPLO 20,63mm	GM - CHEVROLET	TIGRA		1998/1999	S/ABS
C-1130	REPARO DO CILINDRO MESTRE DUPLO 22,22mm	ALFA ROMEO	145		1996/1999	P/ CIL. BENDIX
C-1130	REPARO DO CILINDRO MESTRE DUPLO 22,22mm	ALFA ROMEO	155		1995/1998	P/ CIL. BENDIX
C-1130	REPARO DO CILINDRO MESTRE DUPLO 22,22mm	ALFA ROMEO	SPIDER		1996/1998	P/ CIL. BENDIX
C-1130	REPARO DO CILINDRO MESTRE DUPLO 22,22mm	FIAT	BRAVA		2000/2002	MOTOR 1.6 16V C/ CIL. BENDIX
C-1130	REPARO DO CILINDRO MESTRE DUPLO 22,22mm	FIAT	COUPÉ		1995/1997	P/ CIL. BENDIX
C-1130	REPARO DO CILINDRO MESTRE DUPLO 22,22mm	FIAT	TEMPRA SW		1994/1997	P/ CIL. BENDIX
C-1130	REPARO DO CILINDRO MESTRE DUPLO 22,22mm	FIAT	TIPO		1993/1997	P/ CIL. BENDIX
C-1131	REPARO DO CILINDRO MESTRE DUPLO 22,22mm	FIAT	TEMPRA		1993/1999	MOTOR 2.0 16V C/ABS
C-1131	REPARO DO CILINDRO MESTRE DUPLO 22,22mm	FIAT	TEMPRA		1995/1998	MOTOR 2.0 TURBO C/ CIL. BENDIX
C-1131	REPARO DO CILINDRO MESTRE DUPLO 22,22mm	FORD	ROYALE		1992/1996	C/ABS
C-1131	REPARO DO CILINDRO MESTRE DUPLO 22,22mm	FORD	VERSAILLES		1992/1996	C/ABS
C-1131	REPARO DO CILINDRO MESTRE DUPLO 22,22mm	VOLKSWAGEN	GOL (G2)		1995/2000	C/ABS
C-1131	REPARO DO CILINDRO MESTRE DUPLO 22,22mm	VOLKSWAGEN	GOL (G3)		2000/2004	MOTOR 1.0 TURBO
C-1131	REPARO DO CILINDRO MESTRE DUPLO 22,22mm	VOLKSWAGEN	GOL (G3)		2000/2005	C/ABS
C-1131	REPARO DO CILINDRO MESTRE DUPLO 22,22mm	VOLKSWAGEN	PARATI (G2, G3 e G4)		1996/2012	C/ABS
C-1131	REPARO DO CILINDRO MESTRE DUPLO 22,22mm	VOLKSWAGEN	PARATI (G2, G3 e G4)		2000/2004	MOTOR 1.0 TURBO
C-1131	REPARO DO CILINDRO MESTRE DUPLO 22,22mm	VOLKSWAGEN	QUANTUM		1992/2002	C/ABS
C-1131	REPARO DO CILINDRO MESTRE DUPLO 22,22mm	VOLKSWAGEN	SANTANA		1992/2006	C/ABS
C-1131	REPARO DO CILINDRO MESTRE DUPLO 22,22mm	VOLKSWAGEN	SAVEIRO (G2, G3 e G4)		1999/2009	C/ABS
C-1132	REPARO DO CILINDRO MESTRE DUPLO 20,63mm	FIAT	DUNA		1994/1996	SIST. ATE - REPOSIÇÃO
C-1132	REPARO DO CILINDRO MESTRE DUPLO 20,63mm	FIAT	ELBA		1991/1996	SIST. ATE - REPOSIÇÃO
C-1132	REPARO DO CILINDRO MESTRE DUPLO 20,63mm	FIAT	FIORINO (mod. Uno)		1991/1993	SIST. ATE - REPOSIÇÃO
C-1132	REPARO DO CILINDRO MESTRE DUPLO 20,63mm	FIAT	PALIO		1996/1998	S/ABS
C-1132	REPARO DO CILINDRO MESTRE DUPLO 20,63mm	FIAT	PALIO WEEKEND		1997/1998	MOTOR 1.5 S/ABS
C-1132	REPARO DO CILINDRO MESTRE DUPLO 20,63mm	FIAT	PRÊMIO		1991/1996	SIST. ATE - REPOSIÇÃO
C-1132	REPARO DO CILINDRO MESTRE DUPLO 20,63mm	FIAT	SIENA		1998/1998	S/ABS
C-1132	REPARO DO CILINDRO MESTRE DUPLO 20,63mm	FIAT	UNO		1987/1991	MOD. 1.5R/1.6R - REPOSIÇÃO
C-1132	REPARO DO CILINDRO MESTRE DUPLO 20,63mm	FIAT	UNO		1991/2001	SIST. ATE - REPOSIÇÃO
C-1132	REPARO DO CILINDRO MESTRE DUPLO 20,63mm	FIAT	UNO		2001/2010	SIST. ATE
C-1132	REPARO DO CILINDRO MESTRE DUPLO 20,63mm	FIAT	UNO		2011/...	MILLE/FURGÃO
C-1132	REPARO DO CILINDRO MESTRE DUPLO 20,63mm	GM - CHEVROLET	CORSA		1994/1998	P/ CILINDRO ATE 5825
C-1132	REPARO DO CILINDRO MESTRE DUPLO 20,63mm	GM - CHEVROLET	CORSA PICK-UP		1995/1998	P/ CILINDRO ATE 5825
C-1133	REPARO DO CILINDRO MESTRE DUPLO 25,40mm	GM - CHEVROLET	BLAZER		1996/2011	S/ABS
C-1133	REPARO DO CILINDRO MESTRE DUPLO 25,40mm	GM - CHEVROLET	BLAZER		1996/2011	C/ABS NAS RODAS TRASEIRAS
C-1133	REPARO DO CILINDRO MESTRE DUPLO 25,40mm	GM - CHEVROLET	S-10		1995/2012	S/ABS
C-1133	REPARO DO CILINDRO MESTRE DUPLO 25,40mm	GM - CHEVROLET	S-10		1995/2012	C/ABS NAS RODAS TRASEIRAS
C-1133	REPARO DO CILINDRO MESTRE DUPLO 25,40mm	TROLLER	T4		2002/...	
C-1134	REPARO DO CILINDRO MESTRE DUPLO 22,22mm	GM - CHEVROLET	OMEGA		1993/1998	4 CIL. S/ABS SIST. VARGA
C-1134	REPARO DO CILINDRO MESTRE DUPLO 22,22mm	GM - CHEVROLET	SUPREMA		1993/1997	4 CIL. S/ABS SIST. VARGA
C-1137	REPARO DO CILINDRO MESTRE DUPLO 22,22mm	FORD	ROYALE		1995/1996	S/ABS
C-1137	REPARO DO CILINDRO MESTRE DUPLO 22,22mm	FORD	VERSAILLES		1995/1996	S/ABS
C-1137	REPARO DO CILINDRO MESTRE DUPLO 22,22mm	TROLLER	T4		1997/2001	
C-1137	REPARO DO CILINDRO MESTRE DUPLO 22,22mm	VOLKSWAGEN	QUANTUM		1995/2002	S/ABS
C-1137	REPARO DO CILINDRO MESTRE DUPLO 22,22mm	VOLKSWAGEN	SANTANA		1995/2006	S/ABS
C-1138	REPARO DO CILINDRO MESTRE DUPLO 20,63mm	FORD	FIESTA		1995/1995	
C-1139	REPARO DO CILINDRO MESTRE DUPLO 22,22mm	GM - CHEVROLET	VECTRA		1997/2001	MOTOR 2.0/2.2 8V/C/ CILINDRO DELCO
C-1140	REPARO DO CILINDRO MESTRE DUPLO 22,22mm	GM - CHEVROLET	ASTRA		1995/1996	SIST. ATE
C-1140	REPARO DO CILINDRO MESTRE DUPLO 22,22mm	GM - CHEVROLET	VECTRA		1994/1996	SIST. ATE S/ABS
C-1141	REPARO DO CILINDRO MESTRE DUPLO 22,22mm	DAEWOO	ESPERO		1993/1998	C/ABS E S/ABS
C-1141	REPARO DO CILINDRO MESTRE DUPLO 22,22mm	GM - CHEVROLET	VECTRA		1994/1996	SIST. DELCO CÔNCAVO S/ABS
C-1142	REPARO DO CILINDRO MESTRE DUPLO 20,63mm	FIAT	DUNA		1994/1996	SIST. BOSCH

Tabela de Conversão	Polegadas	9/16"	5/8"	11/16"	7/10"	3/4"	13/16"	7/8"	15/16"	1"	1 1/16"	1 1/8"	1 1/4"	1 3/8"	1 1/2"	1 5/8"	1 3/4"	1 27/32"	2"
	Milímetros	14,28mm	15,87mm	17,46mm	17,78mm	19,05mm	20,63mm	22,22mm	23,81mm	25,40mm	26,98mm	28,57mm	31,75mm	34,92mm	38,10mm	41,27mm	44,45mm	46,83mm	50,80mm

PEÇA	DESCRIÇÃO	MARCA	VEÍCULO		ANOS	SOMENTE PARA
C-1142	REPARO DO CILINDRO MESTRE DUPL0 20,63mm	FIAT	ELBA		1991/1996	SIST. BOSCH
C-1142	REPARO DO CILINDRO MESTRE DUPL0 20,63mm	FIAT	FIORINO (mod. Uno)		1991/1993	SIST. BOSCH
C-1142	REPARO DO CILINDRO MESTRE DUPL0 20,63mm	FIAT	PRÊMIO		1991/1996	SIST. BOSCH
C-1142	REPARO DO CILINDRO MESTRE DUPL0 20,63mm	FIAT	UNO		1991/2010	SIST. BOSCH
C-1143	REPARO DO CILINDRO MESTRE DUPL0 22,22mm	VOLKSWAGEN	GOL (G2)		1995/2000	MOTOR 2.0 8V/16V S/ABS
C-1143	REPARO DO CILINDRO MESTRE DUPL0 22,22mm	VOLKSWAGEN	GOL (G3)		2000/2000	MOTOR 2.0 8V/16V S/ABS
C-1143	REPARO DO CILINDRO MESTRE DUPL0 22,22mm	VOLKSWAGEN	GOL (G3)		2001/2005	S/ABS
C-1143	REPARO DO CILINDRO MESTRE DUPL0 22,22mm	VOLKSWAGEN	GOL (G4)		2006/...	
C-1143	REPARO DO CILINDRO MESTRE DUPL0 22,22mm	VOLKSWAGEN	PARATI (G2, G3 e G4)		1996/2012	S/ABS
C-1143	REPARO DO CILINDRO MESTRE DUPL0 22,22mm	VOLKSWAGEN	SAVEIRO (G2, G3 e G4)		1998/2009	S/ABS
C-1144	REPARO DO CILINDRO MESTRE DUPL0 22,22mm	FORD	ROYALE		1995/1996	P/ CILINDRO BOSCH S/ABS
C-1144	REPARO DO CILINDRO MESTRE DUPL0 22,22mm	FORD	VERSAILLES		1995/1996	P/ CILINDRO BOSCH S/ABS
C-1144	REPARO DO CILINDRO MESTRE DUPL0 22,22mm	TROLLER	T4		1997/2001	P/ CILINDRO BOSCH
C-1144	REPARO DO CILINDRO MESTRE DUPL0 22,22mm	VOLKSWAGEN	QUANTUM		1995/2002	P/ CILINDRO BOSCH S/ABS
C-1144	REPARO DO CILINDRO MESTRE DUPL0 22,22mm	VOLKSWAGEN	SANTANA		1995/2006	P/ CILINDRO BOSCH S/ABS
C-1145	REPARO DO CILINDRO MESTRE DUPL0 22,22mm	FORD	FIESTA		1996/2002	MOTOR 1.0/1.3
C-1145	REPARO DO CILINDRO MESTRE DUPL0 22,22mm	FORD	FIESTA STREET HATCH		2001/2007	MOTOR 1.0
C-1145	REPARO DO CILINDRO MESTRE DUPL0 22,22mm	FORD	KA		2008/...	MOTOR 1.0
C-1146	REPARO DO CILINDRO MESTRE DUPL0 23,81mm	FORD	COURIER		1998/...	
C-1146	REPARO DO CILINDRO MESTRE DUPL0 23,81mm	FORD	FIESTA		1996/2002	MOTOR 1.4/1.6
C-1146	REPARO DO CILINDRO MESTRE DUPL0 23,81mm	FORD	FIESTA STREET HATCH		2002/2007	MOTOR 1.6
C-1146	REPARO DO CILINDRO MESTRE DUPL0 23,81mm	FORD	FIESTA STREET SEDAN		2002/2004	
C-1146	REPARO DO CILINDRO MESTRE DUPL0 23,81mm	FORD	KA		2008/...	MOTOR 1.6
C-1149	REPARO DO CILINDRO MESTRE DUPL0 22,22mm	ASIA	TOPIC		1993/1999	
C-1149	REPARO DO CILINDRO MESTRE DUPL0 22,22mm	KIA	BESTA		1993/1998	MOD. 2.2/2.7
C-1150	REPARO DO CILINDRO MESTRE DUPL0 20,63mm	FORD	KA		1997/2007	MOTOR 1.0/1.3
C-1151	REPARO DO CILINDRO MESTRE DUPL0 22,22mm	GM - CHEVROLET	VECTRA		1997/2001	MOTOR 2.0/2.2 8V
C-1152	REPARO DO CILINDRO MESTRE DUPL0 22,22mm	FIAT	FIORINO (mod. Uno)		1994/...	SIST. ATE
C-1152	REPARO DO CILINDRO MESTRE DUPL0 22,22mm	FIAT	PALIO		1998/...	SIST. ATE S/ABS
C-1152	REPARO DO CILINDRO MESTRE DUPL0 22,22mm	FIAT	PALIO WEEKEND		1997/1998	MOTOR 1.6 16V S/ABS
C-1152	REPARO DO CILINDRO MESTRE DUPL0 22,22mm	FIAT	PALIO WEEKEND		1998/...	SIST. ATE S/ABS
C-1152	REPARO DO CILINDRO MESTRE DUPL0 22,22mm	FIAT	SIENA		1998/...	SIST. ATE S/ABS
C-1152	REPARO DO CILINDRO MESTRE DUPL0 22,22mm	FIAT	STRADA		1999/...	SIST. ATE S/ABS
C-1154	REPARO DO CILINDRO MESTRE DUPL0 22,22mm	GM - CHEVROLET	ASTRA		1995/1996	SIST. DELCO
C-1154	REPARO DO CILINDRO MESTRE DUPL0 22,22mm	GM - CHEVROLET	VECTRA		1994/1996	SIST. DELCO CONVEXO S/ABS
C-1155	REPARO DO CILINDRO MESTRE DUPL0 23,81mm	MERCEDES BENZ	SPRINTER		1997/2000	MOD. 310
C-1156	REPARO DO CILINDRO MESTRE DUPL0 20,63mm	SEAT	CORDOBA		1995/1999	S/ABS C/CIL. ATE
C-1156	REPARO DO CILINDRO MESTRE DUPL0 20,63mm	SEAT	IBIZA		1995/1999	S/ABS C/CIL. ATE
C-1156	REPARO DO CILINDRO MESTRE DUPL0 20,63mm	VOLKSWAGEN	GOLF		1995/1998	MOD. GL C/CIL. ATE
C-1157	REPARO DO CILINDRO MESTRE DUPL0 31,75mm	FORD - CAMINHÕES	F-4000		1995/1998	SIST. VARGA
C-1158	REPARO DO CILINDRO MESTRE DUPL0 22,22mm	SEAT	CORDOBA		2000/2002	S/ABS C/CIL. ATE
C-1158	REPARO DO CILINDRO MESTRE DUPL0 22,22mm	SEAT	CORDOBA VARIO		2000/2002	S/ABS C/CIL. ATE
C-1158	REPARO DO CILINDRO MESTRE DUPL0 22,22mm	SEAT	IBIZA		2000/2002	S/ABS C/CIL. ATE
C-1158	REPARO DO CILINDRO MESTRE DUPL0 22,22mm	SEAT	INCA		1999/2002	C/CIL. ATE
C-1158	REPARO DO CILINDRO MESTRE DUPL0 22,22mm	VOLKSWAGEN	GOLF		1994/1998	MOD. GLX/GTI C/CIL. ATE S/ABS
C-1158	REPARO DO CILINDRO MESTRE DUPL0 22,22mm	VOLKSWAGEN	PASSAT		1991/1997	S/ABS C/CIL. ATE
C-1158	REPARO DO CILINDRO MESTRE DUPL0 22,22mm	VOLKSWAGEN	PASSAT VARIANT		1991/1997	S/ABS C/CIL. ATE
C-1158	REPARO DO CILINDRO MESTRE DUPL0 22,22mm	VOLKSWAGEN	POLO CLASSIC		1997/2002	S/ABS C/CIL. ATE
C-1158	REPARO DO CILINDRO MESTRE DUPL0 22,22mm	VOLKSWAGEN	VAN		1999/2002	C/CIL. ATE
C-1160	REPARO DO CILINDRO MESTRE DUPL0 22,22mm	GM - CHEVROLET	CALIBRA		1993/1995	SIST. ATE C/ABS
C-1160	REPARO DO CILINDRO MESTRE DUPL0 22,22mm	GM - CHEVROLET	VECTRA		1994/1996	SIST. ATE C/ABS
C-1161	REPARO DO CILINDRO MESTRE DUPL0 20,63mm	GM - CHEVROLET	AGILE		2010/2011	S/ABS
C-1161	REPARO DO CILINDRO MESTRE DUPL0 20,63mm	GM - CHEVROLET	CORSA		1998/2002	SIST. ATE
C-1161	REPARO DO CILINDRO MESTRE DUPL0 20,63mm	GM - CHEVROLET	CORSA CLASSIC		2003/2009	
C-1161	REPARO DO CILINDRO MESTRE DUPL0 20,63mm	GM - CHEVROLET	CORSA PICK-UP		1998/2003	SIST. ATE
C-1161	REPARO DO CILINDRO MESTRE DUPL0 20,63mm	GM - CHEVROLET	MONTANA		2011/2013	S/ABS
C-1163	REPARO DO CILINDRO MESTRE DUPL0 22,22mm	SEAT	CORDOBA		2000/2002	S/ABS C/CIL. BENDIX
C-1163	REPARO DO CILINDRO MESTRE DUPL0 22,22mm	SEAT	CORDOBA VARIO		2000/2002	S/ABS C/CIL. BENDIX
C-1163	REPARO DO CILINDRO MESTRE DUPL0 22,22mm	SEAT	IBIZA		2000/2002	S/ABS C/CIL. BENDIX
C-1163	REPARO DO CILINDRO MESTRE DUPL0 22,22mm	SEAT	INCA		1999/2002	C/CIL. BENDIX
C-1163	REPARO DO CILINDRO MESTRE DUPL0 22,22mm	VOLKSWAGEN	GOLF		1994/1998	MOD. GLX/GTI C/CIL. BENDIX S/ABS
C-1163	REPARO DO CILINDRO MESTRE DUPL0 22,22mm	VOLKSWAGEN	PASSAT		1991/1997	S/ABS C/CIL. BENDIX

Tabela de Conversão	Polegadas	9/16"	5/8"	11/16"	7/10"	3/4"	13/16"	7/8"	15/16"	1"	1 1/16"	1 1/8"	1 1/4"	1 3/8"	1 1/2"	1 5/8"	1 3/4"	1 27/32"	2"
	Milímetros		14,28mm	15,87mm	17,46mm	17,78mm	19,05mm	20,63mm	22,22mm	23,81mm	25,40mm	26,98mm	28,57mm	31,75mm	34,92mm	38,10mm	41,27mm	44,45mm	46,83mm

PEÇA	DESCRIÇÃO	MARCA	VEÍCULO		ANOS	SOMENTE PARA
C-1163	REPARO DO CILINDRO MESTRE DUPLO 22,22mm	VOLKSWAGEN	PASSAT VARIANT		1991/1997	S/ABS C/CIL. BENDIX
C-1163	REPARO DO CILINDRO MESTRE DUPLO 22,22mm	VOLKSWAGEN	POLO CLASSIC		1997/2002	S/ABS C/CIL. BENDIX
C-1163	REPARO DO CILINDRO MESTRE DUPLO 22,22mm	VOLKSWAGEN	VAN		1999/2002	C/CIL. BENDIX
C-1164	REPARO DO CILINDRO MESTRE DUPLO 23,81mm	GM - CHEVROLET	SPACE VAN		1997/1999	
C-1164	REPARO DO CILINDRO MESTRE DUPLO 23,81mm	GM - CHEVROLET	TRAFIC		1992/1998	
C-1164	REPARO DO CILINDRO MESTRE DUPLO 23,81mm	RENAULT	TRAFIC		1992/2003	
C-1165	REPARO DO CILINDRO MESTRE DUPLO 20,63mm	CITROËN	AX		1993/1996	MOD. 6TIC/ CIL. CONTROL
C-1165	REPARO DO CILINDRO MESTRE DUPLO 20,63mm	CITROËN	ZX		1992/1997	C/ CIL. CONTROL
C-1165	REPARO DO CILINDRO MESTRE DUPLO 20,63mm	PEUGEOT	106		1994/1996	C/ CIL. CONTROL
C-1165	REPARO DO CILINDRO MESTRE DUPLO 20,63mm	PEUGEOT	205		1992/1998	C/ CIL. CONTROL
C-1165	REPARO DO CILINDRO MESTRE DUPLO 20,63mm	RENAULT	19		1992/1998	C/ CIL. CONTROL/ VARGA
C-1165	REPARO DO CILINDRO MESTRE DUPLO 20,63mm	RENAULT	CLIO		1996/1999	C/ CIL. CONTROL/VARGA
C-1165	REPARO DO CILINDRO MESTRE DUPLO 20,63mm	RENAULT	EXPRESS		1998/2000	C/ CIL. CONTROL/ VARGA
C-1165	REPARO DO CILINDRO MESTRE DUPLO 20,63mm	RENAULT	MEGANE		1997/1999	C/ CIL. CONTROL S/ABS
C-1166	REPARO DO CILINDRO MESTRE DUPLO 20,63mm	PEUGEOT	405		1992/1999	P/ CILINDROS CONTROL E BENDIX
C-1167	REPARO DO CILINDRO MESTRE DUPLO 23,81mm	CITROËN	JUMPER		1996/2002	
C-1167	REPARO DO CILINDRO MESTRE DUPLO 23,81mm	FIAT	DUCATO		1998/1998	10/15 LUGARES
C-1167	REPARO DO CILINDRO MESTRE DUPLO 23,81mm	FIAT	DUCATO		1999/2000	15/COMBINATO/MINIBUS/MAXI S/TURBO
C-1167	REPARO DO CILINDRO MESTRE DUPLO 23,81mm	FIAT	DUCATO		2002/2002	MINIBUS S/INTERCOOLER
C-1167	REPARO DO CILINDRO MESTRE DUPLO 23,81mm	PEUGEOT	BOXER		1998/2002	
C-1168	REPARO DO CILINDRO MESTRE DUPLO 20,63mm	SEAT	CORDOBA		1995/1999	S/ABS C/CIL. BENDIX
C-1168	REPARO DO CILINDRO MESTRE DUPLO 20,63mm	SEAT	IBIZA		1995/1999	S/ABS C/CIL. BENDIX
C-1168	REPARO DO CILINDRO MESTRE DUPLO 20,63mm	VOLKSWAGEN	GOLF		1995/1998	MOD. GL C/CIL. BENDIX
C-1169	REPARO DO CILINDRO MESTRE DUPLO 20,63mm	VOLKSWAGEN	GOL (G2)		1995/2005	MOTOR 1.0/1.6/1.8 C/ CILINDRO BENDIX
C-1169	REPARO DO CILINDRO MESTRE DUPLO 20,63mm	VOLKSWAGEN	GOL (G3)		2000/2000	SIST. BOSCH C/MOTOR 1.0/1.6/1.8
C-1170	REPARO DO CILINDRO MESTRE DUPLO 20,63mm	GM - CHEVROLET	CELTA		2001/...	
C-1170	REPARO DO CILINDRO MESTRE DUPLO 20,63mm	GM - CHEVROLET	PRISMA		2007/2012	
C-1171	REPARO DO CILINDRO MESTRE DUPLO 22,22mm	GM - CHEVROLET	ASTRA		1999/2001	MOD. GL S/ABS
C-1171	REPARO DO CILINDRO MESTRE DUPLO 22,22mm	GM - CHEVROLET	ASTRA		2002/2011	S/ABS
C-1171	REPARO DO CILINDRO MESTRE DUPLO 22,22mm	GM - CHEVROLET	CORSA		2002/2012	S/ABS
C-1171	REPARO DO CILINDRO MESTRE DUPLO 22,22mm	GM - CHEVROLET	MONTANA		2004/2010	S/ABS
C-1172	REPARO DO CILINDRO MESTRE DUPLO 23,81mm	AUDI	A3		1997/2006	
C-1172	REPARO DO CILINDRO MESTRE DUPLO 23,81mm	AUDI	TT		1999/2006	
C-1172	REPARO DO CILINDRO MESTRE DUPLO 23,81mm	VOLKSWAGEN	BORA		2001/2007	
C-1172	REPARO DO CILINDRO MESTRE DUPLO 23,81mm	VOLKSWAGEN	GOLF		1999/...	
C-1172	REPARO DO CILINDRO MESTRE DUPLO 23,81mm	VOLKSWAGEN	NEW BEETLE		2000/2005	
C-1173	REPARO DO CILINDRO MESTRE DUPLO 23,81mm	TOYOTA	BANDEIRANTE		1995/2001	C/ <-
C-1174	REPARO DO CILINDRO MESTRE DUPLO 20,63mm	RENAULT	CLIO		2000/...	S/ABS C/CIL. EM FERRO
C-1174	REPARO DO CILINDRO MESTRE DUPLO 20,63mm	RENAULT	SYMBOL		2009/...	S/ABS
C-1175	REPARO DO CILINDRO MESTRE DUPLO 23,81mm	FORD	ECOSPORT		2003/2012	S/ABS
C-1175	REPARO DO CILINDRO MESTRE DUPLO 23,81mm	FORD	FIESTA		2003/...	MOTOR 1.6/1.0 SUPERCHARGER S/ABS
C-1175	REPARO DO CILINDRO MESTRE DUPLO 23,81mm	FORD	FIESTA SEDAN		2005/...	MOTOR 1.6/1.0 SUPERCHARGER S/ABS
C-1175	REPARO DO CILINDRO MESTRE DUPLO 23,81mm	FORD	FOCUS		2003/2009	SIST. ATE S/ABS
C-1175	REPARO DO CILINDRO MESTRE DUPLO 23,81mm	RENAULT	SCENIC		1999/2011	S/ABS
C-1175	REPARO DO CILINDRO MESTRE DUPLO 23,81mm	TROLLER	T4		2001/2002	
C-1180	REPARO DO CILINDRO MESTRE DUPLO 22,22mm	FIAT	DOBLÒ		2002/...	S/ABS
C-1201	REPARO DO HYDROVAC 10"	FORD - CAMINHÕES	F-11000		1980/1986	
C-1201	REPARO DO HYDROVAC 10"	GM - CAMINHÕES	C-60		1980/1984	C/ 2 EIXOS
C-1201	REPARO DO HYDROVAC 10"	GM - CAMINHÕES	D-60 (11000/12000)		1980/1996	C/ 2 EIXOS
C-1201	REPARO DO HYDROVAC 10"	VOLKSWAGEN - CAMINHÕES	Jun-80		1982/1986	
C-1201	REPARO DO HYDROVAC 10"	VOLKSWAGEN - CAMINHÕES	Jun-90		1982/1986	
C-1201	REPARO DO HYDROVAC 10"	VOLKSWAGEN - CAMINHÕES	Jul-90		1987/1994	
C-1201	REPARO DO HYDROVAC 10"	VOLKSWAGEN - CAMINHÕES	7-110 S		1988/1994	
C-1201	REPARO DO HYDROVAC 10"	VOLKSWAGEN - CAMINHÕES	11-130		1982/1985	
C-1202	REPARO PARCIAL DO HYDROVAC 10"	FORD - CAMINHÕES	F-11000		1980/1986	
C-1202	REPARO PARCIAL DO HYDROVAC 10"	GM - CAMINHÕES	C-60		1980/1984	C/ 2 EIXOS
C-1202	REPARO PARCIAL DO HYDROVAC 10"	GM - CAMINHÕES	D-60 (11000/12000)		1980/1996	C/ 2 EIXOS
C-1202	REPARO PARCIAL DO HYDROVAC 10"	VOLKSWAGEN - CAMINHÕES	Jun-80		1982/1986	
C-1202	REPARO PARCIAL DO HYDROVAC 10"	VOLKSWAGEN - CAMINHÕES	Jun-90		1982/1986	
C-1202	REPARO PARCIAL DO HYDROVAC 10"	VOLKSWAGEN - CAMINHÕES	Jul-90		1987/1994	
C-1202	REPARO PARCIAL DO HYDROVAC 10"	VOLKSWAGEN - CAMINHÕES	7-110 S		1988/1994	
C-1202	REPARO PARCIAL DO HYDROVAC 10"	VOLKSWAGEN - CAMINHÕES	11-130		1982/1985	

Tabela de Conversão	Polegadas	9/16"	5/8"	11/16"	7/10"	3/4"	13/16"	7/8"	15/16"	1"	1 1/16"	1 1/8"	1 1/4"	1 3/8"	1 1/2"	1 5/8"	1 3/4"	1 27/32"	2"
	Milímetros	14,28mm	15,87mm	17,46mm	17,78mm	19,05mm	20,63mm	22,22mm	23,81mm	25,40mm	26,98mm	28,57mm	31,75mm	34,92mm	38,10mm	41,27mm	44,45mm	46,83mm	50,80mm

PEÇA	DESCRIÇÃO	MARCA	VEÍCULO		ANOS	SOMENTE PARA
C-1209	REPARO DO HYDROVAC 91/2"	FORD - CAMINHÕES	F-4000		1983/1992	
C-1213	REPARO DO HYDROVAC 91/2"	CHRYSLER - CAMINHÕES	D-700		1970/1981	
C-1213	REPARO DO HYDROVAC 91/2"	CHRYSLER - CAMINHÕES	P-400		1979/1981	
C-1213	REPARO DO HYDROVAC 91/2"	FIAT - CAMINHÕES	70/80		1982/1985	
C-1213	REPARO DO HYDROVAC 91/2"	FORD - CAMINHÕES	F-350		1972/1975	
C-1213	REPARO DO HYDROVAC 91/2"	FORD - CAMINHÕES	F-400		1975/1977	
C-1213	REPARO DO HYDROVAC 91/2"	FORD - CAMINHÕES	F-600		1960/1980	
C-1213	REPARO DO HYDROVAC 91/2"	FORD - CAMINHÕES	F-4000		1975/1982	
C-1213	REPARO DO HYDROVAC 91/2"	FORD - CAMINHÕES	F-7000		1972/1980	
C-1213	REPARO DO HYDROVAC 91/2"	FORD - CAMINHÕES	F-11000		1980/1985	ESCRAVO
C-1213	REPARO DO HYDROVAC 91/2"	GM - CAMINHÕES	6500		1964/1971	
C-1213	REPARO DO HYDROVAC 91/2"	GM - CAMINHÕES	C-60		1964/1979	
C-1213	REPARO DO HYDROVAC 91/2"	GM - CAMINHÕES	C-60		1964/1981	ESCRAVO
C-1213	REPARO DO HYDROVAC 91/2"	GM - CAMINHÕES	D-60 (11000/12000)		1964/1979	
C-1213	REPARO DO HYDROVAC 91/2"	GM - CAMINHÕES	D-60 (11000/12000)		1964/1981	ESCRAVO
C-1213	REPARO DO HYDROVAC 91/2"	PUMA - CAMINHÕES	4T		1978/1984	
C-1216	REPARO DO HYDROVAC 10"	FORD - CAMINHÕES	F-11000		1986/1992	
C-1400	REPARO DO CILINDRO DE RODA 19,05mm	TOYOTA	COROLLA	->	1998/2002	
C-1401	REPARO DO CILINDRO DE RODA 34,92mm	GM - CAMINHÕES	C-60	<-	1980/1984	
C-1401	REPARO DO CILINDRO DE RODA 34,92mm	GM - CAMINHÕES	D-60 (11000/12000)	<-	1980/1996	
C-1401	REPARO DO CILINDRO DE RODA 34,92mm	GM - CAMINHÕES	D-80 (19000)	<-	1982/1984	
C-1401	REPARO DO CILINDRO DE RODA 34,92mm	VOLKSWAGEN - CAMINHÕES	11-130	<-	1982/1985	
C-1402	REPARO DO CILINDRO DE RODA 44,45mm	GM - CAMINHÕES	C-60	->	1980/1984	
C-1402	REPARO DO CILINDRO DE RODA 44,45mm	GM - CAMINHÕES	D-60 (11000/12000)	->	1980/1996	
C-1402	REPARO DO CILINDRO DE RODA 44,45mm	GM - CAMINHÕES	D-80 (19000)	->	1982/1984	
C-1404	REPARO DE VEDAÇÃO DA PINÇA 40,50mm	VOLKSWAGEN	FUSCA	<-	1970/1996	SIST. VARGA
C-1405	REPARO DO CILINDRO DE RODA 23,81mm	AGRALE	1100 D	->	1982/1983	
C-1405	REPARO DO CILINDRO DE RODA 23,81mm	AGRALE	1200 A	->	1983/1985	
C-1405	REPARO DO CILINDRO DE RODA 23,81mm	AGRALE	1600 A/D RS/RD	->	1990/1996	
C-1405	REPARO DO CILINDRO DE RODA 23,81mm	AGRALE	1800 D RS/RD	->	1988/1996	
C-1405	REPARO DO CILINDRO DE RODA 23,81mm	AGRALE	VOLARE A5/V5	->	2002/...	
C-1405	REPARO DO CILINDRO DE RODA 23,81mm	AGRALE	VOLARE A6/V6	->	1998/...	
C-1405	REPARO DO CILINDRO DE RODA 23,81mm	FORD	F-2000	->	1980/1987	
C-1405	REPARO DO CILINDRO DE RODA 23,81mm	FORD	GALAXIE	->	1967/1971	
C-1405	REPARO DO CILINDRO DE RODA 23,81mm	FORD - CAMINHÕES	F-4000	->	1985/1994	
C-1405	REPARO DO CILINDRO DE RODA 23,81mm	GM - CHEVROLET	A-20	->	1993/1996	
C-1405	REPARO DO CILINDRO DE RODA 23,81mm	GM - CHEVROLET	BLAZER	->	1996/2011	C/FREIO 280 X 63mm
C-1405	REPARO DO CILINDRO DE RODA 23,81mm	GM - CHEVROLET	BONANZA	->	1993/1996	
C-1405	REPARO DO CILINDRO DE RODA 23,81mm	GM - CHEVROLET	C-20	->	1993/1996	
C-1405	REPARO DO CILINDRO DE RODA 23,81mm	GM - CHEVROLET	D-20	->	1993/1996	
C-1405	REPARO DO CILINDRO DE RODA 23,81mm	GM - CHEVROLET	GRAND BLAZER	->	1998/1999	
C-1405	REPARO DO CILINDRO DE RODA 23,81mm	GM - CHEVROLET	S-10	->	1995/2012	C/FREIO 280 X 63mm
C-1405	REPARO DO CILINDRO DE RODA 23,81mm	GM - CHEVROLET	SILVERADO	->	1997/1999	
C-1405	REPARO DO CILINDRO DE RODA 23,81mm	GM - CHEVROLET	VERANEIO	->	1993/1996	
C-1405	REPARO DO CILINDRO DE RODA 23,81mm	GMC	3500 HD	->	1997/1999	
C-1407	REPARO DO CILINDRO DE RODA 22,22mm	FORD	AERO/ITAMARATY	->	1963/1971	
C-1407	REPARO DO CILINDRO DE RODA 22,22mm	FORD	F-100	->	1956/1987	
C-1407	REPARO DO CILINDRO DE RODA 22,22mm	FORD	GALAXIE	->	1971/1982	
C-1407	REPARO DO CILINDRO DE RODA 22,22mm	GM - CHEVROLET	A-10	->	1985/1989	
C-1407	REPARO DO CILINDRO DE RODA 22,22mm	GM - CHEVROLET	A-20	->	1985/1992	
C-1407	REPARO DO CILINDRO DE RODA 22,22mm	GM - CHEVROLET	BLAZER	->	1997/2011	C/FREIO 280 X 51mm
C-1407	REPARO DO CILINDRO DE RODA 22,22mm	GM - CHEVROLET	BONANZA	->	1990/1992	
C-1407	REPARO DO CILINDRO DE RODA 22,22mm	GM - CHEVROLET	C-10/14/15/16	->	1979/1989	
C-1407	REPARO DO CILINDRO DE RODA 22,22mm	GM - CHEVROLET	C-20	->	1985/1992	
C-1407	REPARO DO CILINDRO DE RODA 22,22mm	GM - CHEVROLET	S-10	->	1997/2012	C/FREIO 280 X 51mm
C-1407	REPARO DO CILINDRO DE RODA 22,22mm	GM - CAMINHÕES	6500	<-	1956/1971	
C-1407	REPARO DO CILINDRO DE RODA 22,22mm	GM - CAMINHÕES	C-60	<-	1964/1977	
C-1407	REPARO DO CILINDRO DE RODA 22,22mm	GM - CAMINHÕES	D-60 (11000/12000)	<-	1964/1977	
C-1408	REPARO DO CILINDRO DE RODA 28,57mm	CHRYSLER - CAMINHÕES	D-400	<-	1970/1978	
C-1408	REPARO DO CILINDRO DE RODA 28,57mm	FORD	F-100	<-	1956/1982	
C-1408	REPARO DO CILINDRO DE RODA 28,57mm	FORD - CAMINHÕES	F-350	<-	1956/1971	
C-1408	REPARO DO CILINDRO DE RODA 28,57mm	PUMA - CAMINHÕES	4T	<-	1978/1984	

Tabela de Conversão	Polegadas	9/16"	5/8"	11/16"	7/10"	3/4"	13/16"	7/8"	15/16"	1"	1 1/16"	1 1/8"	1 1/4"	1 3/8"	1 1/2"	1 5/8"	1 3/4"	1 27/32"	2"
	Milímetros	14,28mm	15,87mm	17,46mm	17,78mm	19,05mm	20,63mm	22,22mm	23,81mm	25,40mm	26,98mm	28,57mm	31,75mm	34,92mm	38,10mm	41,27mm	44,45mm	46,83mm	50,80mm



PEÇA	DESCRIÇÃO	MARCA	VEÍCULO		ANOS	SOMENTE PARA
C-1410	REPARO DO CILINDRO DE RODA 20,63mm	FORD	RANGER	->	1998/2001	C/ FREIO 10"
C-1411	REPARO DO CILINDRO DE RODA 20,63mm	KIA	SPORTAGE	->	1997/2004	
C-1412	REPARO DO CILINDRO DE RODA 31,75mm	CHRYSLER - CAMINHÕES	D-400	->	1970/1978	
C-1412	REPARO DO CILINDRO DE RODA 31,75mm	CHRYSLER - CAMINHÕES	P-400	->	1978/1981	
C-1412	REPARO DO CILINDRO DE RODA 31,75mm	FORD - CAMINHÕES	F-350	->	1956/1975	
C-1412	REPARO DO CILINDRO DE RODA 31,75mm	FORD - CAMINHÕES	F-400	->	1975/1977	
C-1412	REPARO DO CILINDRO DE RODA 31,75mm	FORD - CAMINHÕES	F-4000	->	1975/1984	
C-1412	REPARO DO CILINDRO DE RODA 31,75mm	FORD - CAMINHÕES	F-4000	->	2005/2012	
C-1412	REPARO DO CILINDRO DE RODA 31,75mm	GM - CAMINHÕES	D-40	->	1985/1997	
C-1412	REPARO DO CILINDRO DE RODA 31,75mm	GMC	6-100	->	1998/2002	
C-1412	REPARO DO CILINDRO DE RODA 31,75mm	GMC	6-150	->	1998/2002	
C-1412	REPARO DO CILINDRO DE RODA 31,75mm	PUMA - CAMINHÕES	4T	->	1978/1984	
C-1413	REPARO DE VEDAÇÃO DA PINÇA 48,00mm	FORD	BELINA II	<-	1983/1991	SIST. VARGA
C-1413	REPARO DE VEDAÇÃO DA PINÇA 48,00mm	FORD	DEL REY	<-	1983/1991	SIST. VARGA
C-1413	REPARO DE VEDAÇÃO DA PINÇA 48,00mm	FORD	PAMPA	<-	1983/1997	SIST. VARGA
C-1413	REPARO DE VEDAÇÃO DA PINÇA 48,00mm	GM - CHEVROLET	MONZA	<-	1981/1987	
C-1413	REPARO DE VEDAÇÃO DA PINÇA 48,00mm	RENAULT	CLIO	<-	2000/...	SIST. VARGA
C-1413	REPARO DE VEDAÇÃO DA PINÇA 48,00mm	RENAULT	SYMBOL	<-	2009/...	
C-1415	REPARO DO CILINDRO DE RODA 19,05mm	GM - CHEVROLET	MONZA	->	1981/1987	
C-1415	REPARO DO CILINDRO DE RODA 19,05mm	GURGEL	BR-800/SUPERMINI	->	1989/1993	
C-1416	REPARO DO CILINDRO DE RODA 25,40mm	FORD	AERO/ITAMARATY	->	1961/1962	
C-1416	REPARO DO CILINDRO DE RODA 25,40mm	FORD	F-75	->	1960/1982	
C-1416	REPARO DO CILINDRO DE RODA 25,40mm	FORD	F-1000	->	1979/1998	
C-1416	REPARO DO CILINDRO DE RODA 25,40mm	FORD - CAMINHÕES	F-4000	->	1995/1998	
C-1416	REPARO DO CILINDRO DE RODA 25,40mm	FORD - CAMINHÕES	F-4000	->	2002/2005	
C-1416	REPARO DO CILINDRO DE RODA 25,40mm	GM - CHEVROLET	3100	->	1956/1967	
C-1416	REPARO DO CILINDRO DE RODA 25,40mm	GM - CHEVROLET	C-10/14/15/16	->	1968/1978	
C-1416	REPARO DO CILINDRO DE RODA 25,40mm	GM - CHEVROLET	D-10	->	1979/1984	
C-1416	REPARO DO CILINDRO DE RODA 25,40mm	GM - CHEVROLET	D-20	->	1985/1992	
C-1416	REPARO DO CILINDRO DE RODA 25,40mm	GM - CHEVROLET	VERANEIO	->	1968/1992	
C-1416	REPARO DO CILINDRO DE RODA 25,40mm	GM - CAMINHÕES	C-60	<-	1978/1979	
C-1416	REPARO DO CILINDRO DE RODA 25,40mm	GM - CAMINHÕES	D-60 (11000/12000)	<-	1978/1979	
C-1417	REPARO DO CILINDRO DE RODA 25,40mm	TOYOTA	BANDEIRANTE	<-	1980/1996	
C-1418	REPARO DO CILINDRO DE RODA 22,22mm	TOYOTA	BANDEIRANTE	->	1980/1996	C/ <-
C-1419	REPARO DE VEDAÇÃO DA PINÇA 54,00mm	ALFA ROMEO	145	<-	1996/1999	SIST. ATE
C-1419	REPARO DE VEDAÇÃO DA PINÇA 54,00mm	FIAT	DOBLÒ	<-	2002/...	
C-1419	REPARO DE VEDAÇÃO DA PINÇA 54,00mm	FIAT	FIORINO (mod. Uno)	<-	1994/...	
C-1419	REPARO DE VEDAÇÃO DA PINÇA 54,00mm	FIAT	IDEA	<-	2006/...	
C-1419	REPARO DE VEDAÇÃO DA PINÇA 54,00mm	FIAT	LINEA	<-	2007/...	
C-1419	REPARO DE VEDAÇÃO DA PINÇA 54,00mm	FIAT	PALIO	<-	1998/...	
C-1419	REPARO DE VEDAÇÃO DA PINÇA 54,00mm	FIAT	PALIO WEEKEND	<-	1997/1998	MOTOR 1.6 16V
C-1419	REPARO DE VEDAÇÃO DA PINÇA 54,00mm	FIAT	PALIO WEEKEND	<-	1998/...	
C-1419	REPARO DE VEDAÇÃO DA PINÇA 54,00mm	FIAT	PUNTO	<-	2008/...	
C-1419	REPARO DE VEDAÇÃO DA PINÇA 54,00mm	FIAT	SIENA	<-	1998/...	
C-1419	REPARO DE VEDAÇÃO DA PINÇA 54,00mm	FIAT	STRADA	<-	1999/...	
C-1419	REPARO DE VEDAÇÃO DA PINÇA 54,00mm	FIAT	TEMPRA	<-	1992/1999	
C-1419	REPARO DE VEDAÇÃO DA PINÇA 54,00mm	FIAT	TEMPRA SW	<-	1994/1997	SIST. ATE
C-1419	REPARO DE VEDAÇÃO DA PINÇA 54,00mm	FIAT	TIPO	<-	1993/1995	MOTOR 2.0 8V/16V
C-1419	REPARO DE VEDAÇÃO DA PINÇA 54,00mm	FIAT	TIPO	<-	1996/1997	MOTOR 1.6 mpi
C-1419	REPARO DE VEDAÇÃO DA PINÇA 54,00mm	FIAT	UNO TURBO	<-	1994/1996	
C-1419	REPARO DE VEDAÇÃO DA PINÇA 54,00mm	FORD	COURIER	<-	1998/...	
C-1419	REPARO DE VEDAÇÃO DA PINÇA 54,00mm	FORD	ECOSPORT	<-	2003/2012	
C-1419	REPARO DE VEDAÇÃO DA PINÇA 54,00mm	FORD	ESCORT	<-	1983/1996	SIST. ATE
C-1419	REPARO DE VEDAÇÃO DA PINÇA 54,00mm	FORD	ESCORT HOBBY	<-	1993/1996	
C-1419	REPARO DE VEDAÇÃO DA PINÇA 54,00mm	FORD	FIESTA	<-	1996/2002	MOTOR 1.4/1.6
C-1419	REPARO DE VEDAÇÃO DA PINÇA 54,00mm	FORD	FIESTA	<-	2003/...	MOTOR 1.6/1.0 SUPERCHARGER S/ABS
C-1419	REPARO DE VEDAÇÃO DA PINÇA 54,00mm	FORD	FIESTA SEDAN	<-	2005/...	
C-1419	REPARO DE VEDAÇÃO DA PINÇA 54,00mm	FORD	FIESTA STREET HATCH	<-	2002/2007	MOTOR 1.6
C-1419	REPARO DE VEDAÇÃO DA PINÇA 54,00mm	FORD	FIESTA STREET SEDAN	<-	2002/2004	
C-1419	REPARO DE VEDAÇÃO DA PINÇA 54,00mm	FORD	KA	<-	2008/...	MOTOR 1.6
C-1419	REPARO DE VEDAÇÃO DA PINÇA 54,00mm	FORD	ROYALE	<-	1995/1996	SIST. ATE
C-1419	REPARO DE VEDAÇÃO DA PINÇA 54,00mm	FORD	VERONA	<-	1990/1996	SIST. ATE

Tabela de Conversão	Polegadas	9/16"	5/8"	11/16"	7/10"	3/4"	13/16"	7/8"	15/16"	1"	1 1/16"	1 1/8"	1 1/4"	1 3/8"	1 1/2"	1 5/8"	1 3/4"	1 27/32"	2"
	Milímetros	14,28mm	15,87mm	17,46mm	17,78mm	19,05mm	20,63mm	22,22mm	23,81mm	25,40mm	26,98mm	28,57mm	31,75mm	34,92mm	38,10mm	41,27mm	44,45mm	46,83mm	50,80mm

PEÇA	DESCRIÇÃO	MARCA	VEÍCULO		ANOS	SOMENTE PARA
C-1419	REPARO DE VEDAÇÃO DA PINÇA 54,00mm	FORD	VERSAILLES	<<	1995/1996	SIST. ATE
C-1419	REPARO DE VEDAÇÃO DA PINÇA 54,00mm	GM - CHEVROLET	ASTRA	<<	1999/2011	MOTOR 1.8 8V S/ ABS C/DISCO 236mm
C-1419	REPARO DE VEDAÇÃO DA PINÇA 54,00mm	GM - CHEVROLET	MERIVA	<<	2003/2012	
C-1419	REPARO DE VEDAÇÃO DA PINÇA 54,00mm	GM - CHEVROLET	OMEGA	<<	1993/1998	MOTOR 4 CIL.
C-1419	REPARO DE VEDAÇÃO DA PINÇA 54,00mm	GM - CHEVROLET	SUPREMA	<<	1993/1997	MOTOR 4 CIL.
C-1419	REPARO DE VEDAÇÃO DA PINÇA 54,00mm	GM - CHEVROLET	VECTRA	<<	2002/2011	
C-1419	REPARO DE VEDAÇÃO DA PINÇA 54,00mm	GM - CHEVROLET	ZAFIRA	<<	2002/2012	MOTOR 1.8/2.0 8V S/ABS
C-1419	REPARO DE VEDAÇÃO DA PINÇA 54,00mm	PEUGEOT	504 PICK-UP	<<	1992/1999	SIST. ATE
C-1419	REPARO DE VEDAÇÃO DA PINÇA 54,00mm	VOLKSWAGEN	APOLLO	<<	1990/1992	
C-1419	REPARO DE VEDAÇÃO DA PINÇA 54,00mm	VOLKSWAGEN	GOL (G2)	<<	1995/2000	SIST. ATE C/MOTOR 2.0
C-1419	REPARO DE VEDAÇÃO DA PINÇA 54,00mm	VOLKSWAGEN	GOL (G2)	<<	1995/2000	SIST. ATE C/ABS
C-1419	REPARO DE VEDAÇÃO DA PINÇA 54,00mm	VOLKSWAGEN	GOL (G3)	<<	2000/2000	SIST. ATE C/ MOTOR 2.0
C-1419	REPARO DE VEDAÇÃO DA PINÇA 54,00mm	VOLKSWAGEN	GOL (G3)	<<	2000/2000	SIST. ATE C/ABS
C-1419	REPARO DE VEDAÇÃO DA PINÇA 54,00mm	VOLKSWAGEN	GOL (G3)	<<	2001/2005	SIST. ATE
C-1419	REPARO DE VEDAÇÃO DA PINÇA 54,00mm	VOLKSWAGEN	GOL (G4)	<<	2006/...	SIST. ATE
C-1419	REPARO DE VEDAÇÃO DA PINÇA 54,00mm	VOLKSWAGEN	LOGUS	<<	1993/1996	SIST. ATE
C-1419	REPARO DE VEDAÇÃO DA PINÇA 54,00mm	VOLKSWAGEN	PARATI (G2, G3 e G4)	<<	1996/2012	SIST. ATE
C-1419	REPARO DE VEDAÇÃO DA PINÇA 54,00mm	VOLKSWAGEN	POINTER	<<	1994/1996	SIST. ATE
C-1419	REPARO DE VEDAÇÃO DA PINÇA 54,00mm	VOLKSWAGEN	QUANTUM	<<	1995/2002	SIST. ATE
C-1419	REPARO DE VEDAÇÃO DA PINÇA 54,00mm	VOLKSWAGEN	SANTANA	<<	1995/2006	SIST. ATE
C-1419	REPARO DE VEDAÇÃO DA PINÇA 54,00mm	VOLKSWAGEN	SAVEIRO (G2, G3 e G4)	<<	1998/2009	SIST. ATE
C-1420	REPARO DO CILINDRO DE RODA 17,78mm	FORD	ESCORT	->	1983/1992	P/ CIL. VARGA RCCR 0094.5
C-1420	REPARO DO CILINDRO DE RODA 17,78mm	FORD	ESCORT HOBBY	->	1993/1996	P/ CIL. VARGA RCCR 0094.5
C-1420	REPARO DO CILINDRO DE RODA 17,78mm	FORD	VERONA	->	1990/1992	P/ CIL. VARGA RCCR 0094.5
C-1420	REPARO DO CILINDRO DE RODA 17,78mm	VOLKSWAGEN	APOLLO	->	1990/1992	P/ CIL. VARGA RCCR 0094.5
C-1421	REPARO DE VEDAÇÃO DA PINÇA 48,00mm	FIAT	147/SPAZIO	<<	1976/1987	SIST. BENDIX
C-1421	REPARO DE VEDAÇÃO DA PINÇA 48,00mm	FIAT	FIORINO (mod. 147)	<<	1978/1988	SIST. BENDIX
C-1421	REPARO DE VEDAÇÃO DA PINÇA 48,00mm	FIAT	OGGI	<<	1983/1985	SIST. BENDIX
C-1421	REPARO DE VEDAÇÃO DA PINÇA 48,00mm	FIAT	PANORAMA	<<	1980/1987	SIST. BENDIX
C-1421	REPARO DE VEDAÇÃO DA PINÇA 48,00mm	FORD	BELINA II	<<	1978/1989	SIST. BENDIX COIFA C/ ENCAIXE INTERNO
C-1421	REPARO DE VEDAÇÃO DA PINÇA 48,00mm	FORD	CORCEL II	<<	1978/1986	SIST. BENDIX COIFA C/ ENCAIXE INTERNO
C-1421	REPARO DE VEDAÇÃO DA PINÇA 48,00mm	FORD	DEL REY	<<	1981/1989	SIST. BENDIX COIFA C/ ENCAIXE INTERNO
C-1421	REPARO DE VEDAÇÃO DA PINÇA 48,00mm	FORD	PAMPA	<<	1982/1983	SIST. BENDIX COIFA C/ ENCAIXE INTERNO
C-1422	REPARO DO CILINDRO DE RODA 28,57mm	AGRALE	1100 D	<<	1982/1983	
C-1422	REPARO DO CILINDRO DE RODA 28,57mm	AGRALE	1200 A	<<	1983/1985	
C-1422	REPARO DO CILINDRO DE RODA 28,57mm	AGRALE	1600 A/D RS/RD	<<	1983/1989	
C-1422	REPARO DO CILINDRO DE RODA 28,57mm	AGRALE	1800 D RS/RD	<<	1988/1989	
C-1422	REPARO DO CILINDRO DE RODA 28,57mm	FORD	AERO/ITAMARATY	<<	1961/1971	
C-1422	REPARO DO CILINDRO DE RODA 28,57mm	FORD	F-75	<<	1960/1982	
C-1422	REPARO DO CILINDRO DE RODA 28,57mm	FORD	F-250	->	1999/2012	
C-1422	REPARO DO CILINDRO DE RODA 28,57mm	FORD	GALAXIE	<<	1967/1971	
C-1422	REPARO DO CILINDRO DE RODA 28,57mm	FORD - CAMINHÕES	F-350	<<	1972/1975	
C-1422	REPARO DO CILINDRO DE RODA 28,57mm	FORD - CAMINHÕES	F-350	->	1999/2012	
C-1422	REPARO DO CILINDRO DE RODA 28,57mm	FORD - CAMINHÕES	F-400	<<	1975/1977	
C-1422	REPARO DO CILINDRO DE RODA 28,57mm	FORD - CAMINHÕES	F-600	<<	1972/1980	
C-1422	REPARO DO CILINDRO DE RODA 28,57mm	FORD - CAMINHÕES	F-4000	<<	1975/1984	
C-1422	REPARO DO CILINDRO DE RODA 28,57mm	FORD - CAMINHÕES	F-7000	<<	1972/1980	
C-1422	REPARO DO CILINDRO DE RODA 28,57mm	FORD - CAMINHÕES	F-11000	<<	1980/1992	
C-1422	REPARO DO CILINDRO DE RODA 28,57mm	GM - CHEVROLET	3100	<<	1956/1967	
C-1422	REPARO DO CILINDRO DE RODA 28,57mm	GM - CHEVROLET	C-10/14/15/16	<<	1968/1978	
C-1422	REPARO DO CILINDRO DE RODA 28,57mm	GM - CHEVROLET	GRAND BLAZER	->	1999/2000	
C-1422	REPARO DO CILINDRO DE RODA 28,57mm	GM - CHEVROLET	SILVERADO	->	1999/2001	
C-1422	REPARO DO CILINDRO DE RODA 28,57mm	GM - CHEVROLET	VERANEIO	<<	1968/1978	
C-1422	REPARO DO CILINDRO DE RODA 28,57mm	GMC	3500 HD	->	1999/2002	
C-1423	REPARO DO CILINDRO DE RODA 38,10mm	GM - CAMINHÕES	6500	->	1956/1971	
C-1423	REPARO DO CILINDRO DE RODA 38,10mm	GM - CAMINHÕES	C-60	->	1964/1971	
C-1423	REPARO DO CILINDRO DE RODA 38,10mm	GM - CAMINHÕES	D-60 (11000/12000)	->	1964/1971	
C-1424	REPARO DO CILINDRO DE RODA 19,05mm	FIAT	147/SPAZIO	->	1976/1987	P/ CILINDRO BENDIX
C-1424	REPARO DO CILINDRO DE RODA 19,05mm	FIAT	FIORINO (mod. 147)	->	1978/1988	P/ CILINDRO BENDIX
C-1424	REPARO DO CILINDRO DE RODA 19,05mm	FIAT	OGGI	->	1983/1985	P/ CILINDRO BENDIX
C-1424	REPARO DO CILINDRO DE RODA 19,05mm	FIAT	PANORAMA	->	1980/1987	P/ CILINDRO BENDIX
C-1427	REPARO DO CILINDRO DE RODA 19,05mm	FIAT	147/SPAZIO	->	1976/1987	

Tabela de Conversão	Polegadas	9/16"	5/8"	11/16"	7/10"	3/4"	13/16"	7/8"	15/16"	1"	1 1/16"	1 1/8"	1 1/4"	1 3/8"	1 1/2"	1 5/8"	1 3/4"	1 27/32"	2"
	Milímetros		14,28mm	15,87mm	17,46mm	17,78mm	19,05mm	20,63mm	22,22mm	23,81mm	25,40mm	26,98mm	28,57mm	31,75mm	34,92mm	38,10mm	41,27mm	44,45mm	46,83mm

PEÇA	DESCRIÇÃO	MARCA	VEÍCULO		ANOS	SOMENTE PARA
C-1427	REPARO DO CILINDRO DE RODA 19,05mm	FIAT	ELBA	->	1986/1996	
C-1427	REPARO DO CILINDRO DE RODA 19,05mm	FIAT	FIORINO (mod. 147)	->	1978/1988	
C-1427	REPARO DO CILINDRO DE RODA 19,05mm	FIAT	FIORINO (mod. Uno)	->	1988/1993	
C-1427	REPARO DO CILINDRO DE RODA 19,05mm	FIAT	OGGI	->	1983/1985	
C-1427	REPARO DO CILINDRO DE RODA 19,05mm	FIAT	PANORAMA	->	1980/1987	
C-1427	REPARO DO CILINDRO DE RODA 19,05mm	FIAT	PRÊMIO	->	1985/1996	EXCETO DUNA
C-1427	REPARO DO CILINDRO DE RODA 19,05mm	FIAT	UNO	->	1984/2008	
C-1428	REPARO DO CILINDRO DE RODA AUTOAJ. 19,05mm	FIAT	DUNA	->	1994/1996	
C-1430	REPARO DE VEDAÇÃO DA PINÇA 54,00mm	GURGEL	G-15	<-	1982/1984	
C-1430	REPARO DE VEDAÇÃO DA PINÇA 54,00mm	GURGEL	G-800 CS/CD	<-	1983/1991	
C-1430	REPARO DE VEDAÇÃO DA PINÇA 54,00mm	GURGEL	X-15/CARAJÁS	<-	1985/1993	
C-1430	REPARO DE VEDAÇÃO DA PINÇA 54,00mm	VOLKSWAGEN	KOMBI	<-	1982/...	SIST. ATE
C-1432	REPARO DO CILINDRO DE RODA 38,10mm	VOLKSWAGEN - CAMINHÕES	11-130	->	1982/1985	
C-1433	REPARO DO CILINDRO DE RODA 38,10mm	VOLKSWAGEN - CAMINHÕES	Jun-80	<-	1982/1986	
C-1433	REPARO DO CILINDRO DE RODA 38,10mm	VOLKSWAGEN - CAMINHÕES	Jun-80	->	1982/1986	
C-1433	REPARO DO CILINDRO DE RODA 38,10mm	VOLKSWAGEN - CAMINHÕES	Jun-90	<-	1982/1986	
C-1433	REPARO DO CILINDRO DE RODA 38,10mm	VOLKSWAGEN - CAMINHÕES	Jun-90	->	1982/1986	
C-1433	REPARO DO CILINDRO DE RODA 38,10mm	VOLKSWAGEN - CAMINHÕES	Jul-90	<-	1987/1994	
C-1433	REPARO DO CILINDRO DE RODA 38,10mm	VOLKSWAGEN - CAMINHÕES	Jul-90	->	1987/1994	
C-1433	REPARO DO CILINDRO DE RODA 38,10mm	VOLKSWAGEN - CAMINHÕES	7-110 S	<-	1988/1994	
C-1433	REPARO DO CILINDRO DE RODA 38,10mm	VOLKSWAGEN - CAMINHÕES	7-110 S	->	1988/1994	
C-1434	REPARO DE VEDAÇÃO DA PINÇA 48,00mm	FIAT	147/SPAZIO	<-	1981/1987	SIST. ATE (2 RODAS)
C-1434	REPARO DE VEDAÇÃO DA PINÇA 48,00mm	FIAT	FIORINO (mod. 147)	<-	1981/1988	SIST. ATE (2 RODAS)
C-1434	REPARO DE VEDAÇÃO DA PINÇA 48,00mm	FIAT	OGGI	<-	1983/1985	SIST. ATE (2 RODAS)
C-1434	REPARO DE VEDAÇÃO DA PINÇA 48,00mm	FIAT	PANORAMA	<-	1981/1987	SIST. ATE (2 RODAS)
C-1434	REPARO DE VEDAÇÃO DA PINÇA 48,00mm	FIAT	UNO	<-	1986/1988	SIST. ATE / DISCO 227mm (2 RODAS)
C-1434	REPARO DE VEDAÇÃO DA PINÇA 48,00mm	FORD	BELINA II	<-	1981/1989	SIST. ATE (2 RODAS)
C-1434	REPARO DE VEDAÇÃO DA PINÇA 48,00mm	FORD	CORCEL II	<-	1981/1986	SIST. ATE (2 RODAS)
C-1434	REPARO DE VEDAÇÃO DA PINÇA 48,00mm	FORD	DEL REY	<-	1981/1989	SIST. ATE (2 RODAS)
C-1435	REPARO DO CILINDRO DE RODA 25,40mm	FORD	AERO/ITAMARATY	->	1961/1961	
C-1435	REPARO DO CILINDRO DE RODA 25,40mm	FORD	F-75	->	1960/1961	C/ FREIO ESTAC. NO CARDAN
C-1435	REPARO DO CILINDRO DE RODA 25,40mm	FORD	JEEP	<-	1942/1959	
C-1435	REPARO DO CILINDRO DE RODA 25,40mm	FORD	JEEP	->	1960/1983	
C-1435	REPARO DO CILINDRO DE RODA 25,40mm	FORD	RURAL	->	1960/1977	
C-1438	REPARO DO CILINDRO DE RODA 28,57mm	FORD	AERO/ITAMARATY	<-	1961/1961	
C-1438	REPARO DO CILINDRO DE RODA 28,57mm	FORD	JEEP	<-	1960/1983	
C-1438	REPARO DO CILINDRO DE RODA 28,57mm	FORD	RURAL	<-	1960/1977	
C-1439	REPARO DO CILINDRO DE RODA 22,22mm	FORD	BELINA II	->	1978/1979	P/ CILINDRO VARGA 7/8"
C-1439	REPARO DO CILINDRO DE RODA 22,22mm	GM - CHEVROLET	CARAVAN	->	1981/1992	SIST. VARGA
C-1439	REPARO DO CILINDRO DE RODA 22,22mm	GM - CHEVROLET	CHEVETTE	->	1987/1994	SIST. VARGA
C-1439	REPARO DO CILINDRO DE RODA 22,22mm	GM - CHEVROLET	CHEVY	->	1987/1995	SIST. VARGA
C-1439	REPARO DO CILINDRO DE RODA 22,22mm	GM - CHEVROLET	MARAJÓ	->	1987/1989	SIST. VARGA
C-1439	REPARO DO CILINDRO DE RODA 22,22mm	GM - CHEVROLET	OPALA	->	1981/1992	SIST. VARGA
C-1440	REPARO DO CILINDRO DE RODA 28,57mm	FIAT	DUCATO	->	1998/1998	8-Oct
C-1440	REPARO DO CILINDRO DE RODA 28,57mm	FIAT	DUCATO	->	1999/2002	MAXI
C-1441	REPARO DO CILINDRO DE RODA 19,05mm	FORD	BELINA	->	1969/1977	
C-1441	REPARO DO CILINDRO DE RODA 19,05mm	FORD	BELINA II	->	1978/1991	SIST. BENDIX
C-1441	REPARO DO CILINDRO DE RODA 19,05mm	FORD	CORCEL II	->	1978/1986	SIST. BENDIX
C-1441	REPARO DO CILINDRO DE RODA 19,05mm	FORD	DEL REY	->	1981/1991	SIST. BENDIX
C-1442	REPARO DO CILINDRO DE RODA 22,22mm	CHRYSLER	DODGE 1800	->	1976/1976	
C-1442	REPARO DO CILINDRO DE RODA 22,22mm	CHRYSLER	POLARA	->	1977/1981	
C-1442	REPARO DO CILINDRO DE RODA 22,22mm	FORD	BELINA II	->	1978/1979	P/ CILINDRO BENDIX 7/8"
C-1442	REPARO DO CILINDRO DE RODA 22,22mm	FORD	DEL REY	->	1983/1991	C/ CÂMBIO AUTOMÁTICO
C-1442	REPARO DO CILINDRO DE RODA 22,22mm	GM - CHEVROLET	CARAVAN	->	1981/1982	SIST. BENDIX
C-1442	REPARO DO CILINDRO DE RODA 22,22mm	GM - CHEVROLET	CHEVETTE	->	1987/1994	SIST. BOSCH
C-1442	REPARO DO CILINDRO DE RODA 22,22mm	GM - CHEVROLET	CHEVY	->	1987/1995	SIST. BOSCH
C-1442	REPARO DO CILINDRO DE RODA 22,22mm	GM - CHEVROLET	MARAJÓ	->	1987/1989	SIST. BOSCH
C-1442	REPARO DO CILINDRO DE RODA 22,22mm	GM - CHEVROLET	OPALA	->	1981/1982	SIST. BENDIX
C-1443	REPARO DE VEDAÇÃO DA PINÇA 48,00mm	CITROËN	XSARA	<-	1998/2003	SIST. ATE
C-1443	REPARO DE VEDAÇÃO DA PINÇA 48,00mm	DAEWOO	LANOS	<-	1997/2000	SIST. ATE C/ARO 13"
C-1443	REPARO DE VEDAÇÃO DA PINÇA 48,00mm	FIAT	DUNA	<-	1994/1996	SIST. ATE
C-1443	REPARO DE VEDAÇÃO DA PINÇA 48,00mm	FIAT	ELBA	<-	1986/1996	SIST. ATE

Tabela de Conversão	Polegadas	9/16"	5/8"	11/16"	7/10"	3/4"	13/16"	7/8"	15/16"	1"	1 1/16"	1 1/8"	1 1/4"	1 3/8"	1 1/2"	1 5/8"	1 3/4"	1 27/32"	2"
	Milímetros	14,28mm	15,87mm	17,46mm	17,78mm	19,05mm	20,63mm	22,22mm	23,81mm	25,40mm	26,98mm	28,57mm	31,75mm	34,92mm	38,10mm	41,27mm	44,45mm	46,83mm	50,80mm



PEÇA	DESCRIÇÃO	MARCA	VEÍCULO		ANOS	SOMENTE PARA
C-1443	REPARO DE VEDAÇÃO DA PINÇA 48,00mm	FIAT	FIORINO (mod. Uno)	<-	1988/1993	SIST. ATE
C-1443	REPARO DE VEDAÇÃO DA PINÇA 48,00mm	FIAT	PALIO	<-	1996/1998	
C-1443	REPARO DE VEDAÇÃO DA PINÇA 48,00mm	FIAT	PALIO WEEKEND	<-	1997/1998	MOTOR 1.5
C-1443	REPARO DE VEDAÇÃO DA PINÇA 48,00mm	FIAT	PRÊMIO	<-	1985/1996	SIST. ATE
C-1443	REPARO DE VEDAÇÃO DA PINÇA 48,00mm	FIAT	SIENA	<-	1998/1998	
C-1443	REPARO DE VEDAÇÃO DA PINÇA 48,00mm	FIAT	UNO	<-	1984/...	SIST. ATE C/ DISCO 240mm
C-1443	REPARO DE VEDAÇÃO DA PINÇA 48,00mm	FORD	FIESTA	<-	1995/2002	MOTOR 1.0/1.3
C-1443	REPARO DE VEDAÇÃO DA PINÇA 48,00mm	FORD	FIESTA	<-	2003/...	MOTOR 1.0
C-1443	REPARO DE VEDAÇÃO DA PINÇA 48,00mm	FORD	FIESTA STREET HATCH	<-	2001/2007	MOTOR 1.0
C-1443	REPARO DE VEDAÇÃO DA PINÇA 48,00mm	FORD	KA	<-	1997/2007	
C-1443	REPARO DE VEDAÇÃO DA PINÇA 48,00mm	FORD	KA	<-	2008/...	MOTOR 1.0
C-1443	REPARO DE VEDAÇÃO DA PINÇA 48,00mm	FORD	ROYALE	<-	1992/1994	
C-1443	REPARO DE VEDAÇÃO DA PINÇA 48,00mm	FORD	VERSAILLES	<-	1991/1994	
C-1443	REPARO DE VEDAÇÃO DA PINÇA 48,00mm	PEUGEOT	106	<-	1992/2001	SIST. ATE
C-1443	REPARO DE VEDAÇÃO DA PINÇA 48,00mm	PEUGEOT	205	<-	1992/1998	SIST. ATE
C-1443	REPARO DE VEDAÇÃO DA PINÇA 48,00mm	PEUGEOT	306	<-	1994/2002	SIST. ATE
C-1443	REPARO DE VEDAÇÃO DA PINÇA 48,00mm	SEAT	CORDOBA	<-	1995/1999	
C-1443	REPARO DE VEDAÇÃO DA PINÇA 48,00mm	SEAT	IBIZA	<-	1995/1999	
C-1443	REPARO DE VEDAÇÃO DA PINÇA 48,00mm	SEAT	IBIZA	<-	2000/2002	MOTOR 1.0
C-1443	REPARO DE VEDAÇÃO DA PINÇA 48,00mm	VOLKSWAGEN	GOL (G1)	<-	1984/1994	MOTOR 1.8/2.0
C-1443	REPARO DE VEDAÇÃO DA PINÇA 48,00mm	VOLKSWAGEN	GOL (G2)	<-	1995/2005	SIST. ATE C/MOTOR 1.0/1.6/1.8 S/ABS
C-1443	REPARO DE VEDAÇÃO DA PINÇA 48,00mm	VOLKSWAGEN	GOL (G3)	<-	2000/2000	SIST. ATE C/ MOTOR 1.0/1.6/1.8 S/ABS
C-1443	REPARO DE VEDAÇÃO DA PINÇA 48,00mm	VOLKSWAGEN	GOLF	<-	1996/1998	MOD. GL SIST. ATE (fabr. México)
C-1443	REPARO DE VEDAÇÃO DA PINÇA 48,00mm	VOLKSWAGEN	PARATI (G1)	<-	1987/1996	MOTOR 1.8
C-1443	REPARO DE VEDAÇÃO DA PINÇA 48,00mm	VOLKSWAGEN	PASSAT	<-	1985/1989	MOTOR 1.8
C-1443	REPARO DE VEDAÇÃO DA PINÇA 48,00mm	VOLKSWAGEN	QUANTUM	<-	1985/1994	
C-1443	REPARO DE VEDAÇÃO DA PINÇA 48,00mm	VOLKSWAGEN	SANTANA	<-	1984/1994	
C-1443	REPARO DE VEDAÇÃO DA PINÇA 48,00mm	VOLKSWAGEN	SAVEIRO (G1)	<-	1990/1997	MOTOR 1.8 SIST. ATE
C-1443	REPARO DE VEDAÇÃO DA PINÇA 48,00mm	VOLKSWAGEN	VOYAGE (G1)	<-	1987/1994	MOTOR 1.8
C-1445	REPARO DO CILINDRO DE RODA 23,81mm	GURGEL	G-15	->	1983/1984	
C-1445	REPARO DO CILINDRO DE RODA 23,81mm	GURGEL	G-800 CS/CD	->	1983/1991	
C-1445	REPARO DO CILINDRO DE RODA 23,81mm	GURGEL	X-15/CARAJÁS	->	1985/1993	
C-1445	REPARO DO CILINDRO DE RODA 23,81mm	VOLKSWAGEN	KOMBI	->	1982/...	
C-1446	REPARO DO CILINDRO DE RODA 17,46mm	FORD	ROYALE	->	1992/1996	
C-1446	REPARO DO CILINDRO DE RODA 17,46mm	FORD	VERSAILLES	->	1991/1994	C/ CÂMBIO AUTOMÁTICO
C-1446	REPARO DO CILINDRO DE RODA 17,46mm	FORD	VERSAILLES	->	1995/1996	
C-1446	REPARO DO CILINDRO DE RODA 17,46mm	VOLKSWAGEN	CROSSFOX	->	2005/...	
C-1446	REPARO DO CILINDRO DE RODA 17,46mm	VOLKSWAGEN	FOX	->	2004/...	
C-1446	REPARO DO CILINDRO DE RODA 17,46mm	VOLKSWAGEN	GOL (G2)	->	1995/1997	C/ABS
C-1446	REPARO DO CILINDRO DE RODA 17,46mm	VOLKSWAGEN	GOL (G2)	->	1995/2000	MOTOR 2.0 S/ABS
C-1446	REPARO DO CILINDRO DE RODA 17,46mm	VOLKSWAGEN	GOL (G3)	->	2000/2002	MOTOR 2.0 S/ABS
C-1446	REPARO DO CILINDRO DE RODA 17,46mm	VOLKSWAGEN	GOL (G3)	->	2000/2004	MOTOR 1.0 TURBO S/ABS
C-1446	REPARO DO CILINDRO DE RODA 17,46mm	VOLKSWAGEN	GOL (G5)	->	2009/...	C/ABS
C-1446	REPARO DO CILINDRO DE RODA 17,46mm	VOLKSWAGEN	GOLF	->	1996/1998	MOD. GL (fabr. México)
C-1446	REPARO DO CILINDRO DE RODA 17,46mm	VOLKSWAGEN	PARATI (G1)	->	1983/1996	
C-1446	REPARO DO CILINDRO DE RODA 17,46mm	VOLKSWAGEN	PARATI (G2, G3 e G4)	->	1996/1997	C/ABS
C-1446	REPARO DO CILINDRO DE RODA 17,46mm	VOLKSWAGEN	POLO	->	2002/...	
C-1446	REPARO DO CILINDRO DE RODA 17,46mm	VOLKSWAGEN	QUANTUM	->	1985/2002	
C-1446	REPARO DO CILINDRO DE RODA 17,46mm	VOLKSWAGEN	SANTANA	->	1984/1994	C/ CÂMBIO AUTOMÁTICO
C-1446	REPARO DO CILINDRO DE RODA 17,46mm	VOLKSWAGEN	SANTANA	->	1995/2006	
C-1446	REPARO DO CILINDRO DE RODA 17,46mm	VOLKSWAGEN	SAVEIRO (G1)	->	1987/1997	
C-1446	REPARO DO CILINDRO DE RODA 17,46mm	VOLKSWAGEN	VOYAGE (G5)	->	2009/...	
C-1447	REPARO DO CILINDRO DE RODA 19,05mm	SEAT	CORDOBA	->	1995/2002	
C-1447	REPARO DO CILINDRO DE RODA 19,05mm	SEAT	CORDOBA VARIO	->	2000/2002	
C-1447	REPARO DO CILINDRO DE RODA 19,05mm	SEAT	IBIZA	->	1995/2002	
C-1447	REPARO DO CILINDRO DE RODA 19,05mm	VOLKSWAGEN	GOL (G2)	->	1998/2000	C/ABS
C-1447	REPARO DO CILINDRO DE RODA 19,05mm	VOLKSWAGEN	GOL (G3)	->	2000/2005	C/ABS
C-1447	REPARO DO CILINDRO DE RODA 19,05mm	VOLKSWAGEN	GOLF	->	1995/1998	MOD. GLX
C-1447	REPARO DO CILINDRO DE RODA 19,05mm	VOLKSWAGEN	GOLF	->	1995/1998	MOD. GL (fabr. Alemanha)
C-1447	REPARO DO CILINDRO DE RODA 19,05mm	VOLKSWAGEN	PARATI (G2, G3 e G4)	->	1996/2000	S/ABS
C-1447	REPARO DO CILINDRO DE RODA 19,05mm	VOLKSWAGEN	PARATI (G2, G3 e G4)	->	1998/2012	C/ABS
C-1447	REPARO DO CILINDRO DE RODA 19,05mm	VOLKSWAGEN	POLO CLASSIC	->	1997/2002	

Tabela de Conversão	Polegadas	9/16"	5/8"	11/16"	7/10"	3/4"	13/16"	7/8"	15/16"	1"	1 1/16"	1 1/8"	1 1/4"	1 3/8"	1 1/2"	1 5/8"	1 3/4"	1 27/32"	2"
	Milímetros		14,28mm	15,87mm	17,46mm	17,78mm	19,05mm	20,63mm	22,22mm	23,81mm	25,40mm	26,98mm	28,57mm	31,75mm	34,92mm	38,10mm	41,27mm	44,45mm	46,83mm

PEÇA	DESCRIÇÃO	MARCA	VEÍCULO		ANOS	SOMENTE PARA
C-1447	REPARO DO CILINDRO DE RODA 19,05mm	VOLKSWAGEN	SAVEIRO (G1)	->	1982/1986	
C-1447	REPARO DO CILINDRO DE RODA 19,05mm	VOLKSWAGEN	SAVEIRO (G2, G3 e G4)	->	1998/1998	
C-1447	REPARO DO CILINDRO DE RODA 19,05mm	VOLKSWAGEN	SAVEIRO (G2, G3 e G4)	->	2000/2009	C/ABS
C-1447	REPARO DO CILINDRO DE RODA 19,05mm	VOLKSWAGEN	SAVEIRO (G5)	->	2010/...	1KN
C-1447	REPARO DO CILINDRO DE RODA 19,05mm	VOLKSWAGEN	SPACEFOX	->	2006/...	
C-1447	REPARO DO CILINDRO DE RODA 19,05mm	VOLKSWAGEN	SPACE CROSS	->	2012/...	
C-1448	REPARO DE VEDAÇÃO DA PINÇA 57,00mm	MITSUBISHI	L200	<-	1992/2006	L/GL/GLS
C-1448	REPARO DE VEDAÇÃO DA PINÇA 57,00mm	MITSUBISHI	L300	<-	1995/1999	
C-1449	REPARO DE VEDAÇÃO DA PINÇA 42,70mm	TOYOTA	HILUX PICK-UP	<-	1999/2005	SIST. VARGA
C-1452	REPARO DE VEDAÇÃO DA PINÇA 47,00mm	GM - CHEVROLET	BLAZER	<-	1996/2011	C/ TRAÇÃO 4X4
C-1452	REPARO DE VEDAÇÃO DA PINÇA 47,00mm	GM - CHEVROLET	S-10	<-	1996/2012	C/ TRAÇÃO 4X4
C-1453	REPARO DO CILINDRO DE RODA 41,27mm	MERCEDES BENZ - CAMINHÕES	L/LA/LK/LP/LS/O/OH-321	<-	1957/1965	
C-1453	REPARO DO CILINDRO DE RODA 41,27mm	MERCEDES BENZ - CAMINHÕES	L/LA/LS-1111	<-	1965/1970	
C-1453	REPARO DO CILINDRO DE RODA 41,27mm	MERCEDES BENZ - CAMINHÕES	L/LA/LK/LS/OF-1113	<-	1965/1983	MOD. L/LA/LK/LS
C-1453	REPARO DO CILINDRO DE RODA 41,27mm	MERCEDES BENZ - CAMINHÕES	L/LA/LK/LS/OF-1113	<-	1983/1989	MOD. LA/LK/LS
C-1454	REPARO DO CILINDRO DE RODA 44,45mm	MERCEDES BENZ - CAMINHÕES	L/LA/LK/LP/LS/O/OH-321	->	1965/1970	
C-1454	REPARO DO CILINDRO DE RODA 44,45mm	MERCEDES BENZ - CAMINHÕES	O-352	->	1965/1970	
C-1454	REPARO DO CILINDRO DE RODA 44,45mm	MERCEDES BENZ - CAMINHÕES	L/LA/LK/LS/OF-1113	->	1965/1989	
C-1454	REPARO DO CILINDRO DE RODA 44,45mm	MERCEDES BENZ - CAMINHÕES	L-1116	<-	1983/1989	
C-1454	REPARO DO CILINDRO DE RODA 44,45mm	MERCEDES BENZ - CAMINHÕES	L-2013	->	1974/1989	TERCEIRO EIXO
C-1454	REPARO DO CILINDRO DE RODA 44,45mm	MERCEDES BENZ - CAMINHÕES	L-2013	->	1977/1989	
C-1454	REPARO DO CILINDRO DE RODA 44,45mm	MERCEDES BENZ - CAMINHÕES	L/LB/LK-2213	->	1973/1990	
C-1455	REPARO DO CILINDRO DE RODA 25,40mm	TOYOTA	HILUX SW4	->	2000/2005	C/ ARO 16"
C-1464	REPARO DO CILINDRO DE RODA 46,83mm	MERCEDES BENZ - CAMINHÕES	O-352	<-	1970/1978	
C-1464	REPARO DO CILINDRO DE RODA 46,83mm	MERCEDES BENZ - CAMINHÕES	O/OH-362/362 A	<-	1978/1989	MOD. 0
C-1464	REPARO DO CILINDRO DE RODA 46,83mm	MERCEDES BENZ - CAMINHÕES	O-364	<-	1978/1989	
C-1464	REPARO DO CILINDRO DE RODA 46,83mm	MERCEDES BENZ - CAMINHÕES	L/LS/LK/OF/OH-1313	<-	1976/1989	
C-1464	REPARO DO CILINDRO DE RODA 46,83mm	MERCEDES BENZ - CAMINHÕES	L/OH-1316	<-	1970/1989	
C-1464	REPARO DO CILINDRO DE RODA 46,83mm	MERCEDES BENZ - CAMINHÕES	OH-1416	<-	1970/1989	
C-1464	REPARO DO CILINDRO DE RODA 46,83mm	MERCEDES BENZ - CAMINHÕES	L/LP/OH-1419	<-	1970/1989	
C-1464	REPARO DO CILINDRO DE RODA 46,83mm	MERCEDES BENZ - CAMINHÕES	L/LK-1513/1516	<-	1971/1989	
C-1464	REPARO DO CILINDRO DE RODA 46,83mm	MERCEDES BENZ - CAMINHÕES	OH-1517	<-	1970/1989	
C-1464	REPARO DO CILINDRO DE RODA 46,83mm	MERCEDES BENZ - CAMINHÕES	L-1519	<-	1973/1990	
C-1464	REPARO DO CILINDRO DE RODA 46,83mm	MERCEDES BENZ - CAMINHÕES	L-2013	<-	1973/1989	
C-1464	REPARO DO CILINDRO DE RODA 46,83mm	MERCEDES BENZ - CAMINHÕES	L/LB/LK-2213	<-	1973/1990	
C-1472	REPARO DO CILINDRO DE RODA 22,22mm	GURGEL	X-12/TOCANTINS	<-	1969/1977	P/ CILINDRO VARGA RCCR 2157.8
C-1472	REPARO DO CILINDRO DE RODA 22,22mm	VOLKSWAGEN	FUSCA	<-	1957/1976	P/ CILINDRO VARGA RCCR 2157.8
C-1472	REPARO DO CILINDRO DE RODA 22,22mm	VOLKSWAGEN	KARMANN GHIA	<-	1957/1969	P/ CILINDRO VARGA RCCR 2157.8
C-1473	REPARO DO CILINDRO DE RODA 19,05mm	PUMA	GT/GTE/GTS	->	1974/1976	
C-1473	REPARO DO CILINDRO DE RODA 19,05mm	VOLKSWAGEN	BRASILIA	->	1973/1976	P/ CILINDRO 3/4"
C-1473	REPARO DO CILINDRO DE RODA 19,05mm	VOLKSWAGEN	FUSCA	->	1957/1976	C/ EIXO 5 FUROS
C-1473	REPARO DO CILINDRO DE RODA 19,05mm	VOLKSWAGEN	FUSCA	->	1977/1996	
C-1473	REPARO DO CILINDRO DE RODA 19,05mm	VOLKSWAGEN	KARMANN GHIA	->	1957/1969	
C-1473	REPARO DO CILINDRO DE RODA 19,05mm	VOLKSWAGEN	KARMANN GHIA TC	->	1970/1972	P/ CILINDRO 3/4"
C-1473	REPARO DO CILINDRO DE RODA 19,05mm	VOLKSWAGEN	SEDAN 1600 4 PORTAS	->	1969/1971	P/ CILINDRO 3/4"
C-1473	REPARO DO CILINDRO DE RODA 19,05mm	VOLKSWAGEN	TL	->	1969/1972	P/ CILINDRO 3/4"
C-1473	REPARO DO CILINDRO DE RODA 19,05mm	VOLKSWAGEN	VARIANT	->	1970/1972	P/ CILINDRO 3/4"
C-1475	REPARO DO CILINDRO DE RODA 17,46mm	GURGEL	X-12/TOCANTINS	->	1969/1980	
C-1475	REPARO DO CILINDRO DE RODA 17,46mm	PUMA	GT/GTE/GTS	->	1968/1973	
C-1475	REPARO DO CILINDRO DE RODA 17,46mm	VOLKSWAGEN	FUSCA	->	1970/1976	C/ EIXO 4 FUROS
C-1476	REPARO DO CILINDRO DE RODA 22,22mm	GURGEL	E-400	->	1981/1983	
C-1476	REPARO DO CILINDRO DE RODA 22,22mm	GURGEL	X-20	->	1977/1979	
C-1476	REPARO DO CILINDRO DE RODA 22,22mm	VOLKSWAGEN	KOMBI	->	1957/1975	
C-1477	REPARO DO CILINDRO DE RODA 25,40mm	GURGEL	E-400	<-	1981/1983	
C-1477	REPARO DO CILINDRO DE RODA 25,40mm	GURGEL	G-15	<-	1980/1981	
C-1477	REPARO DO CILINDRO DE RODA 25,40mm	GURGEL	X-20	<-	1977/1979	
C-1477	REPARO DO CILINDRO DE RODA 25,40mm	VOLKSWAGEN	KOMBI	<-	1957/1982	
C-1478	REPARO DO CILINDRO DE RODA 50,80mm	MERCEDES BENZ - CAMINHÕES	O/OH-362/362 A	->	1978/1989	MOD. 0
C-1478	REPARO DO CILINDRO DE RODA 50,80mm	MERCEDES BENZ - CAMINHÕES	L/LS/LK/OF/OH-1313	->	1976/1989	
C-1478	REPARO DO CILINDRO DE RODA 50,80mm	MERCEDES BENZ - CAMINHÕES	L/OH-1316	->	1970/1989	
C-1478	REPARO DO CILINDRO DE RODA 50,80mm	MERCEDES BENZ - CAMINHÕES	L/LK-1513/1516	->	1971/1989	
C-1478	REPARO DO CILINDRO DE RODA 50,80mm	MERCEDES BENZ - CAMINHÕES	OH-1517	->	1970/1989	

Tabela de Conversão	Polegadas	9/16"	5/8"	11/16"	7/10"	3/4"	13/16"	7/8"	15/16"	1"	1 1/16"	1 1/8"	1 1/4"	1 3/8"	1 1/2"	1 5/8"	1 3/4"	1 27/32"	2"
	Milímetros	14,28mm	15,87mm	17,46mm	17,78mm	19,05mm	20,63mm	22,22mm	23,81mm	25,40mm	26,98mm	28,57mm	31,75mm	34,92mm	38,10mm	41,27mm	44,45mm	46,83mm	50,80mm

PEÇA	DESCRIÇÃO	MARCA	VEÍCULO		ANOS	SOMENTE PARA
C-1478	REPARO DO CILINDRO DE RODA 50,80mm	MERCEDES BENZ - CAMINHÕES	L-1519	->	1973/1990	
C-1478	REPARO DO CILINDRO DE RODA 50,80mm	MERCEDES BENZ - CAMINHÕES	L-2013	->	1973/1976	
C-1479	REPARO DE VEDAÇÃO DA PINÇA 48,00mm	FORD	BELINA	<-	1969/1977	
C-1479	REPARO DE VEDAÇÃO DA PINÇA 48,00mm	FORD	BELINA II	<-	1978/1989	SIST. BENDIX COIFA C/ ENCAIXE EXTERNO
C-1479	REPARO DE VEDAÇÃO DA PINÇA 48,00mm	FORD	CORCEL	<-	1968/1977	
C-1479	REPARO DE VEDAÇÃO DA PINÇA 48,00mm	FORD	CORCEL II	<-	1978/1986	SIST. BENDIX COIFA C/ ENCAIXE EXTERNO
C-1479	REPARO DE VEDAÇÃO DA PINÇA 48,00mm	FORD	DEL REY	<-	1981/1989	SIST. BENDIX COIFA C/ ENCAIXE EXTERNO
C-1479	REPARO DE VEDAÇÃO DA PINÇA 48,00mm	FORD	PAMPA	<-	1982/1983	SIST. BENDIX COIFA C/ ENCAIXE EXTERNO
C-1480	REPARO DE VEDAÇÃO DA PINÇA 54,00mm	GM - CHEVROLET	CARAVAN	<-	1975/1992	SIST. VARGA
C-1480	REPARO DE VEDAÇÃO DA PINÇA 54,00mm	GM - CHEVROLET	OPALA	<-	1971/1992	SIST. VARGA
C-1480	REPARO DE VEDAÇÃO DA PINÇA 54,00mm	PUMA	GTB	<-	1974/1980	SIST. VARGA
C-1481	REPARO DO CILINDRO DE RODA 19,05mm	FORD	BELINA II	->	1978/1991	SIST. VARGA
C-1481	REPARO DO CILINDRO DE RODA 19,05mm	FORD	CORCEL II	->	1978/1986	SIST. VARGA
C-1481	REPARO DO CILINDRO DE RODA 19,05mm	FORD	DEL REY	->	1981/1991	SIST. VARGA
C-1481	REPARO DO CILINDRO DE RODA 19,05mm	FORD	ESCORT	->	1993/1996	SIST. VARGA
C-1481	REPARO DO CILINDRO DE RODA 19,05mm	FORD	FIESTA	->	1996/2002	MOTOR 1.4/1.6
C-1481	REPARO DO CILINDRO DE RODA 19,05mm	FORD	FIESTA STREET HATCH	->	2002/2007	MOTOR 1.6
C-1481	REPARO DO CILINDRO DE RODA 19,05mm	FORD	FIESTA STREET SEDAN	->	2002/2004	
C-1481	REPARO DO CILINDRO DE RODA 19,05mm	FORD	FOCUS	->	2004/2009	MOTOR 1.6 8V
C-1481	REPARO DO CILINDRO DE RODA 19,05mm	FORD	KA	->	2001/...	MOTOR 1.6
C-1481	REPARO DO CILINDRO DE RODA 19,05mm	FORD	PAMPA	->	1982/1997	C/ TRAÇÃO 4X2
C-1481	REPARO DO CILINDRO DE RODA 19,05mm	FORD	VERONA	->	1994/1996	SIST. VARGA
C-1481	REPARO DO CILINDRO DE RODA 19,05mm	GM - CHEVROLET	CARAVAN	->	1975/1980	
C-1481	REPARO DO CILINDRO DE RODA 19,05mm	GM - CHEVROLET	CHEVETTE	->	1978/1986	SIST. VARGA
C-1481	REPARO DO CILINDRO DE RODA 19,05mm	GM - CHEVROLET	CHEVY	->	1983/1986	SIST. VARGA
C-1481	REPARO DO CILINDRO DE RODA 19,05mm	GM - CHEVROLET	MARAJÓ	->	1981/1986	SIST. VARGA
C-1481	REPARO DO CILINDRO DE RODA 19,05mm	GM - CHEVROLET	OPALA	->	1971/1980	SIST. VARGA
C-1481	REPARO DO CILINDRO DE RODA 19,05mm	HONDA	CIVIC	->	2001/2006	
C-1481	REPARO DO CILINDRO DE RODA 19,05mm	HYUNDAI	ACCENT	->	1995/2002	
C-1481	REPARO DO CILINDRO DE RODA 19,05mm	HYUNDAI	COUPE	->	1997/1981	
C-1481	REPARO DO CILINDRO DE RODA 19,05mm	HYUNDAI	ELANTRA	->	1992/2004	
C-1481	REPARO DO CILINDRO DE RODA 19,05mm	HYUNDAI	H-100	->	1995/1999	
C-1481	REPARO DO CILINDRO DE RODA 19,05mm	HYUNDAI	MATRIX	->	2002/2004	
C-1481	REPARO DO CILINDRO DE RODA 19,05mm	HYUNDAI	PORTER	->	2000/2003	
C-1481	REPARO DO CILINDRO DE RODA 19,05mm	HYUNDAI	SONATA	->	1994/2005	
C-1481	REPARO DO CILINDRO DE RODA 19,05mm	HYUNDAI	TERRACAN	->	2003/2006	
C-1481	REPARO DO CILINDRO DE RODA 19,05mm	KIA	SOUL	->	2009/...	
C-1481	REPARO DO CILINDRO DE RODA 19,05mm	PUMA	GTB	->	1974/1980	
C-1481	REPARO DO CILINDRO DE RODA 19,05mm	VOLKSWAGEN	LOGUS	->	1993/1996	SIST. VARGA
C-1481	REPARO DO CILINDRO DE RODA 19,05mm	VOLKSWAGEN	POINTER	->	1994/1996	SIST. VARGA
C-1485	REPARO DO CILINDRO DE RODA 41,27mm	CHRYSLER - CAMINHÕES	D-700	->	1974/1981	P/ CILINDRO BENDIX
C-1485	REPARO DO CILINDRO DE RODA 41,27mm	FIAT - CAMINHÕES	120	<-	1979/1985	
C-1485	REPARO DO CILINDRO DE RODA 41,27mm	FIAT - CAMINHÕES	120	->	1979/1985	
C-1485	REPARO DO CILINDRO DE RODA 41,27mm	FORD - CAMINHÕES	F-600	->	1956/1980	
C-1485	REPARO DO CILINDRO DE RODA 41,27mm	FORD - CAMINHÕES	F-7000	->	1972/1980	
C-1485	REPARO DO CILINDRO DE RODA 41,27mm	FORD - CAMINHÕES	F-11000	->	1980/1992	
C-1485	REPARO DO CILINDRO DE RODA 41,27mm	GM - CAMINHÕES	C-60	->	1964/1971	TERCEIRO EIXO
C-1485	REPARO DO CILINDRO DE RODA 41,27mm	GM - CAMINHÕES	C-60	->	1972/1979	
C-1485	REPARO DO CILINDRO DE RODA 41,27mm	GM - CAMINHÕES	D-60 (11000/12000)	->	1964/1971	TERCEIRO EIXO
C-1485	REPARO DO CILINDRO DE RODA 41,27mm	GM - CAMINHÕES	D-60 (11000/12000)	->	1972/1979	
C-1485	REPARO DO CILINDRO DE RODA 41,27mm	VOLKSWAGEN - CAMINHÕES	E-11	->	1981/1983	P/ CILINDRO BENDIX
C-1486	REPARO DO CILINDRO DE RODA 25,40mm	TOYOTA	BANDEIRANTE	<-	1966/1979	
C-1486	REPARO DO CILINDRO DE RODA 25,40mm	TOYOTA	BANDEIRANTE	->	1966/1979	
C-1487	REPARO DO CILINDRO DE RODA 41,27mm	CHRYSLER - CAMINHÕES	D-700	->	1970/1981	P/ CILINDRO VARGA
C-1487	REPARO DO CILINDRO DE RODA 41,27mm	GM - CAMINHÕES	C-60	->	1964/1971	P/ CILINDRO VARGA TERCEIRO EIXO
C-1487	REPARO DO CILINDRO DE RODA 41,27mm	GM - CAMINHÕES	C-60	->	1972/1979	P/ CILINDRO VARGA
C-1487	REPARO DO CILINDRO DE RODA 41,27mm	GM - CAMINHÕES	D-60 (11000/12000)	->	1964/1971	P/ CILINDRO VARGA TERCEIRO EIXO
C-1487	REPARO DO CILINDRO DE RODA 41,27mm	GM - CAMINHÕES	D-60 (11000/12000)	->	1972/1979	P/ CILINDRO VARGA
C-1487	REPARO DO CILINDRO DE RODA 41,27mm	VOLKSWAGEN - CAMINHÕES	E-11	->	1981/1983	P/ CILINDRO VARGA
C-1488	REPARO DO CILINDRO DE RODA 22,22mm	MERCEDES BENZ - CAMINHÕES	L/LO-608 D/E	<-	1972/1986	
C-1488	REPARO DO CILINDRO DE RODA 22,22mm	MERCEDES BENZ - CAMINHÕES	L/LO-608 D/E	->	1972/1986	
C-1489	REPARO DO CILINDRO DE RODA 15,87mm	FORD	BELINA II	->	1984/1987	C/ TRAÇÃO 4X4

Tabela de Conversão	Polegadas	9/16"	5/8"	11/16"	7/10"	3/4"	13/16"	7/8"	15/16"	1"	1 1/16"	1 1/8"	1 1/4"	1 3/8"	1 1/2"	1 5/8"	1 3/4"	1 27/32"	2"
	Milímetros		14,28mm	15,87mm	17,46mm	17,78mm	19,05mm	20,63mm	22,22mm	23,81mm	25,40mm	26,98mm	28,57mm	31,75mm	34,92mm	38,10mm	41,27mm	44,45mm	46,83mm

PEÇA	DESCRIÇÃO	MARCA	VEÍCULO		ANOS	SOMENTE PARA
C-1489	REPARO DO CILINDRO DE RODA 15,87mm	FORD	CORCEL	->	1968/1977	
C-1490	REPARO DE VEDAÇÃO DA PINÇA 48,00mm	GM - CHEVROLET	CHEVETTE	<-	1973/1994	
C-1490	REPARO DE VEDAÇÃO DA PINÇA 48,00mm	GM - CHEVROLET	CHEVY	<-	1983/1995	
C-1490	REPARO DE VEDAÇÃO DA PINÇA 48,00mm	GM - CHEVROLET	MARAJÓ	<-	1981/1989	
C-1492	REPARO DO CILINDRO DE RODA 19,05mm	GM - CHEVROLET	CHEVETTE	->	1973/1986	SIST. BOSCH
C-1492	REPARO DO CILINDRO DE RODA 19,05mm	GM - CHEVROLET	CHEVY	->	1983/1986	SIST. BOSCH
C-1492	REPARO DO CILINDRO DE RODA 19,05mm	GM - CHEVROLET	MARAJÓ	->	1981/1986	SIST. BOSCH
C-1493	REPARO DE VEDAÇÃO DA PINÇA 44,00mm	GURGEL	BR-800/SUPERMINI	<-	1989/1993	
C-1493	REPARO DE VEDAÇÃO DA PINÇA 44,00mm	VOLKSWAGEN	GOL (G1)	<-	1980/1996	MOTOR 1.0/1.3/1.6
C-1493	REPARO DE VEDAÇÃO DA PINÇA 44,00mm	VOLKSWAGEN	GOL (G2)	<-	1995/1995	SIST. ATE C/MOTOR 1.0/1.6 S/ABS
C-1493	REPARO DE VEDAÇÃO DA PINÇA 44,00mm	VOLKSWAGEN	PARATI (G1)	<-	1983/1996	MOTOR 1.5/1.6
C-1493	REPARO DE VEDAÇÃO DA PINÇA 44,00mm	VOLKSWAGEN	PASSAT	<-	1973/1989	MOTOR 1.5/1.6
C-1493	REPARO DE VEDAÇÃO DA PINÇA 44,00mm	VOLKSWAGEN	SAVEIRO (G1)	<-	1982/1997	MOTOR 1.6
C-1493	REPARO DE VEDAÇÃO DA PINÇA 44,00mm	VOLKSWAGEN	VOYAGE (G1)	<-	1982/1996	MOTOR 1.5/1.6
C-1494	REPARO DO CILINDRO DE RODA 14,28mm	FORD	VERSAILLES	->	1991/1994	
C-1494	REPARO DO CILINDRO DE RODA 14,28mm	VOLKSWAGEN	GOL (G1)	->	1980/1996	
C-1494	REPARO DO CILINDRO DE RODA 14,28mm	VOLKSWAGEN	GOL (G2)	->	1995/2005	MOTOR 1.0/1.6/1.8 S/ABS
C-1494	REPARO DO CILINDRO DE RODA 14,28mm	VOLKSWAGEN	GOL (G3)	->	2000/2005	MOTOR 1.0/1.6/1.8 S/ABS
C-1494	REPARO DO CILINDRO DE RODA 14,28mm	VOLKSWAGEN	GOL (G4)	->	2006/...	
C-1494	REPARO DO CILINDRO DE RODA 14,28mm	VOLKSWAGEN	PASSAT	->	1973/1989	
C-1494	REPARO DO CILINDRO DE RODA 14,28mm	VOLKSWAGEN	SANTANA	->	1984/1994	
C-1494	REPARO DO CILINDRO DE RODA 14,28mm	VOLKSWAGEN	VOYAGE (G1)	->	1982/1996	
C-1495	REPARO DO CILINDRO DE RODA 23,81mm	GURGEL	G-15	->	1980/1981	
C-1495	REPARO DO CILINDRO DE RODA 23,81mm	VOLKSWAGEN	KOMBI	->	1976/1982	
C-1496	REPARO DO CILINDRO DE RODA 22,22mm	GURGEL	X-12/TOCANTINS	<-	1969/1980	
C-1496	REPARO DO CILINDRO DE RODA 22,22mm	GURGEL	X-12/TOCANTINS	->	1981/1993	
C-1496	REPARO DO CILINDRO DE RODA 22,22mm	GURGEL	XEF	->	1984/1986	
C-1496	REPARO DO CILINDRO DE RODA 22,22mm	PUMA	GT/GTE/GTS	<-	1968/1973	
C-1496	REPARO DO CILINDRO DE RODA 22,22mm	PUMA	GT/GTE/GTS	->	1977/1984	
C-1496	REPARO DO CILINDRO DE RODA 22,22mm	VOLKSWAGEN	BRASILIA	->	1973/1982	
C-1496	REPARO DO CILINDRO DE RODA 22,22mm	VOLKSWAGEN	FUSCA	<-	1957/1984	
C-1496	REPARO DO CILINDRO DE RODA 22,22mm	VOLKSWAGEN	KARMANN GHIA	<-	1957/1969	
C-1496	REPARO DO CILINDRO DE RODA 22,22mm	VOLKSWAGEN	KARMANN GHIA TC	->	1970/1976	
C-1496	REPARO DO CILINDRO DE RODA 22,22mm	VOLKSWAGEN	SEDAN 1600 4 PORTAS	->	1969/1971	
C-1496	REPARO DO CILINDRO DE RODA 22,22mm	VOLKSWAGEN	SP-1/SP-2	->	1972/1975	
C-1496	REPARO DO CILINDRO DE RODA 22,22mm	VOLKSWAGEN	TL	->	1969/1976	
C-1496	REPARO DO CILINDRO DE RODA 22,22mm	VOLKSWAGEN	VARIANT	->	1970/1977	
C-1496	REPARO DO CILINDRO DE RODA 22,22mm	VOLKSWAGEN	VARIANT II	->	1978/1980	
C-1498	REPARO DE VEDAÇÃO DA PINÇA 40,00mm	ALFA ROMEO	2300	->	1974/1986	
C-1498	REPARO DE VEDAÇÃO DA PINÇA 40,00mm	GURGEL	X-12/TOCANTINS	<-	1981/1993	
C-1498	REPARO DE VEDAÇÃO DA PINÇA 40,00mm	GURGEL	XEF	<-	1984/1986	
C-1498	REPARO DE VEDAÇÃO DA PINÇA 40,00mm	PUMA	GT/GTE/GTS	<-	1974/1984	
C-1498	REPARO DE VEDAÇÃO DA PINÇA 40,00mm	VOLKSWAGEN	BRASILIA	<-	1973/1982	
C-1498	REPARO DE VEDAÇÃO DA PINÇA 40,00mm	VOLKSWAGEN	FUSCA	<-	1970/1996	SIST. ATE
C-1498	REPARO DE VEDAÇÃO DA PINÇA 40,00mm	VOLKSWAGEN	KARMANN GHIA TC	<-	1970/1976	
C-1498	REPARO DE VEDAÇÃO DA PINÇA 40,00mm	VOLKSWAGEN	SEDAN 1600 4 PORTAS	<-	1969/1971	
C-1498	REPARO DE VEDAÇÃO DA PINÇA 40,00mm	VOLKSWAGEN	TL	<-	1969/1976	
C-1498	REPARO DE VEDAÇÃO DA PINÇA 40,00mm	VOLKSWAGEN	VARIANT	<-	1970/1977	
C-1499	REPARO DO CILINDRO DE RODA 17,46mm	GM - CHEVROLET	CHEVETTE	->	1977/1980	P/ CILINDRO BENDIX 11/16"
C-1500	REPARO DE VEDAÇÃO DA PINÇA 79,00mm	FORD	F-100	<-	1982/1987	(2 RODAS)
C-1500	REPARO DE VEDAÇÃO DA PINÇA 79,00mm	FORD	F-1000	<-	1979/1994	C/ TRACÇÃO 4X2 (2 RODAS)
C-1500	REPARO DE VEDAÇÃO DA PINÇA 79,00mm	FORD	F-2000	<-	1980/1987	(2 RODAS)
C-1500	REPARO DE VEDAÇÃO DA PINÇA 79,00mm	GM - CHEVROLET	A-10	<-	1985/1989	(2 RODAS)
C-1500	REPARO DE VEDAÇÃO DA PINÇA 79,00mm	GM - CHEVROLET	A-20	<-	1985/1992	(2 RODAS)
C-1500	REPARO DE VEDAÇÃO DA PINÇA 79,00mm	GM - CHEVROLET	BONANZA	<-	1990/1992	(2 RODAS)
C-1500	REPARO DE VEDAÇÃO DA PINÇA 79,00mm	GM - CHEVROLET	C-10/14/15/16	<-	1979/1989	(2 RODAS)
C-1500	REPARO DE VEDAÇÃO DA PINÇA 79,00mm	GM - CHEVROLET	C-20	<-	1985/1992	(2 RODAS)
C-1500	REPARO DE VEDAÇÃO DA PINÇA 79,00mm	GM - CHEVROLET	D-10	<-	1979/1984	(2 RODAS)
C-1500	REPARO DE VEDAÇÃO DA PINÇA 79,00mm	GM - CHEVROLET	D-20	<-	1985/1992	(2 RODAS)
C-1500	REPARO DE VEDAÇÃO DA PINÇA 79,00mm	GM - CHEVROLET	VERANEIO	<-	1979/1992	(2 RODAS)
C-1501	REPARO DE VEDAÇÃO DA PINÇA 57,00mm	ALFA ROMEO	2300	<-	1974/1986	
C-1501	REPARO DE VEDAÇÃO DA PINÇA 57,00mm	FORD	GALAXIE	<-	1969/1980	

Tabela de Conversão	Polegadas	9/16"	5/8"	11/16"	7/10"	3/4"	13/16"	7/8"	15/16"	1"	1 1/16"	1 1/8"	1 1/4"	1 3/8"	1 1/2"	1 5/8"	1 3/4"	1 27/32"	2"
	Milímetros	14,28mm	15,87mm	17,46mm	17,78mm	19,05mm	20,63mm	22,22mm	23,81mm	25,40mm	26,98mm	28,57mm	31,75mm	34,92mm	38,10mm	41,27mm	44,45mm	46,83mm	50,80mm

PEÇA	DESCRIÇÃO	MARCA	VEÍCULO		ANOS	SOMENTE PARA
C-1501	REPARO DE VEDAÇÃO DA PINÇA 57,00mm	FORD	MAVERICK	<-	1977/1979	
C-1501	REPARO DE VEDAÇÃO DA PINÇA 57,00mm	GM - CHEVROLET	CARAVAN	<-	1979/1991	SIST. ATE
C-1501	REPARO DE VEDAÇÃO DA PINÇA 57,00mm	GM - CHEVROLET	OPALA	<-	1979/1991	SIST. ATE
C-1501	REPARO DE VEDAÇÃO DA PINÇA 57,00mm	PUMA	GTB	<-	1979/1980	SIST. ATE
C-1503	REPARO DE VEDAÇÃO DA PINÇA 66,00mm	FORD	MAVERICK	<-	1973/1976	
C-1506	REPARO DE VEDAÇÃO DA PINÇA 44,00mm	VOLKSWAGEN	VARIANT II	<-	1978/1980	
C-1509	REPARO DO CILINDRO DE RODA 20,63mm	FORD	CORCEL II	->	1978/1979	P/ CILINDRO VARGA 13/16"
C-1509	REPARO DO CILINDRO DE RODA 20,63mm	HYUNDAI	EXCEL	->	1992/1995	
C-1509	REPARO DO CILINDRO DE RODA 20,63mm	TOYOTA	CORONA	->	1996/2000	
C-1510	REPARO DO CILINDRO DE RODA 20,63mm	FORD	BELINA II	->	1978/1981	P/ CILINDRO BENDIX 13/16"
C-1510	REPARO DO CILINDRO DE RODA 20,63mm	FORD	CORCEL II	->	1978/1981	P/ CILINDRO BENDIX 13/16"
C-1510	REPARO DO CILINDRO DE RODA 20,63mm	FORD	PAMPA	->	1983/1995	C/ TRAÇÃO 4X4
C-1515	REPARO DO CILINDRO DE RODA 17,46mm	GM - CHEVROLET	CHEVETTE	->	1978/1980	P/ CILINDRO VARGA 11/16"
C-1519	REPARO DO CILINDRO DE RODA 14,28mm	GM - CHEVROLET	CELTA	->	2003/...	
C-1519	REPARO DO CILINDRO DE RODA 14,28mm	GM - CHEVROLET	PRISMA	->	2007/2012	
C-1520	REPARO DO CILINDRO DE RODA 34,92mm	FIAT - CAMINHÕES	70/80	<-	1980/1985	
C-1520	REPARO DO CILINDRO DE RODA 34,92mm	FORD - CAMINHÕES	FB-4000	<-	1982/1985	
C-1521	REPARO DE VEDAÇÃO DA PINÇA 57,00mm	GM - CAMINHÕES	D-40	<-	1985/1997	
C-1521	REPARO DE VEDAÇÃO DA PINÇA 57,00mm	GMC	6-100	<-	1998/2002	
C-1521	REPARO DE VEDAÇÃO DA PINÇA 57,00mm	GMC	6-150	<-	1998/2002	
C-1522	REPARO DO CILINDRO DE RODA 23,81mm	MERCEDES BENZ - CAMINHÕES	L/LO-708 D/E	<-	1987/1988	
C-1522	REPARO DO CILINDRO DE RODA 23,81mm	MERCEDES BENZ - CAMINHÕES	L/LO-708 D/E	->	1987/1988	
C-1524	REPARO DO CILINDRO DE RODA 22,22mm	GM - CHEVROLET	CORSA PICK-UP	->	1995/2003	
C-1524	REPARO DO CILINDRO DE RODA 22,22mm	GM - CHEVROLET	IPANEMA	->	1990/1998	SIST. ATE
C-1524	REPARO DO CILINDRO DE RODA 22,22mm	GM - CHEVROLET	MONZA	->	1988/1996	SIST. ATE
C-1525	REPARO DE VEDAÇÃO DA PINÇA 54,00mm	GM - CHEVROLET	IPANEMA	<-	1990/1993	
C-1525	REPARO DE VEDAÇÃO DA PINÇA 54,00mm	GM - CHEVROLET	KADETT	<-	1989/1993	
C-1525	REPARO DE VEDAÇÃO DA PINÇA 54,00mm	GM - CHEVROLET	MONZA	<-	1988/1993	
C-1526	REPARO DE VEDAÇÃO DA PINÇA 60,00mm	MERCEDES BENZ - CAMINHÕES	L-709	<-	1989/1996	
C-1526	REPARO DE VEDAÇÃO DA PINÇA 60,00mm	MERCEDES BENZ - CAMINHÕES	L-710	<-	1996/2002	
C-1526	REPARO DE VEDAÇÃO DA PINÇA 60,00mm	MERCEDES BENZ - CAMINHÕES	LO-814	<-	1996/...	
C-1526	REPARO DE VEDAÇÃO DA PINÇA 60,00mm	MERCEDES BENZ - CAMINHÕES	L/LO-912	<-	1989/...	
C-1526	REPARO DE VEDAÇÃO DA PINÇA 60,00mm	MERCEDES BENZ - CAMINHÕES	L-914/914 E	<-	1996/...	
C-1526	REPARO DE VEDAÇÃO DA PINÇA 60,00mm	MERCEDES BENZ - CAMINHÕES	L-1114	<-	1996/...	
C-1527	REPARO DO CILINDRO DE RODA 20,63mm	GM - CHEVROLET	KADETT	->	1989/1998	SIST. ATE
C-1528	REPARO DE VEDAÇÃO DA PINÇA 76,00mm	AGRALE	1600 A/D RS/RD	<-	1990/1996	
C-1528	REPARO DE VEDAÇÃO DA PINÇA 76,00mm	AGRALE	1800 D RS/RD	<-	1990/1996	
C-1528	REPARO DE VEDAÇÃO DA PINÇA 76,00mm	AGRALE	VOLARE A5/V5	<-	2002/...	
C-1528	REPARO DE VEDAÇÃO DA PINÇA 76,00mm	AGRALE	VOLARE A6/V6	<-	1998/...	
C-1528	REPARO DE VEDAÇÃO DA PINÇA 76,00mm	FORD - CAMINHÕES	F-4000	<-	1985/1998	
C-1529	REPARO DO CILINDRO DE RODA 28,57mm	MERCEDES BENZ - CAMINHÕES	L-709	->	1989/1996	
C-1529	REPARO DO CILINDRO DE RODA 28,57mm	MERCEDES BENZ - CAMINHÕES	L-710	->	1996/2002	
C-1529	REPARO DO CILINDRO DE RODA 28,57mm	MERCEDES BENZ - CAMINHÕES	L/LO-912	->	1989/...	
C-1530	REPARO DE VEDAÇÃO DA PINÇA 54,00mm	CITROËN	BERLINGO	<-	2000/2002	FURGÃO
C-1530	REPARO DE VEDAÇÃO DA PINÇA 54,00mm	CITROËN	C3	<-	2003/2005	
C-1530	REPARO DE VEDAÇÃO DA PINÇA 54,00mm	CITROËN	XSARA	<-	1997/2000	1.8 16V
C-1530	REPARO DE VEDAÇÃO DA PINÇA 54,00mm	CITROËN	XSARA	<-	2001/2005	1.6 16V
C-1530	REPARO DE VEDAÇÃO DA PINÇA 54,00mm	CITROËN	XSARA BREAK	<-	1998/2000	1.8 16V
C-1530	REPARO DE VEDAÇÃO DA PINÇA 54,00mm	CITROËN	XSARA BREAK	<-	1999/2000	2.0 16V
C-1530	REPARO DE VEDAÇÃO DA PINÇA 54,00mm	CITROËN	XSARA BREAK	<-	2001/2005	1.6 16V
C-1530	REPARO DE VEDAÇÃO DA PINÇA 54,00mm	CITROËN	XSARA PICASSO	<-	2003/...	2.0 16V
C-1530	REPARO DE VEDAÇÃO DA PINÇA 54,00mm	CITROËN	XSARA PICASSO	<-	2006	1.6 16V
C-1530	REPARO DE VEDAÇÃO DA PINÇA 54,00mm	CITROËN	XSARA PICASSO	<-	2010/...	1.6 FLEX
C-1530	REPARO DE VEDAÇÃO DA PINÇA 54,00mm	PEUGEOT	206 SW	<-	2003/...	
C-1530	REPARO DE VEDAÇÃO DA PINÇA 54,00mm	PEUGEOT	306 BREAK	<-	1997/2002	1.8 16V
C-1530	REPARO DE VEDAÇÃO DA PINÇA 54,00mm	PEUGEOT	307	<-	2000/...	1.6 16V
C-1530	REPARO DE VEDAÇÃO DA PINÇA 54,00mm	PEUGEOT	PARTNER	<-	1997/2000	FURGÃO
C-1530	REPARO DE VEDAÇÃO DA PINÇA 54,00mm	PEUGEOT	PARTNER	<-	2001/2002	
C-1530	REPARO DE VEDAÇÃO DA PINÇA 54,00mm	PEUGEOT	PARTNER	<-	2001/2002	1.8 FURGÃO
C-1531	REPARO DO CILINDRO DE RODA 22,22mm	GM - CHEVROLET	ASTRA	->	2005/2011	
C-1531	REPARO DO CILINDRO DE RODA 22,22mm	GM - CHEVROLET	IPANEMA	->	1990/1998	SIST. BOSCH
C-1531	REPARO DO CILINDRO DE RODA 22,22mm	GM - CHEVROLET	MONTANA	->	2004/...	

Tabela de Conversão	Polegadas	9/16"	5/8"	11/16"	7/10"	3/4"	13/16"	7/8"	15/16"	1"	1 1/16"	1 1/8"	1 1/4"	1 3/8"	1 1/2"	1 5/8"	1 3/4"	1 27/32"	2"
	Milímetros		14,28mm	15,87mm	17,46mm	17,78mm	19,05mm	20,63mm	22,22mm	23,81mm	25,40mm	26,98mm	28,57mm	31,75mm	34,92mm	38,10mm	41,27mm	44,45mm	46,83mm



PEÇA	DESCRIÇÃO	MARCA	VEÍCULO		ANOS	SOMENTE PARA
C-1531	REPARO DO CILINDRO DE RODA 22,22mm	GM - CHEVROLET	MONZA	->	1988/1996	SIST. BOSCH
C-1531	REPARO DO CILINDRO DE RODA 22,22mm	GM - CHEVROLET	VECTRA	->	2006/2011	C/ VÁLVULA PROPORCIONADORA
C-1531	REPARO DO CILINDRO DE RODA 22,22mm	GM - CHEVROLET	ZAFIRA	->	2005/2012	
C-1532	REPARO DE VEDAÇÃO DA PINÇA 48,00mm	FIAT	DUNA	<-	1994/1996	SIST. VARGA
C-1532	REPARO DE VEDAÇÃO DA PINÇA 48,00mm	FIAT	ELBA	<-	1986/1996	SIST. VARGA
C-1532	REPARO DE VEDAÇÃO DA PINÇA 48,00mm	FIAT	FIORINO (mod. Uno)	<-	1988/1993	SIST. VARGA
C-1532	REPARO DE VEDAÇÃO DA PINÇA 48,00mm	FIAT	PRÊMIO	<-	1985/1996	SIST. VARGA
C-1532	REPARO DE VEDAÇÃO DA PINÇA 48,00mm	FIAT	UNO	<-	1984/1998	SIST. VARGA, BENDIX, WEBER E GIRLING
C-1532	REPARO DE VEDAÇÃO DA PINÇA 48,00mm	VOLKSWAGEN	GOLF	<-	1996/1998	MOD. GL SIST. GIRLING (fabr. México)
C-1534	REPARO DO CILINDRO DE RODA 20,63mm	FIAT	BRAVA	->	2000/2003	
C-1534	REPARO DO CILINDRO DE RODA 20,63mm	FIAT	DOBLÒ	->	2002/2012	EXCETO ADVENTURE
C-1534	REPARO DO CILINDRO DE RODA 20,63mm	FIAT	FIORINO (mod. Uno)	->	1994/...	
C-1534	REPARO DO CILINDRO DE RODA 20,63mm	FIAT	IDEA	->	2006/...	
C-1534	REPARO DO CILINDRO DE RODA 20,63mm	FIAT	MAREA	->	2000/2007	
C-1534	REPARO DO CILINDRO DE RODA 20,63mm	FIAT	MAREA WEEKEND	->	2000/2007	
C-1534	REPARO DO CILINDRO DE RODA 20,63mm	FIAT	PALIO WEEKEND	->	1997/2008	
C-1534	REPARO DO CILINDRO DE RODA 20,63mm	FIAT	PALIO WEEKEND	->	2009/...	SIST. BOSCH
C-1534	REPARO DO CILINDRO DE RODA 20,63mm	FIAT	STILO	->	2003/2011	
C-1534	REPARO DO CILINDRO DE RODA 20,63mm	FIAT	STRADA	->	1999/2012	
C-1534	REPARO DO CILINDRO DE RODA 20,63mm	FIAT	TEMPRA	->	1992/1999	
C-1534	REPARO DO CILINDRO DE RODA 20,63mm	FIAT	UNO TURBO	->	1994/1996	
C-1535	REPARO DE VEDAÇÃO DA PINÇA 43,00mm	GM - CHEVROLET	CARAVAN	->	1991/1992	
C-1535	REPARO DE VEDAÇÃO DA PINÇA 43,00mm	GM - CHEVROLET	OPALA	->	1991/1992	
C-1536	REPARO DO CILINDRO DE RODA 20,63mm	GM - CHEVROLET	KADETT	->	1989/1998	SIST. BOSCH
C-1537	REPARO DE VEDAÇÃO DA PINÇA 34,00mm	ALFA ROMEO	145	->	1996/1999	
C-1537	REPARO DE VEDAÇÃO DA PINÇA 34,00mm	ALFA ROMEO	155	->	1995/1998	
C-1537	REPARO DE VEDAÇÃO DA PINÇA 34,00mm	ALFA ROMEO	SPIDER	->	1996/1998	
C-1537	REPARO DE VEDAÇÃO DA PINÇA 34,00mm	FIAT	COUPÉ	->	1995/1997	
C-1537	REPARO DE VEDAÇÃO DA PINÇA 34,00mm	FIAT	MAREA	->	1999/2007	
C-1537	REPARO DE VEDAÇÃO DA PINÇA 34,00mm	FIAT	MAREA WEEKEND	->	1999/2007	
C-1537	REPARO DE VEDAÇÃO DA PINÇA 34,00mm	FIAT	TEMPRA SW	->	1994/1997	
C-1537	REPARO DE VEDAÇÃO DA PINÇA 34,00mm	FIAT	TIPO	->	1993/1995	
C-1537	REPARO DE VEDAÇÃO DA PINÇA 34,00mm	GM - CHEVROLET	IPANEMA	->	1992/1993	
C-1537	REPARO DE VEDAÇÃO DA PINÇA 34,00mm	GM - CHEVROLET	KADETT	->	1992/1993	
C-1537	REPARO DE VEDAÇÃO DA PINÇA 34,00mm	GM - CHEVROLET	MONZA	->	1992/1993	
C-1538	REPARO DE VEDAÇÃO DA PINÇA 57,00mm	GM - CHEVROLET	OMEGA	<-	1993/1998	MOTOR 6 CIL.
C-1538	REPARO DE VEDAÇÃO DA PINÇA 57,00mm	GM - CHEVROLET	SUPREMA	<-	1993/1997	MOTOR 6 CIL.
C-1539	REPARO DE VEDAÇÃO DA PINÇA 38,00mm	GM - CHEVROLET	OMEGA	->	1993/1998	MOTOR 6 CIL.
C-1540	REPARO DO CILINDRO DE RODA 22,00mm	FIAT	TIPO	->	1993/1997	
C-1541	REPARO DE VEDAÇÃO DA PINÇA 35,00mm	GM - CHEVROLET	ASTRA	->	1999/2011	
C-1541	REPARO DE VEDAÇÃO DA PINÇA 35,00mm	GM - CHEVROLET	CALIBRA	->	1993/1995	
C-1541	REPARO DE VEDAÇÃO DA PINÇA 35,00mm	GM - CHEVROLET	MERIVA	->	2003/2012	
C-1541	REPARO DE VEDAÇÃO DA PINÇA 35,00mm	GM - CHEVROLET	OMEGA	->	1993/1998	MOTOR 4 CIL.
C-1541	REPARO DE VEDAÇÃO DA PINÇA 35,00mm	GM - CHEVROLET	VECTRA	->	1994/2011	
C-1541	REPARO DE VEDAÇÃO DA PINÇA 35,00mm	GM - CHEVROLET	ZAFIRA	->	2002/2012	
C-1541	REPARO DE VEDAÇÃO DA PINÇA 35,00mm	MERCEDES BENZ	CLASSE E	->	1995/2002	MOD. 280/320/420
C-1541	REPARO DE VEDAÇÃO DA PINÇA 35,00mm	MERCEDES BENZ	CLK	->	1998/2002	MOD. 320
C-1542	REPARO DE VEDAÇÃO DA PINÇA 54,00mm	FORD	F-1000	<-	1993/1998	C/ TRACÇÃO 4X4
C-1542	REPARO DE VEDAÇÃO DA PINÇA 54,00mm	FORD	F-1000	<-	1995/1998	C/ TRACÇÃO 4X2
C-1542	REPARO DE VEDAÇÃO DA PINÇA 54,00mm	GM - CHEVROLET	A-20	<-	1993/1996	
C-1542	REPARO DE VEDAÇÃO DA PINÇA 54,00mm	GM - CHEVROLET	BONANZA	<-	1993/1996	
C-1542	REPARO DE VEDAÇÃO DA PINÇA 54,00mm	GM - CHEVROLET	C-20	<-	1993/1996	
C-1542	REPARO DE VEDAÇÃO DA PINÇA 54,00mm	GM - CHEVROLET	D-20	<-	1993/1996	
C-1542	REPARO DE VEDAÇÃO DA PINÇA 54,00mm	GM - CHEVROLET	GRAND BLAZER	<-	1998/2000	
C-1542	REPARO DE VEDAÇÃO DA PINÇA 54,00mm	GM - CHEVROLET	SILVERADO	<-	1997/2001	
C-1542	REPARO DE VEDAÇÃO DA PINÇA 54,00mm	GM - CHEVROLET	VERANEIO	<-	1993/1996	
C-1542	REPARO DE VEDAÇÃO DA PINÇA 54,00mm	GMC	3500 HD	<-	1997/2002	
C-1543	REPARO DO CILINDRO DE RODA 19,05mm	DAEWOO	ESPERO	->	1993/1998	
C-1543	REPARO DO CILINDRO DE RODA 19,05mm	DAEWOO	LANOS	->	1997/2000	
C-1543	REPARO DO CILINDRO DE RODA 19,05mm	GM - CHEVROLET	AGILE	->	2010/...	
C-1543	REPARO DO CILINDRO DE RODA 19,05mm	GM - CHEVROLET	ASTRA	->	1995/2005	
C-1543	REPARO DO CILINDRO DE RODA 19,05mm	GM - CHEVROLET	COBALT	->	2012/...	

Tabela de Conversão	Polegadas	9/16"	5/8"	11/16"	7/10"	3/4"	13/16"	7/8"	15/16"	1"	1 1/16"	1 1/8"	1 1/4"	1 3/8"	1 1/2"	1 5/8"	1 3/4"	1 27/32"	2"
	Milímetros	14,28mm	15,87mm	17,46mm	17,78mm	19,05mm	20,63mm	22,22mm	23,81mm	25,40mm	26,98mm	28,57mm	31,75mm	34,92mm	38,10mm	41,27mm	44,45mm	46,83mm	50,80mm

PEÇA	DESCRIÇÃO	MARCA	VEÍCULO		ANOS	SOMENTE PARA
C-1543	REPARO DO CILINDRO DE RODA 19,05mm	GM - CHEVROLET	CORSA	->	1994/2012	
C-1543	REPARO DO CILINDRO DE RODA 19,05mm	GM - CHEVROLET	CORSA CLASSIC	->	2003/...	
C-1543	REPARO DO CILINDRO DE RODA 19,05mm	GM - CHEVROLET	MERIVA	->	2003/2012	
C-1543	REPARO DO CILINDRO DE RODA 19,05mm	GM - CHEVROLET	TIGRA	->	1998/1999	
C-1543	REPARO DO CILINDRO DE RODA 19,05mm	GM - CHEVROLET	VECTRA	->	1997/2005	
C-1543	REPARO DO CILINDRO DE RODA 19,05mm	GM - CHEVROLET	VECTRA	->	2006/2011	S/ VÁLVULA PROPORCIONADORA
C-1543	REPARO DO CILINDRO DE RODA 19,05mm	GM - CHEVROLET	ZAFIRA	->	2002/2005	
C-1544	REPARO DO CILINDRO DE RODA 22,22mm	MITSUBISHI	L200	->	1992/2006	L/GL/GLS 4X4
C-1544	REPARO DO CILINDRO DE RODA 22,22mm	MITSUBISHI	PAJERO	->	1994/1997	MOTOR 2.8 DIESEL 4X4
C-1545	REPARO DE VEDAÇÃO DA PINÇA 60,00mm	BMW	SÉRIE 3	<-	1992/1999	MOD. M3
C-1545	REPARO DE VEDAÇÃO DA PINÇA 60,00mm	BMW	SÉRIE 5	<-	1991/1995	
C-1545	REPARO DE VEDAÇÃO DA PINÇA 60,00mm	BMW	SÉRIE 5	<-	1996/2003	MOD. 530/535/540/M5
C-1545	REPARO DE VEDAÇÃO DA PINÇA 60,00mm	BMW	SÉRIE 5 TOURING	<-	1991/1997	
C-1545	REPARO DE VEDAÇÃO DA PINÇA 60,00mm	BMW	SÉRIE 5 TOURING	<-	1997/2004	MOD. 530/540
C-1545	REPARO DE VEDAÇÃO DA PINÇA 60,00mm	BMW	SÉRIE 7	<-	1991/1994	
C-1545	REPARO DE VEDAÇÃO DA PINÇA 60,00mm	BMW	SÉRIE 7	<-	1994/2001	MOD. 740
C-1545	REPARO DE VEDAÇÃO DA PINÇA 60,00mm	BMW	SÉRIE 8	<-	1990/1999	
C-1545	REPARO DE VEDAÇÃO DA PINÇA 60,00mm	BMW	X5	<-	2000/...	E353
C-1545	REPARO DE VEDAÇÃO DA PINÇA 60,00mm	BMW	Z3	<-	1997/2003	MOD. M 3.2
C-1545	REPARO DE VEDAÇÃO DA PINÇA 60,00mm	FORD	ESCORT	<-	1993/1996	MOD. XR3
C-1545	REPARO DE VEDAÇÃO DA PINÇA 60,00mm	FORD	MONDEO	<-	1994/2001	
C-1545	REPARO DE VEDAÇÃO DA PINÇA 60,00mm	FORD	MONDEO SW	<-	1994/2001	
C-1545	REPARO DE VEDAÇÃO DA PINÇA 60,00mm	JAGUAR	XJ-6	<-	1994/1997	
C-1545	REPARO DE VEDAÇÃO DA PINÇA 60,00mm	JAGUAR	XJ-12	<-	1993/1997	
C-1545	REPARO DE VEDAÇÃO DA PINÇA 60,00mm	VOLKSWAGEN	POINTER	<-	1994/1996	MOD. GTi
C-1546	REPARO DE VEDAÇÃO DA PINÇA 33,00mm	FORD	ESCORT	->	1993/1996	
C-1546	REPARO DE VEDAÇÃO DA PINÇA 33,00mm	KIA	SEPHIA	->	1993/2001	
C-1546	REPARO DE VEDAÇÃO DA PINÇA 33,00mm	VOLKSWAGEN	GOL (G2)	->	1995/2000	
C-1546	REPARO DE VEDAÇÃO DA PINÇA 33,00mm	VOLKSWAGEN	GOL (G3)	->	2000/2000	
C-1546	REPARO DE VEDAÇÃO DA PINÇA 33,00mm	VOLKSWAGEN	PARATI (G2, G3 e G4)	->	1996/2000	
C-1546	REPARO DE VEDAÇÃO DA PINÇA 33,00mm	VOLKSWAGEN	POINTER	->	1994/1996	
C-1547	REPARO DE VEDAÇÃO DA PINÇA 66,00mm	GM - CHEVROLET	BLAZER	<-	1996/2011	C/ TRACÇÃO 4X2
C-1547	REPARO DE VEDAÇÃO DA PINÇA 66,00mm	GM - CHEVROLET	S-10	<-	1995/2012	C/ TRACÇÃO 4X2
C-1547	REPARO DE VEDAÇÃO DA PINÇA 66,00mm	TOYOTA	BANDEIRANTE	<-	1995/2001	
C-1549	REPARO DE VEDAÇÃO DA PINÇA 38,00mm	ALFA ROMEO	164	->	1991/1997	
C-1549	REPARO DE VEDAÇÃO DA PINÇA 38,00mm	AUDI	80	->	1993/1995	
C-1549	REPARO DE VEDAÇÃO DA PINÇA 38,00mm	AUDI	80 AVANT	->	1993/1996	
C-1549	REPARO DE VEDAÇÃO DA PINÇA 38,00mm	AUDI	100	->	1993/1995	
C-1549	REPARO DE VEDAÇÃO DA PINÇA 38,00mm	AUDI	100 AVANT	->	1994/1995	
C-1549	REPARO DE VEDAÇÃO DA PINÇA 38,00mm	AUDI	A6	->	1994/1997	
C-1549	REPARO DE VEDAÇÃO DA PINÇA 38,00mm	AUDI	A6 AVANT	->	1994/1997	
C-1549	REPARO DE VEDAÇÃO DA PINÇA 38,00mm	FIAT	TEMPRA	->	1993/1999	
C-1549	REPARO DE VEDAÇÃO DA PINÇA 38,00mm	PEUGEOT	405	->	1992/1995	
C-1549	REPARO DE VEDAÇÃO DA PINÇA 38,00mm	VOLKSWAGEN	GOLF	->	1994/1998	
C-1549	REPARO DE VEDAÇÃO DA PINÇA 38,00mm	VOLKSWAGEN	PASSAT	->	1991/1997	
C-1549	REPARO DE VEDAÇÃO DA PINÇA 38,00mm	VOLKSWAGEN	PASSAT VARIANT	->	1991/1997	
C-1549	REPARO DE VEDAÇÃO DA PINÇA 38,00mm	VOLVO	S40	->	1996/2003	SIST. GIRLING
C-1549	REPARO DE VEDAÇÃO DA PINÇA 38,00mm	VOLVO	V40	->	1997/2004	SIST. GIRLING
C-1550	REPARO DE VEDAÇÃO DA PINÇA 48,00mm	GM - CHEVROLET	CELTA	<-	2001/...	
C-1550	REPARO DE VEDAÇÃO DA PINÇA 48,00mm	GM - CHEVROLET	CORSA	<-	1994/2002	SIST. ATE
C-1550	REPARO DE VEDAÇÃO DA PINÇA 48,00mm	GM - CHEVROLET	CORSA CLASSIC	<-	2003/...	SIST. ATE
C-1550	REPARO DE VEDAÇÃO DA PINÇA 48,00mm	GM - CHEVROLET	CORSA PICK-UP	<-	1995/2003	SIST. ATE
C-1550	REPARO DE VEDAÇÃO DA PINÇA 48,00mm	GM - CHEVROLET	PRISMA	<-	2007/2012	
C-1550	REPARO DE VEDAÇÃO DA PINÇA 48,00mm	GM - CHEVROLET	TIGRA	<-	1998/1999	SIST. ATE
C-1551	REPARO DE VEDAÇÃO DA PINÇA 38,00mm	ALFA ROMEO	147	->	2003/2006	
C-1551	REPARO DE VEDAÇÃO DA PINÇA 38,00mm	ALFA ROMEO	156	->	1999/2003	
C-1551	REPARO DE VEDAÇÃO DA PINÇA 38,00mm	ALFA ROMEO	156 SPORTWAGON	->	2001/2004	
C-1551	REPARO DE VEDAÇÃO DA PINÇA 38,00mm	ALFA ROMEO	159	->	2007/2009	
C-1551	REPARO DE VEDAÇÃO DA PINÇA 38,00mm	ALFA ROMEO	166	->	1999/2003	
C-1551	REPARO DE VEDAÇÃO DA PINÇA 38,00mm	AUDI	A3	->	1997/...	
C-1551	REPARO DE VEDAÇÃO DA PINÇA 38,00mm	AUDI	A3 SPORTBACK	->	2007/...	
C-1551	REPARO DE VEDAÇÃO DA PINÇA 38,00mm	AUDI	A4	->	1995/2008	

Tabela de Conversão	Polegadas	9/16"	5/8"	11/16"	7/10"	3/4"	13/16"	7/8"	15/16"	1"	1 1/16"	1 1/8"	1 1/4"	1 3/8"	1 1/2"	1 5/8"	1 3/4"	1 27/32"	2"
	Milímetros		14,28mm	15,87mm	17,46mm	17,78mm	19,05mm	20,63mm	22,22mm	23,81mm	25,40mm	26,98mm	28,57mm	31,75mm	34,92mm	38,10mm	41,27mm	44,45mm	46,83mm

PEÇA	DESCRIÇÃO	MARCA	VEÍCULO		ANOS	SOMENTE PARA
C-1551	REPARO DE VEDAÇÃO DA PINÇA 38,00mm	AUDI	A4 AVANT	->	1995/2008	
C-1551	REPARO DE VEDAÇÃO DA PINÇA 38,00mm	AUDI	A6	->	1998/2004	
C-1551	REPARO DE VEDAÇÃO DA PINÇA 38,00mm	AUDI	A6 AVANT	->	1998/2004	
C-1551	REPARO DE VEDAÇÃO DA PINÇA 38,00mm	AUDI	TT	->	1999/...	
C-1551	REPARO DE VEDAÇÃO DA PINÇA 38,00mm	CITROËN	C3	->	2002/2012	
C-1551	REPARO DE VEDAÇÃO DA PINÇA 38,00mm	CITROËN	C4	->	2004/...	SIST. TRW
C-1551	REPARO DE VEDAÇÃO DA PINÇA 38,00mm	CITROËN	C5	->	2008/...	SIST. TRW
C-1551	REPARO DE VEDAÇÃO DA PINÇA 38,00mm	CITROËN	C6	->	2006/2008	
C-1551	REPARO DE VEDAÇÃO DA PINÇA 38,00mm	CITROËN	C8	->	2003/2005	
C-1551	REPARO DE VEDAÇÃO DA PINÇA 38,00mm	PEUGEOT	307	->	2001/2012	SIST. TRW
C-1551	REPARO DE VEDAÇÃO DA PINÇA 38,00mm	PEUGEOT	407	->	2004/2009	
C-1551	REPARO DE VEDAÇÃO DA PINÇA 38,00mm	PEUGEOT	607	->	2000/2005	
C-1551	REPARO DE VEDAÇÃO DA PINÇA 38,00mm	PEUGEOT	807	->	2004/2005	
C-1551	REPARO DE VEDAÇÃO DA PINÇA 38,00mm	PEUGEOT	3008	->	2011/...	
C-1551	REPARO DE VEDAÇÃO DA PINÇA 38,00mm	RENAULT	GRAND SCENIC	->	2008/2009	
C-1551	REPARO DE VEDAÇÃO DA PINÇA 38,00mm	VOLKSWAGEN	CARAVELLE	->	1998/1999	
C-1551	REPARO DE VEDAÇÃO DA PINÇA 38,00mm	VOLKSWAGEN	EOS	->	2008/2012	
C-1551	REPARO DE VEDAÇÃO DA PINÇA 38,00mm	VOLKSWAGEN	EUROVAN	->	1998/1999	
C-1551	REPARO DE VEDAÇÃO DA PINÇA 38,00mm	VOLKSWAGEN	GOLF	->	1999/...	
C-1551	REPARO DE VEDAÇÃO DA PINÇA 38,00mm	VOLKSWAGEN	NEW BEETLE	->	2000/2010	
C-1551	REPARO DE VEDAÇÃO DA PINÇA 38,00mm	VOLKSWAGEN	PASSAT	->	1998/2005	
C-1551	REPARO DE VEDAÇÃO DA PINÇA 38,00mm	VOLKSWAGEN	PASSAT VARIANT	->	1998/2005	
C-1551	REPARO DE VEDAÇÃO DA PINÇA 38,00mm	VOLKSWAGEN	POLO	->	2002/...	
C-1551	REPARO DE VEDAÇÃO DA PINÇA 38,00mm	VOLVO	S40	->	1996/2003	SIST. LUCAS
C-1551	REPARO DE VEDAÇÃO DA PINÇA 38,00mm	VOLVO	V40	->	1997/2004	SIST. LUCAS
C-1552	REPARO DE VEDAÇÃO DA PINÇA 54,00mm	GM - CHEVROLET	IPANEMA	<-	1994/1997	
C-1552	REPARO DE VEDAÇÃO DA PINÇA 54,00mm	GM - CHEVROLET	KADETT	<-	1994/1997	
C-1552	REPARO DE VEDAÇÃO DA PINÇA 54,00mm	GM - CHEVROLET	MONZA	<-	1994/1996	
C-1553	REPARO DE VEDAÇÃO DA PINÇA 34,00mm	GM - CHEVROLET	IPANEMA	->	1994/1998	
C-1553	REPARO DE VEDAÇÃO DA PINÇA 34,00mm	GM - CHEVROLET	KADETT	->	1994/1998	
C-1553	REPARO DE VEDAÇÃO DA PINÇA 34,00mm	GM - CHEVROLET	MONZA	->	1994/1996	
C-1554	REPARO DO CILINDRO DE RODA 19,05mm	FORD	ESCORT	->	1993/1996	SIST. BOSCH
C-1554	REPARO DO CILINDRO DE RODA 19,05mm	FORD	VERONA	->	1994/1996	SIST. BOSCH
C-1554	REPARO DO CILINDRO DE RODA 19,05mm	VOLKSWAGEN	LOGUS	->	1993/1996	SIST. BOSCH
C-1554	REPARO DO CILINDRO DE RODA 19,05mm	VOLKSWAGEN	POINTER	->	1994/1996	SIST. BOSCH
C-1555	REPARO DO CILINDRO DE RODA 20,63mm	FIAT	PALIO	->	1999/2011	C/ABS
C-1555	REPARO DO CILINDRO DE RODA 20,63mm	FIAT	PALIO	->	2012/...	MOD. FIRE C/ABS
C-1555	REPARO DO CILINDRO DE RODA 20,63mm	FIAT	SIENA	->	1999/2000	C/ABS
C-1555	REPARO DO CILINDRO DE RODA 20,63mm	FIAT	SIENA	->	2001/...	MOTOR 1.6/1.8
C-1555	REPARO DO CILINDRO DE RODA 20,63mm	FIAT	SIENA	->	2001/...	MOTOR 1.0/1.3 C/ABS
C-1555	REPARO DO CILINDRO DE RODA 20,63mm	FIAT	UNO	->	2011/...	S/ABS
C-1555	REPARO DO CILINDRO DE RODA 20,63mm	FORD	ECOSPORT	->	2003/2012	4X2 S/ABS
C-1555	REPARO DO CILINDRO DE RODA 20,63mm	FORD	FIESTA	->	2003/2006	MOTOR 1.6/1.0 SUPERCHARGER
C-1555	REPARO DO CILINDRO DE RODA 20,63mm	FORD	FIESTA SEDAN	->	2005/2006	
C-1556	REPARO DO CILINDRO DE RODA 19,05mm	FIAT	PALIO	->	1996/1998	
C-1556	REPARO DO CILINDRO DE RODA 19,05mm	FIAT	PALIO	->	1999/2011	S/ABS
C-1556	REPARO DO CILINDRO DE RODA 19,05mm	FIAT	PALIO	->	2012/...	MOD. FIRE S/ABS
C-1556	REPARO DO CILINDRO DE RODA 19,05mm	FIAT	SIENA	->	1998/1998	
C-1556	REPARO DO CILINDRO DE RODA 19,05mm	FIAT	SIENA	->	1999/2000	S/ABS
C-1556	REPARO DO CILINDRO DE RODA 19,05mm	FIAT	SIENA	->	2001/...	MOTOR 1.0/1.3 S/ABS
C-1556	REPARO DO CILINDRO DE RODA 19,05mm	FIAT	UNO	->	2008/2010	
C-1556	REPARO DO CILINDRO DE RODA 19,05mm	FIAT	UNO	->	2011/...	MILLE/FURGÃO
C-1556	REPARO DO CILINDRO DE RODA 19,05mm	FORD	ECOSPORT	->	2006/2012	4X2 C/ABS
C-1556	REPARO DO CILINDRO DE RODA 19,05mm	FORD	FIESTA	->	2003/2006	MOTOR 1.0
C-1556	REPARO DO CILINDRO DE RODA 19,05mm	FORD	FIESTA	->	2007/...	
C-1556	REPARO DO CILINDRO DE RODA 19,05mm	FORD	FIESTA SEDAN	->	2007/...	
C-1557	REPARO DO CILINDRO DE RODA 19,00mm	FORD	FIESTA	->	1995/1995	
C-1558	REPARO DE VEDAÇÃO DA PINÇA 54,00mm	ALFA ROMEO	145	<-	1996/1999	SIST. GIRLING
C-1558	REPARO DE VEDAÇÃO DA PINÇA 54,00mm	ALFA ROMEO	155	<-	1995/1998	
C-1558	REPARO DE VEDAÇÃO DA PINÇA 54,00mm	ALFA ROMEO	164	<-	1991/1997	
C-1558	REPARO DE VEDAÇÃO DA PINÇA 54,00mm	AUDI	80	<-	1993/1995	MOTOR 2.0
C-1558	REPARO DE VEDAÇÃO DA PINÇA 54,00mm	AUDI	80 AVANT	<-	1993/1996	MOTOR 2.0

Tabela de Conversão	Polegadas	9/16"	5/8"	11/16"	7/10"	3/4"	13/16"	7/8"	15/16"	1"	1 1/16"	1 1/8"	1 1/4"	1 3/8"	1 1/2"	1 5/8"	1 3/4"	1 27/32"	2"
	Milímetros	14,28mm	15,87mm	17,46mm	17,78mm	19,05mm	20,63mm	22,22mm	23,81mm	25,40mm	26,98mm	28,57mm	31,75mm	34,92mm	38,10mm	41,27mm	44,45mm	46,83mm	50,80mm



PEÇA	DESCRIÇÃO	MARCA	VEÍCULO		ANOS	SOMENTE PARA
C-1558	REPARO DE VEDAÇÃO DA PINÇA 54,00mm	AUDI	A4	<-	1995/2000	SIST. GIRLING
C-1558	REPARO DE VEDAÇÃO DA PINÇA 54,00mm	AUDI	A4 AVANT	<-	1995/2001	SIST. GIRLING
C-1558	REPARO DE VEDAÇÃO DA PINÇA 54,00mm	CITROËN	ZX	<-	1992/1997	MOTOR 2,0 16V
C-1558	REPARO DE VEDAÇÃO DA PINÇA 54,00mm	FIAT	COUPÉ	<-	1995/1997	
C-1558	REPARO DE VEDAÇÃO DA PINÇA 54,00mm	FIAT	TEMPRA SW	<-	1994/1997	SIST. GIRLING/BENDIX
C-1558	REPARO DE VEDAÇÃO DA PINÇA 54,00mm	FIAT	TIPO	<-	1993/1995	MOTOR 1.6 ie
C-1558	REPARO DE VEDAÇÃO DA PINÇA 54,00mm	MERCEDES BENZ	CLASSE C	<-	1995/2000	MOD. 180/230
C-1558	REPARO DE VEDAÇÃO DA PINÇA 54,00mm	MERCEDES BENZ	CLASSE C TOURING	<-	1996/2001	MOD. 180/200/230
C-1558	REPARO DE VEDAÇÃO DA PINÇA 54,00mm	PEUGEOT	306	<-	1994/2002	SIST. LUCAS
C-1558	REPARO DE VEDAÇÃO DA PINÇA 54,00mm	PEUGEOT	405	<-	1992/1999	MOTOR 2.0 SIST. LUCAS
C-1558	REPARO DE VEDAÇÃO DA PINÇA 54,00mm	RENAULT	MEGANE	<-	1997/2005	
C-1558	REPARO DE VEDAÇÃO DA PINÇA 54,00mm	RENAULT	SCENIC	<-	1999/2011	
C-1558	REPARO DE VEDAÇÃO DA PINÇA 54,00mm	SEAT	CORDOBA	<-	2000/2002	
C-1558	REPARO DE VEDAÇÃO DA PINÇA 54,00mm	SEAT	CORDOBA VARIO	<-	2000/2002	
C-1558	REPARO DE VEDAÇÃO DA PINÇA 54,00mm	SEAT	IBIZA	<-	2000/2002	MOTOR 1.6
C-1558	REPARO DE VEDAÇÃO DA PINÇA 54,00mm	SEAT	INCA	<-	1999/2002	
C-1558	REPARO DE VEDAÇÃO DA PINÇA 54,00mm	VOLKSWAGEN	GOLF	<-	1994/1998	MOD. GLX/GTi
C-1558	REPARO DE VEDAÇÃO DA PINÇA 54,00mm	VOLKSWAGEN	GOLF	<-	1995/1998	MOD. GL (Fabr. Alemanha)
C-1558	REPARO DE VEDAÇÃO DA PINÇA 54,00mm	VOLKSWAGEN	PASSAT	<-	1991/1997	MOTOR 2.0 4 CIL.
C-1558	REPARO DE VEDAÇÃO DA PINÇA 54,00mm	VOLKSWAGEN	PASSAT	<-	1998/2005	MOTOR 1.8
C-1558	REPARO DE VEDAÇÃO DA PINÇA 54,00mm	VOLKSWAGEN	PASSAT VARIANT	<-	1991/1997	MOTOR 2.0 4 CIL.
C-1558	REPARO DE VEDAÇÃO DA PINÇA 54,00mm	VOLKSWAGEN	PASSAT VARIANT	<-	1998/2005	MOTOR 1.8
C-1558	REPARO DE VEDAÇÃO DA PINÇA 54,00mm	VOLKSWAGEN	POLO	<-	2002/...	SIST. LUCAS
C-1558	REPARO DE VEDAÇÃO DA PINÇA 54,00mm	VOLKSWAGEN	POLO CLASSIC	<-	1997/2002	
C-1558	REPARO DE VEDAÇÃO DA PINÇA 54,00mm	VOLKSWAGEN	VAN	<-	1999/2002	
C-1558	REPARO DE VEDAÇÃO DA PINÇA 54,00mm	VOLVO	440	<-	1992/1993	SIST. GIRLING
C-1558	REPARO DE VEDAÇÃO DA PINÇA 54,00mm	VOLVO	460	<-	1992/1996	SIST. GIRLING
C-1559	REPARO DE VEDAÇÃO DA PINÇA 48,00mm	GM - CHEVROLET	CORSA	<-	1997/2012	SIST. VARGA
C-1559	REPARO DE VEDAÇÃO DA PINÇA 48,00mm	GM - CHEVROLET	CORSA CLASSIC	<-	2003/...	SIST. VARGA
C-1559	REPARO DE VEDAÇÃO DA PINÇA 48,00mm	GM - CHEVROLET	CORSA PICK-UP	<-	1997/2003	SIST. VARGA
C-1559	REPARO DE VEDAÇÃO DA PINÇA 48,00mm	GM - CHEVROLET	MONTANA	<-	2004/...	
C-1559	REPARO DE VEDAÇÃO DA PINÇA 48,00mm	VOLKSWAGEN	GOL (G2)	<-	1997/2005	SIST. VARGA C/MOTOR 1.0/1.6/1.8 S/ABS
C-1559	REPARO DE VEDAÇÃO DA PINÇA 48,00mm	VOLKSWAGEN	GOL (G3)	<-	2000/2000	SIST. VARGA C/ MOTOR 1.0/1.6/1.8 S/ABS
C-1559	REPARO DE VEDAÇÃO DA PINÇA 48,00mm	VOLKSWAGEN	SAVEIRO (G1)	<-	1997/1997	MOTOR 1.8 SIST. VARGA
C-1565	REPARO DE VEDAÇÃO DA PINÇA 52,00mm	GM - CHEVROLET	ASTRA	<-	1995/1996	
C-1565	REPARO DE VEDAÇÃO DA PINÇA 52,00mm	GM - CHEVROLET	CALIBRA	<-	1993/1995	
C-1565	REPARO DE VEDAÇÃO DA PINÇA 52,00mm	GM - CHEVROLET	VECTRA	<-	1994/1996	
C-1565	REPARO DE VEDAÇÃO DA PINÇA 52,00mm	GM - CHEVROLET	VECTRA	<-	1997/2001	MOTOR 2.0/2.2 8V
C-1565	REPARO DE VEDAÇÃO DA PINÇA 52,00mm	HONDA	FIT	<-	2003/2008	MOTOR 1.4
C-1566	REPARO DO CILINDRO DE RODA 17,78mm	FORD	ESCORT	->	1983/1992	
C-1566	REPARO DO CILINDRO DE RODA 17,78mm	FORD	ESCORT HOBBY	->	1993/1996	
C-1566	REPARO DO CILINDRO DE RODA 17,78mm	FORD	FIESTA	->	1996/2002	MOTOR 1.0/1.3
C-1566	REPARO DO CILINDRO DE RODA 17,78mm	FORD	FIESTA STREET HATCH	->	2001/2007	MOTOR 1.0
C-1566	REPARO DO CILINDRO DE RODA 17,78mm	FORD	KA	->	1997/...	MOTOR 1.0/1.3
C-1566	REPARO DO CILINDRO DE RODA 17,78mm	FORD	VERONA	->	1990/1992	
C-1566	REPARO DO CILINDRO DE RODA 17,78mm	GM - CHEVROLET	CELTA	->	2001/2002	
C-1566	REPARO DO CILINDRO DE RODA 17,78mm	HYUNDAI	ATOS PRIME	->	2000/2003	
C-1566	REPARO DO CILINDRO DE RODA 17,78mm	KIA	CERATO	->	2006/2008	
C-1566	REPARO DO CILINDRO DE RODA 17,78mm	MERCEDES BENZ	CLASSE A	->	1999/2005	
C-1566	REPARO DO CILINDRO DE RODA 17,78mm	RENAULT	CLIO	->	2000/2009	
C-1566	REPARO DO CILINDRO DE RODA 17,78mm	VOLKSWAGEN	APOLLO	->	1990/1992	
C-1567	REPARO DE VEDAÇÃO DA PINÇA 57,00mm	AUDI	100	<-	1993/1995	
C-1567	REPARO DE VEDAÇÃO DA PINÇA 57,00mm	AUDI	100 AVANT	<-	1994/1995	
C-1567	REPARO DE VEDAÇÃO DA PINÇA 57,00mm	AUDI	A4	<-	1995/2008	SIST. ATE
C-1567	REPARO DE VEDAÇÃO DA PINÇA 57,00mm	AUDI	A4 AVANT	<-	1995/2008	SIST. ATE
C-1567	REPARO DE VEDAÇÃO DA PINÇA 57,00mm	AUDI	A6	<-	1994/2011	
C-1567	REPARO DE VEDAÇÃO DA PINÇA 57,00mm	AUDI	A6 AVANT	<-	1994/2011	
C-1567	REPARO DE VEDAÇÃO DA PINÇA 57,00mm	GM - CHEVROLET	ASTRA	<-	1999/2011	MOTOR 2.0 16V
C-1567	REPARO DE VEDAÇÃO DA PINÇA 57,00mm	GM - CHEVROLET	VECTRA	<-	1997/2001	MOTOR 2.0/2.2 16V
C-1567	REPARO DE VEDAÇÃO DA PINÇA 57,00mm	GM - CHEVROLET	ZAFIRA	<-	2002/2012	MOTOR 2.0 16V
C-1567	REPARO DE VEDAÇÃO DA PINÇA 57,00mm	KIA	CLARUS	<-	1997/2000	
C-1567	REPARO DE VEDAÇÃO DA PINÇA 57,00mm	KIA	CLARUS WAGON	<-	1998/2000	

Tabela de Conversão	Polegadas	9/16"	5/8"	11/16"	7/10"	3/4"	13/16"	7/8"	15/16"	1"	1 1/16"	1 1/8"	1 1/4"	1 3/8"	1 1/2"	1 5/8"	1 3/4"	1 7/8"	2"
	Milímetros	14,28mm	15,87mm	17,46mm	17,78mm	19,05mm	20,63mm	22,22mm	23,81mm	25,40mm	26,98mm	28,57mm	31,75mm	34,92mm	38,10mm	41,27mm	44,45mm	46,83mm	50,80mm

PEÇA	DESCRIÇÃO	MARCA	VEÍCULO		ANOS	SOMENTE PARA
C-1567	REPARO DE VEDAÇÃO DA PINÇA 57,00mm	MERCEDES BENZ	CLASSE C	<-	1994/2000	MOD. 200/230K/240
C-1567	REPARO DE VEDAÇÃO DA PINÇA 57,00mm	MERCEDES BENZ	CLASSE E	<-	1995/2002	MOD. 200/200K/230/240/280/320/420
C-1567	REPARO DE VEDAÇÃO DA PINÇA 57,00mm	MERCEDES BENZ	CLASSE E TOURING	<-	1996/2003	MOD. 200/200K/230/240/280/320
C-1567	REPARO DE VEDAÇÃO DA PINÇA 57,00mm	MERCEDES BENZ	CLK	<-	1998/2002	MOD. 200K/230K/320
C-1567	REPARO DE VEDAÇÃO DA PINÇA 57,00mm	MERCEDES BENZ	SLK	<-	2000/2004	MOD. 320/32 AMG
C-1567	REPARO DE VEDAÇÃO DA PINÇA 57,00mm	PEUGEOT	605	<-	1992/2000	MOTOR 3.0 V6
C-1567	REPARO DE VEDAÇÃO DA PINÇA 57,00mm	SAAB	9000	<-	1992/1993	
C-1567	REPARO DE VEDAÇÃO DA PINÇA 57,00mm	TROLLER	T4	<-	2002/...	
C-1567	REPARO DE VEDAÇÃO DA PINÇA 57,00mm	VOLKSWAGEN	CARAVELLE	<-	1998/1999	
C-1567	REPARO DE VEDAÇÃO DA PINÇA 57,00mm	VOLKSWAGEN	EUROVAN	<-	1998/1999	
C-1567	REPARO DE VEDAÇÃO DA PINÇA 57,00mm	VOLKSWAGEN	PASSAT	<-	1998/2005	MOTOR 1.8/1.8 TURBO/2.8 V6
C-1567	REPARO DE VEDAÇÃO DA PINÇA 57,00mm	VOLKSWAGEN	PASSAT VARIANT	<-	1998/2005	MOTOR 1.8/1.8 TURBO/2.8 V6
C-1567	REPARO DE VEDAÇÃO DA PINÇA 57,00mm	VOLVO	850	<-	1992/1997	
C-1567	REPARO DE VEDAÇÃO DA PINÇA 57,00mm	VOLVO	C70	<-	1998/2005	
C-1567	REPARO DE VEDAÇÃO DA PINÇA 57,00mm	VOLVO	S70	<-	1997/2000	
C-1567	REPARO DE VEDAÇÃO DA PINÇA 57,00mm	VOLVO	V70	<-	1997/2000	
C-1568	REPARO DE VEDAÇÃO DA PINÇA 54,00mm	FORD	ROYALE	<-	1995/1996	SIST. VARGA
C-1568	REPARO DE VEDAÇÃO DA PINÇA 54,00mm	FORD	VERSAILLES	<-	1995/1996	SIST. VARGA
C-1568	REPARO DE VEDAÇÃO DA PINÇA 54,00mm	GM - CHEVROLET	IPANEMA	<-	1997/1998	
C-1568	REPARO DE VEDAÇÃO DA PINÇA 54,00mm	GM - CHEVROLET	KADETT	<-	1997/1998	
C-1568	REPARO DE VEDAÇÃO DA PINÇA 54,00mm	HONDA	CIVIC	<-	1997/2000	SIST. VARGA
C-1568	REPARO DE VEDAÇÃO DA PINÇA 54,00mm	VOLKSWAGEN	GOL (G2)	<-	1995/2000	SIST. VARGA C/MOTOR 2.0
C-1568	REPARO DE VEDAÇÃO DA PINÇA 54,00mm	VOLKSWAGEN	GOL (G2)	<-	1995/2000	SIST. VARGA C/ABS
C-1568	REPARO DE VEDAÇÃO DA PINÇA 54,00mm	VOLKSWAGEN	GOL (G3)	<-	2000/2000	SIST. VARGA C/ MOTOR 2.0
C-1568	REPARO DE VEDAÇÃO DA PINÇA 54,00mm	VOLKSWAGEN	GOL (G3)	<-	2000/2000	SIST. VARGA C/ABS
C-1568	REPARO DE VEDAÇÃO DA PINÇA 54,00mm	VOLKSWAGEN	GOL (G3)	<-	2001/2005	SIST. VARGA
C-1568	REPARO DE VEDAÇÃO DA PINÇA 54,00mm	VOLKSWAGEN	GOL (G4)	<-	2006/...	SIST. VARGA
C-1568	REPARO DE VEDAÇÃO DA PINÇA 54,00mm	VOLKSWAGEN	PARATI (G2, G3 e G4)	<-	1996/2012	SIST. VARGA
C-1568	REPARO DE VEDAÇÃO DA PINÇA 54,00mm	VOLKSWAGEN	QUANTUM	<-	1995/2002	SIST. VARGA
C-1568	REPARO DE VEDAÇÃO DA PINÇA 54,00mm	VOLKSWAGEN	SANTANA	<-	1995/2006	SIST. VARGA
C-1568	REPARO DE VEDAÇÃO DA PINÇA 54,00mm	VOLKSWAGEN	SAVEIRO (G2, G3 e G4)	<-	1998/2009	SIST. VARGA
C-1569	REPARO DO CILINDRO DE RODA 23,81mm	TOYOTA	BANDEIRANTE	->	1995/2001	C/ <-
C-1570	REPARO DO CILINDRO DE RODA 22,22mm	TOYOTA	HILUX PICK-UP	->	1992/2005	4X4
C-1570	REPARO DO CILINDRO DE RODA 22,22mm	TOYOTA	HILUX SW4	->	1992/1995	
C-1571	REPARO DO CILINDRO DE RODA 17,46mm	HYUNDAI	HR	->	2005/...	
C-1571	REPARO DO CILINDRO DE RODA 17,46mm	KIA	BESTA	->	1993/1998	MOD. 2.2/2.7
C-1571	REPARO DO CILINDRO DE RODA 17,46mm	KIA	BONGO	->	1993/1997	K-2400
C-1572	REPARO DO CILINDRO DE RODA 17,46mm	ASIA	TOWNER	->	1993/1999	
C-1573	REPARO DO CILINDRO DE RODA 19,05mm	ASIA	ROCSTA	->	1994/1995	
C-1573	REPARO DO CILINDRO DE RODA 19,05mm	ASIA	TOPIC	->	1993/1999	
C-1574	REPARO DO CILINDRO DE RODA 25,40mm	MERCEDES BENZ	MB-180	->	1994/1996	
C-1575	REPARO DE VEDAÇÃO DA PINÇA 54,00mm	FORD	ESCORT	<-	1993/2003	SIST. BOSCH
C-1575	REPARO DE VEDAÇÃO DA PINÇA 54,00mm	FORD	ESCORT SW	<-	1997/2003	
C-1575	REPARO DE VEDAÇÃO DA PINÇA 54,00mm	FORD	VERONA	<-	1994/1996	SIST. BOSCH
C-1575	REPARO DE VEDAÇÃO DA PINÇA 54,00mm	VOLKSWAGEN	LOGUS	<-	1993/1996	SIST. BOSCH
C-1575	REPARO DE VEDAÇÃO DA PINÇA 54,00mm	VOLKSWAGEN	POINTER	<-	1994/1996	SIST. BOSCH
C-1576	REPARO DE VEDAÇÃO DA PINÇA 52,00mm	MERCEDES BENZ	MB-180	<-	1994/1996	
C-1577	REPARO DE VEDAÇÃO DA PINÇA 44,00mm	MERCEDES BENZ	SPRINTER	<-	1997/...	
C-1578	REPARO DO CILINDRO DE RODA 20,63mm	CITROËN	XSARA	->	1998/2003	SIST. LUCAS C/ABS
C-1578	REPARO DO CILINDRO DE RODA 20,63mm	CITROËN	ZX	->	1995/1998	C/ABS
C-1578	REPARO DO CILINDRO DE RODA 20,63mm	FIAT	GRAND SIENA	->	2012/...	
C-1578	REPARO DO CILINDRO DE RODA 20,63mm	FIAT	PALIO	->	2012/...	SIST. TRW
C-1578	REPARO DO CILINDRO DE RODA 20,63mm	FIAT	PALIO WEEKEND	->	2009/...	SIST. TRW
C-1578	REPARO DO CILINDRO DE RODA 20,63mm	FIAT	PUNTO	->	2008/...	
C-1578	REPARO DO CILINDRO DE RODA 20,63mm	FORD	ESCORT	->	1997/2003	
C-1578	REPARO DO CILINDRO DE RODA 20,63mm	FORD	ESCORT SW	->	1997/2003	
C-1578	REPARO DO CILINDRO DE RODA 20,63mm	FORD	FOCUS	->	2001/2005	MOTOR 1.8/2.0 16V
C-1578	REPARO DO CILINDRO DE RODA 20,63mm	FORD	MONDEO	->	1994/2001	C/ FREIO 9"
C-1578	REPARO DO CILINDRO DE RODA 20,63mm	HYUNDAI	H-100	->	2000/2004	
C-1578	REPARO DO CILINDRO DE RODA 20,63mm	PEUGEOT	106	->	1997/1998	C/ABS
C-1578	REPARO DO CILINDRO DE RODA 20,63mm	PEUGEOT	306	->	1994/2002	SIST. LUCAS C/ABS
C-1578	REPARO DO CILINDRO DE RODA 20,63mm	RENAULT	LAGUNA	->	1999/2001	

Tabela de Conversão	Polegadas	9/16"	5/8"	11/16"	7/10"	3/4"	13/16"	7/8"	15/16"	1"	1 1/16"	1 1/8"	1 1/4"	1 3/8"	1 1/2"	1 5/8"	1 3/4"	1 27/32"	2"
	Milímetros	14,28mm	15,87mm	17,46mm	17,78mm	19,05mm	20,63mm	22,22mm	23,81mm	25,40mm	26,98mm	28,57mm	31,75mm	34,92mm	38,10mm	41,27mm	44,45mm	46,83mm	50,80mm



PEÇA	DESCRIÇÃO	MARCA	VEÍCULO		ANOS	SOMENTE PARA
C-1578	REPARO DO CILINDRO DE RODA 20,63mm	RENAULT	LAGUNA NEVADA	->	1995/1998	
C-1578	REPARO DO CILINDRO DE RODA 20,63mm	RENAULT	SCENIC	->	1999/2011	
C-1579	REPARO DO CILINDRO DE RODA 23,81mm	GM - CHEVROLET	SPACE VAN	->	1997/1999	
C-1579	REPARO DO CILINDRO DE RODA 23,81mm	GM - CHEVROLET	TRAFIC	->	1992/1998	
C-1579	REPARO DO CILINDRO DE RODA 23,81mm	RENAULT	TRAFIC	->	1992/2003	
C-1580	REPARO DO CILINDRO DE RODA 22,00mm	RENAULT	19	->	1992/1998	MOD. RV/RT SIST. VARGA
C-1580	REPARO DO CILINDRO DE RODA 22,00mm	RENAULT	CLIO	->	1996/1999	
C-1581	REPARO DO CILINDRO DE RODA 20,63mm	FORD	RANGER	->	1998/2012	C/ FREIO 11"
C-1581	REPARO DO CILINDRO DE RODA 20,63mm	MERCEDES BENZ	SPRINTER	->	1997/2000	
C-1582	REPARO DO CILINDRO DE RODA 22,22mm	CITROËN	BERLINGO	->	1998/2007	
C-1582	REPARO DO CILINDRO DE RODA 22,22mm	CITROËN	XSARA PICASSO	->	2001/2012	
C-1582	REPARO DO CILINDRO DE RODA 22,22mm	FORD	COURIER	->	1998/...	
C-1582	REPARO DO CILINDRO DE RODA 22,22mm	FORD	ECOSPORT	->	2004/2012	4X4
C-1582	REPARO DO CILINDRO DE RODA 22,22mm	FORD	MONDEO	->	1994/1996	C/ FREIO 8"
C-1582	REPARO DO CILINDRO DE RODA 22,22mm	FORD	MONDEO SW	->	1994/2001	
C-1582	REPARO DO CILINDRO DE RODA 22,22mm	PEUGEOT	504 PICK-UP	->	1992/1999	SIST. GIRLING
C-1582	REPARO DO CILINDRO DE RODA 22,22mm	PEUGEOT	HOGGAR	->	2010/...	
C-1582	REPARO DO CILINDRO DE RODA 22,22mm	PEUGEOT	PARTNER	->	1999/...	
C-1582	REPARO DO CILINDRO DE RODA 22,22mm	RENAULT	21	->	1992/1994	SIST. LUCAS
C-1582	REPARO DO CILINDRO DE RODA 22,22mm	RENAULT	21 NEVADA	->	1993/1994	SIST. LUCAS
C-1582	REPARO DO CILINDRO DE RODA 22,22mm	RENAULT	EXPRESS	->	1998/2000	
C-1582	REPARO DO CILINDRO DE RODA 22,22mm	TOYOTA	HILUX PICK-UP	->	2006/...	
C-1582	REPARO DO CILINDRO DE RODA 22,22mm	TOYOTA	HILUX SW4	->	2006/...	
C-1583	REPARO DO CILINDRO DE RODA 20,63mm	VOLKSWAGEN	PARATI (G2, G3 e G4)	->	2001/2012	S/ABS
C-1583	REPARO DO CILINDRO DE RODA 20,63mm	VOLKSWAGEN	SAVEIRO (G2, G3 e G4)	->	1998/2009	
C-1585	REPARO DE VEDAÇÃO DA PINÇA 60,50mm	ASIA	TOPIC	<-	1993/1999	
C-1586	REPARO DE VEDAÇÃO DA PINÇA 51,00mm	ASIA	TOWNER	<-	1993/1999	
C-1587	REPARO DE VEDAÇÃO DA PINÇA 54,00mm	ALFA ROMEO	147	<-	2003/2006	
C-1587	REPARO DE VEDAÇÃO DA PINÇA 54,00mm	ALFA ROMEO	156	<-	1999/2003	
C-1587	REPARO DE VEDAÇÃO DA PINÇA 54,00mm	ALFA ROMEO	156 SPORTWAGON	<-	2001/2004	
C-1587	REPARO DE VEDAÇÃO DA PINÇA 54,00mm	AUDI	A3	<-	1997/...	
C-1587	REPARO DE VEDAÇÃO DA PINÇA 54,00mm	AUDI	A3 SPORTBACK	<-	2007/...	
C-1587	REPARO DE VEDAÇÃO DA PINÇA 54,00mm	AUDI	TT	<-	1999/2006	
C-1587	REPARO DE VEDAÇÃO DA PINÇA 54,00mm	BMW	SÉRIE 3	<-	1991/2005	
C-1587	REPARO DE VEDAÇÃO DA PINÇA 54,00mm	BMW	Z3	<-	1995/2003	
C-1587	REPARO DE VEDAÇÃO DA PINÇA 54,00mm	KIA	SEPHIA	<-	1993/2001	
C-1587	REPARO DE VEDAÇÃO DA PINÇA 54,00mm	KIA	SHUMA	<-	1998/2000	
C-1587	REPARO DE VEDAÇÃO DA PINÇA 54,00mm	PORSCHE	928	<-	1992/1995	
C-1587	REPARO DE VEDAÇÃO DA PINÇA 54,00mm	VOLKSWAGEN	BORA	<-	2001/2011	
C-1587	REPARO DE VEDAÇÃO DA PINÇA 54,00mm	VOLKSWAGEN	CROSSFOX	<-	2005/...	
C-1587	REPARO DE VEDAÇÃO DA PINÇA 54,00mm	VOLKSWAGEN	EOS	<-	2008/2012	
C-1587	REPARO DE VEDAÇÃO DA PINÇA 54,00mm	VOLKSWAGEN	FOX	<-	2004/...	MOTOR 1.6
C-1587	REPARO DE VEDAÇÃO DA PINÇA 54,00mm	VOLKSWAGEN	FOX	<-	2004/...	MOTOR 1.0 C/ DISCO 256x22mm
C-1587	REPARO DE VEDAÇÃO DA PINÇA 54,00mm	VOLKSWAGEN	GOLF	<-	1999/...	
C-1587	REPARO DE VEDAÇÃO DA PINÇA 54,00mm	VOLKSWAGEN	NEW BEETLE	<-	2000/2010	
C-1587	REPARO DE VEDAÇÃO DA PINÇA 54,00mm	VOLKSWAGEN	PASSAT	<-	1991/1997	MOTOR 2.8 V6
C-1587	REPARO DE VEDAÇÃO DA PINÇA 54,00mm	VOLKSWAGEN	PASSAT VARIANT	<-	1991/1997	MOTOR 2.8 V6
C-1587	REPARO DE VEDAÇÃO DA PINÇA 54,00mm	VOLKSWAGEN	SPACEFOX	<-	2006/...	
C-1587	REPARO DE VEDAÇÃO DA PINÇA 54,00mm	VOLKSWAGEN	SPACE CROSS	<-	2012/...	
C-1587	REPARO DE VEDAÇÃO DA PINÇA 54,00mm	VOLVO	440	<-	1992/1993	SIST. ATE
C-1587	REPARO DE VEDAÇÃO DA PINÇA 54,00mm	VOLVO	460	<-	1992/1996	SIST. ATE
C-1588	REPARO DE VEDAÇÃO DA PINÇA 60,50mm	KIA	BESTA	<-	1993/1998	MOD. 2.2/2.7
C-1589	REPARO DE VEDAÇÃO DA PINÇA 46,00mm	KIA	BESTA	<-	1998/2005	MOD. GS
C-1590	REPARO DO CILINDRO DE RODA 17,46mm	RENAULT	MEGANE	->	1997/2005	
C-1591	REPARO DO CILINDRO DE RODA 19,00mm	RENAULT	19	->	1992/1998	MOD. RT SIST. BENDIX 8"
C-1592	REPARO DE VEDAÇÃO DA PINÇA 46,00mm	AGRALE	MARRUÁ	<-	2005/...	
C-1592	REPARO DE VEDAÇÃO DA PINÇA 46,00mm	FORD	EXPLORER	<-	1995/2005	
C-1592	REPARO DE VEDAÇÃO DA PINÇA 46,00mm	FORD	RANGER	<-	1995/2012	
C-1593	REPARO DO CILINDRO DE RODA 20,63mm	AUDI	80	->	1993/1994	MOTOR 2.0 8V S/ABS
C-1593	REPARO DO CILINDRO DE RODA 20,63mm	AUDI	80 AVANT	->	1993/1994	MOTOR 2.0 8V S/ABS
C-1593	REPARO DO CILINDRO DE RODA 20,63mm	SEAT	INCA	->	1999/2002	
C-1593	REPARO DO CILINDRO DE RODA 20,63mm	VOLKSWAGEN	SAVEIRO (G5)	->	2010/...	1KM

Tabela de Conversão	Polegadas	9/16"	5/8"	11/16"	7/10"	3/4"	13/16"	7/8"	15/16"	1"	1 1/16"	1 1/8"	1 1/4"	1 3/8"	1 1/2"	1 5/8"	1 3/4"	1 27/32"	2"
	Milímetros		14,28mm	15,87mm	17,46mm	17,78mm	19,05mm	20,63mm	22,22mm	23,81mm	25,40mm	26,98mm	28,57mm	31,75mm	34,92mm	38,10mm	41,27mm	44,45mm	46,83mm

PEÇA	DESCRIÇÃO	MARCA	VEÍCULO		ANOS	SOMENTE PARA
C-1593	REPARO DO CILINDRO DE RODA 20,63mm	VOLKSWAGEN	VAN	->	1999/2002	
C-1594	REPARO DO CILINDRO DE RODA 19,05mm	HONDA	ACCORD	->	1991/1993	
C-1594	REPARO DO CILINDRO DE RODA 19,05mm	HONDA	CIVIC	->	1992/2000	
C-1595	REPARO DO CILINDRO DE RODA 23,81mm	TOYOTA	HILUX SW4	->	1996/2000	C/ ARO 15"
C-1596	REPARO DO CILINDRO DE RODA 17,46mm	TOYOTA	COROLLA	->	1992/1998	
C-1596	REPARO DO CILINDRO DE RODA 17,46mm	TOYOTA	PASEO	->	1992/1995	
C-1597	REPARO DO CILINDRO DE RODA 26,98mm	CITROËN	JUMPER	->	1996/2002	
C-1597	REPARO DO CILINDRO DE RODA 26,98mm	FIAT	UCATO	->	1998/1998	10/15 LUGARES
C-1597	REPARO DO CILINDRO DE RODA 26,98mm	FIAT	UCATO	->	1999/2002	15/COMBINATO/MINIBUS
C-1597	REPARO DO CILINDRO DE RODA 26,98mm	PEUGEOT	BOXER	->	1998/2002	
C-1598	REPARO DE VEDAÇÃO DA PINÇA 54,00mm	VOLKSWAGEN	KOMBI	<-	1997/...	SIST. VARGA
C-1599	REPARO DE VEDAÇÃO DA PINÇA 54,00mm	FORD	F-250	<-	1999/2012	
C-1599	REPARO DE VEDAÇÃO DA PINÇA 54,00mm	FORD - CAMINHÕES	F-350	<-	1999/2012	
C-1599	REPARO DE VEDAÇÃO DA PINÇA 54,00mm	FORD - CAMINHÕES	F-350	->	1999/2012	
C-1599	REPARO DE VEDAÇÃO DA PINÇA 54,00mm	FORD - CAMINHÕES	F-4000	<-	1999/2012	
C-1599	REPARO DE VEDAÇÃO DA PINÇA 54,00mm	FORD - CAMINHÕES	F-4000	->	1999/2012	
C-1601	REPARO DO CIL. MESTRE DE EMBREAGEM 26,98mm	FORD	F-100		1962/1971	
C-1601	REPARO DO CIL. MESTRE DE EMBREAGEM 26,98mm	FORD - CAMINHÕES	F-350		1962/1971	
C-1601	REPARO DO CIL. MESTRE DE EMBREAGEM 26,98mm	FORD - CAMINHÕES	F-600		1962/1971	
C-1602	REPARO DO CIL. AUXILIAR DE EMBREAGEM 25,40mm	FORD	F-100		1962/1971	
C-1602	REPARO DO CIL. AUXILIAR DE EMBREAGEM 25,40mm	FORD - CAMINHÕES	F-350		1962/1971	
C-1602	REPARO DO CIL. AUXILIAR DE EMBREAGEM 25,40mm	FORD - CAMINHÕES	F-600		1962/1971	
C-1603	REPARO DO CIL. MESTRE DE EMBREAGEM 25,40mm	TOYOTA	BANDEIRANTE		1966/1978	
C-1604	REPARO DO CIL. AUXILIAR DE EMBREAGEM 22,22mm	TOYOTA	BANDEIRANTE		1966/1994	
C-1604	REPARO DO CIL. AUXILIAR DE EMBREAGEM 22,22mm	TROLLER	T4		2002/...	
C-1610	REPARO DO CIL. MESTRE DE EMBREAGEM 28,57mm	FIAT - CAMINHÕES	100		1977/1985	
C-1610	REPARO DO CIL. MESTRE DE EMBREAGEM 28,57mm	FIAT - CAMINHÕES	140/150/180		1977/1985	
C-1610	REPARO DO CIL. MESTRE DE EMBREAGEM 28,57mm	FIAT - CAMINHÕES	190		1975/1985	
C-1610	REPARO DO CIL. MESTRE DE EMBREAGEM 28,57mm	FIAT - CAMINHÕES	210/211		1975/1978	
C-1610	REPARO DO CIL. MESTRE DE EMBREAGEM 28,57mm	FORD - CAMINHÕES	FB-4000		1982/1985	
C-1611	REPARO DO CIL. AUXILIAR DE EMBREAGEM 28,57mm	FORD - CAMINHÕES	FB-4000		1982/1985	
C-1612	REPARO DO CIL. MESTRE DE EMBREAGEM 19,05mm	VOLKSWAGEN - CAMINHÕES	Jun-80		1982/1986	
C-1612	REPARO DO CIL. MESTRE DE EMBREAGEM 19,05mm	VOLKSWAGEN - CAMINHÕES	Jun-90		1982/1986	
C-1612	REPARO DO CIL. MESTRE DE EMBREAGEM 19,05mm	VOLKSWAGEN - CAMINHÕES	Jul-90		1987/1994	
C-1612	REPARO DO CIL. MESTRE DE EMBREAGEM 19,05mm	VOLKSWAGEN - CAMINHÕES	7-110 S		1988/1994	
C-1612	REPARO DO CIL. MESTRE DE EMBREAGEM 19,05mm	VOLKSWAGEN - CAMINHÕES	11-130		1982/1985	
C-1612	REPARO DO CIL. MESTRE DE EMBREAGEM 19,05mm	VOLKSWAGEN - CAMINHÕES	11-140		1982/1993	
C-1612	REPARO DO CIL. MESTRE DE EMBREAGEM 19,05mm	VOLKSWAGEN - CAMINHÕES	11-160		1986/1993	
C-1612	REPARO DO CIL. MESTRE DE EMBREAGEM 19,05mm	VOLKSWAGEN - CAMINHÕES	12-140		1982/2000	
C-1612	REPARO DO CIL. MESTRE DE EMBREAGEM 19,05mm	VOLKSWAGEN - CAMINHÕES	13-130		1981/1986	
C-1612	REPARO DO CIL. MESTRE DE EMBREAGEM 19,05mm	VOLKSWAGEN - CAMINHÕES	14-140		1982/1991	
C-1612	REPARO DO CIL. MESTRE DE EMBREAGEM 19,05mm	VOLKSWAGEN - CAMINHÕES	22-160		1986/1989	
C-1613	REPARO DO CIL. AUXILIAR DE EMBREAGEM 22,22mm	VOLKSWAGEN - CAMINHÕES	Jun-80		1982/1986	
C-1613	REPARO DO CIL. AUXILIAR DE EMBREAGEM 22,22mm	VOLKSWAGEN - CAMINHÕES	Jun-90		1982/1986	
C-1613	REPARO DO CIL. AUXILIAR DE EMBREAGEM 22,22mm	VOLKSWAGEN - CAMINHÕES	Jul-90		1987/1994	
C-1613	REPARO DO CIL. AUXILIAR DE EMBREAGEM 22,22mm	VOLKSWAGEN - CAMINHÕES	7-110 S		1988/1994	
C-1613	REPARO DO CIL. AUXILIAR DE EMBREAGEM 22,22mm	VOLKSWAGEN - CAMINHÕES	11-130		1982/1985	
C-1613	REPARO DO CIL. AUXILIAR DE EMBREAGEM 22,22mm	VOLKSWAGEN - CAMINHÕES	11-140		1982/1993	
C-1613	REPARO DO CIL. AUXILIAR DE EMBREAGEM 22,22mm	VOLKSWAGEN - CAMINHÕES	11-160		1986/1993	
C-1613	REPARO DO CIL. AUXILIAR DE EMBREAGEM 22,22mm	VOLKSWAGEN - CAMINHÕES	12-140		1982/2000	
C-1613	REPARO DO CIL. AUXILIAR DE EMBREAGEM 22,22mm	VOLKSWAGEN - CAMINHÕES	13-130		1981/1986	
C-1613	REPARO DO CIL. AUXILIAR DE EMBREAGEM 22,22mm	VOLKSWAGEN - CAMINHÕES	14-140		1982/1991	
C-1613	REPARO DO CIL. AUXILIAR DE EMBREAGEM 22,22mm	VOLKSWAGEN - CAMINHÕES	22-160		1986/1989	
C-1614	REPARO DO CIL. MESTRE DE EMBREAGEM 22,22mm	TOYOTA	BANDEIRANTE		1979/1986	
C-1615	REPARO DO CIL. MESTRE DE EMBREAGEM 23,81mm	MERCEDES BENZ - CAMINHÕES	0-370		1984/...	
C-1615	REPARO DO CIL. MESTRE DE EMBREAGEM 23,81mm	MERCEDES BENZ - CAMINHÕES	0-371		1984/...	
C-1615	REPARO DO CIL. MESTRE DE EMBREAGEM 23,81mm	MERCEDES BENZ - CAMINHÕES	L/OH-1316		1970/1989	
C-1615	REPARO DO CIL. MESTRE DE EMBREAGEM 23,81mm	MERCEDES BENZ - CAMINHÕES	OH-1317		1970/1989	
C-1615	REPARO DO CIL. MESTRE DE EMBREAGEM 23,81mm	MERCEDES BENZ - CAMINHÕES	OF/OH-1318		1987/...	
C-1616	REPARO DO CIL. AUXILIAR DE EMBREAGEM 38,10mm	MERCEDES BENZ - CAMINHÕES	0-370		1984/...	
C-1616	REPARO DO CIL. AUXILIAR DE EMBREAGEM 38,10mm	MERCEDES BENZ - CAMINHÕES	0-371		1984/...	
C-1616	REPARO DO CIL. AUXILIAR DE EMBREAGEM 38,10mm	MERCEDES BENZ - CAMINHÕES	L/LK/LP-1214		1989/...	

Tabela de Conversão	Polegadas	9/16"	5/8"	11/16"	7/10"	3/4"	13/16"	7/8"	15/16"	1"	1 1/16"	1 1/8"	1 1/4"	1 3/8"	1 1/2"	1 5/8"	1 3/4"	1 27/32"	2"
	Milímetros	14,28mm	15,87mm	17,46mm	17,78mm	19,05mm	20,63mm	22,22mm	23,81mm	25,40mm	26,98mm	28,57mm	31,75mm	34,92mm	38,10mm	41,27mm	44,45mm	46,83mm	50,80mm

PEÇA	DESCRIÇÃO	MARCA	VEÍCULO		ANOS	SOMENTE PARA
C-1616	REPARO DO CIL. AUXILIAR DE EMBREAGEM 38,10mm	MERCEDES BENZ - CAMINHÕES	L/OH-1316		1970/1989	
C-1616	REPARO DO CIL. AUXILIAR DE EMBREAGEM 38,10mm	MERCEDES BENZ - CAMINHÕES	OH-1317		1970/1989	
C-1616	REPARO DO CIL. AUXILIAR DE EMBREAGEM 38,10mm	MERCEDES BENZ - CAMINHÕES	OF/OH-1318		1987/...	
C-1616	REPARO DO CIL. AUXILIAR DE EMBREAGEM 38,10mm	MERCEDES BENZ - CAMINHÕES	L/LP/OH-1419		1980/...	
C-1616	REPARO DO CIL. AUXILIAR DE EMBREAGEM 38,10mm	MERCEDES BENZ - CAMINHÕES	OH-1420		1980/...	
C-1616	REPARO DO CIL. AUXILIAR DE EMBREAGEM 38,10mm	MERCEDES BENZ - CAMINHÕES	L/LP-1614		1989/...	
C-1616	REPARO DO CIL. AUXILIAR DE EMBREAGEM 38,10mm	MERCEDES BENZ - CAMINHÕES	L/LK-1618		1989/...	
C-1616	REPARO DO CIL. AUXILIAR DE EMBREAGEM 38,10mm	MERCEDES BENZ - CAMINHÕES	L/LS-1625		1991/...	
C-1616	REPARO DO CIL. AUXILIAR DE EMBREAGEM 38,10mm	MERCEDES BENZ - CAMINHÕES	L-1714		1991/...	
C-1617	REPARO DO CIL. MESTRE DE EMBREAGEM 19,05mm	MERCEDES BENZ - CAMINHÕES	L/LO-608 D/E		1976/1986	
C-1617	REPARO DO CIL. MESTRE DE EMBREAGEM 19,05mm	MERCEDES BENZ - CAMINHÕES	L/LO-708 D/E		1987/1988	
C-1617	REPARO DO CIL. MESTRE DE EMBREAGEM 19,05mm	MERCEDES BENZ - CAMINHÕES	L/LS/LK-1935		1990/1991	
C-1618	REPARO DO CIL. AUXILIAR DE EMBREAGEM 28,57mm	MERCEDES BENZ - CAMINHÕES	L/LO-608 D/E		1976/1986	
C-1618	REPARO DO CIL. AUXILIAR DE EMBREAGEM 28,57mm	MERCEDES BENZ - CAMINHÕES	L/LO-708 D/E		1987/1988	
C-1621	REPARO DO CIL. AUXILIAR DE EMBREAGEM 28,57mm	MERCEDES BENZ - CAMINHÕES	L-709		1989/1996	
C-1621	REPARO DO CIL. AUXILIAR DE EMBREAGEM 28,57mm	MERCEDES BENZ - CAMINHÕES	L-710		1996/...	
C-1621	REPARO DO CIL. AUXILIAR DE EMBREAGEM 28,57mm	MERCEDES BENZ - CAMINHÕES	LO/OF-809		1989/...	
C-1621	REPARO DO CIL. AUXILIAR DE EMBREAGEM 28,57mm	MERCEDES BENZ - CAMINHÕES	L/LO/OF-812		1989/...	
C-1621	REPARO DO CIL. AUXILIAR DE EMBREAGEM 28,57mm	MERCEDES BENZ - CAMINHÕES	L/LO-912		1989/...	
C-1621	REPARO DO CIL. AUXILIAR DE EMBREAGEM 28,57mm	MERCEDES BENZ - CAMINHÕES	OF-1620		1992/...	
C-1621	REPARO DO CIL. AUXILIAR DE EMBREAGEM 28,57mm	MERCEDES BENZ - CAMINHÕES	LS-1630/1635		1991/...	
C-1621	REPARO DO CIL. AUXILIAR DE EMBREAGEM 28,57mm	MERCEDES BENZ - CAMINHÕES	LS-1938		1991/...	
C-1621	REPARO DO CIL. AUXILIAR DE EMBREAGEM 28,57mm	MERCEDES BENZ - CAMINHÕES	L/LS/LK-1941		1991/1991	MOD. L/LS
C-1623	REPARO DO CIL. MESTRE DE EMBREAGEM 22,22mm	FORD - CAMINHÕES	CARGO		1985/...	
C-1623	REPARO DO CIL. MESTRE DE EMBREAGEM 22,22mm	TOYOTA	BANDEIRANTE		1987/1994	
C-1623	REPARO DO CIL. MESTRE DE EMBREAGEM 22,22mm	TROLLER	T4		2002/...	
C-1624	REPARO DO CIL. MESTRE DE EMBREAGEM 20,63mm	AGRALE	MA 12.0		2004/...	
C-1624	REPARO DO CIL. MESTRE DE EMBREAGEM 20,63mm	MERCEDES BENZ - CAMINHÕES	L/LS/LK-1929		1992/...	
C-1624	REPARO DO CIL. MESTRE DE EMBREAGEM 20,63mm	MERCEDES BENZ - CAMINHÕES	L/LS/LK-1935		1992/...	
C-1624	REPARO DO CIL. MESTRE DE EMBREAGEM 20,63mm	MERCEDES BENZ - CAMINHÕES	L/LS/LK-1941		1992/...	
C-1625	REPARO DO CIL. MESTRE DE EMBREAGEM 20,63mm	MERCEDES BENZ - CAMINHÕES	0-400 R/RS/RSD/RSL/UP		1992/...	
C-1626	REPARO DO CIL. MESTRE DE EMBREAGEM 19,05mm	MERCEDES BENZ - CAMINHÕES	0-370		1984/...	MOD. R/RS
C-1626	REPARO DO CIL. MESTRE DE EMBREAGEM 19,05mm	MERCEDES BENZ - CAMINHÕES	L/LS-1932/1933/1934		1984/...	MOD. L/LS
C-1627	REPARO DO CIL. MESTRE DE EMBREAGEM 19,05mm	MERCEDES BENZ - CAMINHÕES	L-709		1989/1996	
C-1627	REPARO DO CIL. MESTRE DE EMBREAGEM 19,05mm	MERCEDES BENZ - CAMINHÕES	L-710		1996/...	
C-1627	REPARO DO CIL. MESTRE DE EMBREAGEM 19,05mm	MERCEDES BENZ - CAMINHÕES	LO/OF-809		1989/...	
C-1627	REPARO DO CIL. MESTRE DE EMBREAGEM 19,05mm	MERCEDES BENZ - CAMINHÕES	L/LO/OF-812		1989/...	
C-1627	REPARO DO CIL. MESTRE DE EMBREAGEM 19,05mm	MERCEDES BENZ - CAMINHÕES	L/LO-912		1989/...	
C-1627	REPARO DO CIL. MESTRE DE EMBREAGEM 19,05mm	MERCEDES BENZ - CAMINHÕES	LS-1630/1635		1991/...	
C-1627	REPARO DO CIL. MESTRE DE EMBREAGEM 19,05mm	MERCEDES BENZ - CAMINHÕES	L/LS/LK-1929		1991/...	MOD. L/LS
C-1627	REPARO DO CIL. MESTRE DE EMBREAGEM 19,05mm	MERCEDES BENZ - CAMINHÕES	L/LS/LK-1935		1991/...	MOD. L/LS
C-1627	REPARO DO CIL. MESTRE DE EMBREAGEM 19,05mm	MERCEDES BENZ - CAMINHÕES	LS-1938		1991/...	
C-1627	REPARO DO CIL. MESTRE DE EMBREAGEM 19,05mm	MERCEDES BENZ - CAMINHÕES	L/LS/LK-1941		1991/...	MOD. L/LS
C-1628	REPARO DO CIL. AUXILIAR DE EMBREAGEM 38,10mm	MERCEDES BENZ - CAMINHÕES	L/LK/LS-1621		1989/...	
C-1629	REPARO DO CIL. MESTRE DE EMBREAGEM 23,81mm	MERCEDES BENZ - CAMINHÕES	0-371		1987/...	
C-1629	REPARO DO CIL. MESTRE DE EMBREAGEM 23,81mm	MERCEDES BENZ - CAMINHÕES	L/LP/OH-1419		1980/...	
C-1629	REPARO DO CIL. MESTRE DE EMBREAGEM 23,81mm	MERCEDES BENZ - CAMINHÕES	OH-1420		1980/...	
C-1629	REPARO DO CIL. MESTRE DE EMBREAGEM 23,81mm	MERCEDES BENZ - CAMINHÕES	L/LP-1614		1989/...	
C-1629	REPARO DO CIL. MESTRE DE EMBREAGEM 23,81mm	MERCEDES BENZ - CAMINHÕES	L/LK-1618		1989/...	
C-1630	REPARO DO CIL. AUXILIAR DE EMBREAGEM 22,22mm	AGRALE	4500/5000		1994/1998	
C-1630	REPARO DO CIL. AUXILIAR DE EMBREAGEM 22,22mm	AGRALE	6000		1999/...	
C-1630	REPARO DO CIL. AUXILIAR DE EMBREAGEM 22,22mm	AGRALE	7000/7500		1993/2005	
C-1630	REPARO DO CIL. AUXILIAR DE EMBREAGEM 22,22mm	AGRALE	8500		1997/...	
C-1630	REPARO DO CIL. AUXILIAR DE EMBREAGEM 22,22mm	AGRALE	9200 TCA		2003/...	
C-1630	REPARO DO CIL. AUXILIAR DE EMBREAGEM 22,22mm	AGRALE	FURGOVAN		2002/...	
C-1630	REPARO DO CIL. AUXILIAR DE EMBREAGEM 22,22mm	AGRALE	MA 5.0/6.0/7.5/8.0/8.5/9.2		1996/...	
C-1630	REPARO DO CIL. AUXILIAR DE EMBREAGEM 22,22mm	AGRALE	VOLARE A5/V5		2002/2007	
C-1630	REPARO DO CIL. AUXILIAR DE EMBREAGEM 22,22mm	AGRALE	VOLARE A6/V6		1998/2007	
C-1630	REPARO DO CIL. AUXILIAR DE EMBREAGEM 22,22mm	AGRALE	VOLARE A8/V8		2000/2007	
C-1630	REPARO DO CIL. AUXILIAR DE EMBREAGEM 22,22mm	AGRALE	VOLARE W8		2002/2007	
C-1630	REPARO DO CIL. AUXILIAR DE EMBREAGEM 22,22mm	AGRALE	VOLARE W9		2006/2007	
C-1630	REPARO DO CIL. AUXILIAR DE EMBREAGEM 22,22mm	FORD	F-1000		1998/1998	MOTOR MWM 4.3 DIESEL

Polgadas	9/16"	5/8"	11/16"	7/10"	3/4"	13/16"	7/8"	15/16"	1"	1 1/16"	1 1/8"	1 1/4"	1 3/8"	1 1/2"	1 5/8"	1 3/4"	1 27/32"	2"
Milímetros	14,28mm	15,87mm	17,46mm	17,78mm	19,05mm	20,63mm	22,22mm	23,81mm	25,40mm	26,98mm	28,57mm	31,75mm	34,92mm	38,10mm	41,27mm	44,45mm	46,83mm	50,80mm



PEÇA	DESCRIÇÃO	MARCA	VEÍCULO		ANOS	SOMENTE PARA
C-1630	REPARO DO CIL. AUXILIAR DE EMBREAGEM 22,22mm	FORD - CAMINHÕES	B-1618/1621		1993/1996	
C-1630	REPARO DO CIL. AUXILIAR DE EMBREAGEM 22,22mm	FORD - CAMINHÕES	CARGO		1985/...	
C-1630	REPARO DO CIL. AUXILIAR DE EMBREAGEM 22,22mm	FORD - CAMINHÕES	F-4000		1995/1998	MOTOR MWM 4.3 TURBO
C-1630	REPARO DO CIL. AUXILIAR DE EMBREAGEM 22,22mm	FORD - CAMINHÕES	F-12000		1996/1998	
C-1630	REPARO DO CIL. AUXILIAR DE EMBREAGEM 22,22mm	FORD - CAMINHÕES	F-14000		1996/1998	
C-1630	REPARO DO CIL. AUXILIAR DE EMBREAGEM 22,22mm	VOLKSWAGEN - CAMINHÕES	7-100		1994/2001	
C-1630	REPARO DO CIL. AUXILIAR DE EMBREAGEM 22,22mm	VOLKSWAGEN - CAMINHÕES	7-110		2002/2005	
C-1630	REPARO DO CIL. AUXILIAR DE EMBREAGEM 22,22mm	VOLKSWAGEN - CAMINHÕES	8-100		1997/2000	
C-1630	REPARO DO CIL. AUXILIAR DE EMBREAGEM 22,22mm	VOLKSWAGEN - CAMINHÕES	8-120		2000/...	
C-1630	REPARO DO CIL. AUXILIAR DE EMBREAGEM 22,22mm	VOLKSWAGEN - CAMINHÕES	8-140 CE/CO		1994/2000	
C-1630	REPARO DO CIL. AUXILIAR DE EMBREAGEM 22,22mm	VOLKSWAGEN - CAMINHÕES	8-150		2000/...	
C-1630	REPARO DO CIL. AUXILIAR DE EMBREAGEM 22,22mm	VOLKSWAGEN - CAMINHÕES	9-150 OD		2001/...	
C-1630	REPARO DO CIL. AUXILIAR DE EMBREAGEM 22,22mm	VOLKSWAGEN - CAMINHÕES	12-140H		1994/1998	
C-1630	REPARO DO CIL. AUXILIAR DE EMBREAGEM 22,22mm	VOLKSWAGEN - CAMINHÕES	14-150		1991/2000	
C-1630	REPARO DO CIL. AUXILIAR DE EMBREAGEM 22,22mm	VOLKSWAGEN - CAMINHÕES	14-200		1991/1994	
C-1630	REPARO DO CIL. AUXILIAR DE EMBREAGEM 22,22mm	VOLKSWAGEN - CAMINHÕES	14-220		1992/2000	
C-1630	REPARO DO CIL. AUXILIAR DE EMBREAGEM 22,22mm	VOLKSWAGEN - CAMINHÕES	16-170		1991/1999	
C-1630	REPARO DO CIL. AUXILIAR DE EMBREAGEM 22,22mm	VOLKSWAGEN - CAMINHÕES	16-220		1991/2000	
C-1630	REPARO DO CIL. AUXILIAR DE EMBREAGEM 22,22mm	VOLKSWAGEN - CAMINHÕES	24-220		1991/...	
C-1630	REPARO DO CIL. AUXILIAR DE EMBREAGEM 22,22mm	VOLKSWAGEN - CAMINHÕES	24-250		1992/...	
C-1630	REPARO DO CIL. AUXILIAR DE EMBREAGEM 22,22mm	VOLKSWAGEN - CAMINHÕES	35-300		1991/1999	
C-1630	REPARO DO CIL. AUXILIAR DE EMBREAGEM 22,22mm	VOLKSWAGEN - CAMINHÕES	40-300		1999/2001	
C-1631	REPARO DO CIL. MESTRE DE EMBREAGEM 22,22mm	AGRALE	4500/5000		1994/1998	
C-1631	REPARO DO CIL. MESTRE DE EMBREAGEM 22,22mm	AGRALE	6000		1999/...	
C-1631	REPARO DO CIL. MESTRE DE EMBREAGEM 22,22mm	AGRALE	7000/7500		1993/2005	
C-1631	REPARO DO CIL. MESTRE DE EMBREAGEM 22,22mm	AGRALE	8500		1997/...	
C-1631	REPARO DO CIL. MESTRE DE EMBREAGEM 22,22mm	AGRALE	9200 TCA		2003/...	
C-1631	REPARO DO CIL. MESTRE DE EMBREAGEM 22,22mm	AGRALE	FURGOVAN		2002/...	
C-1631	REPARO DO CIL. MESTRE DE EMBREAGEM 22,22mm	AGRALE	MA 5.0/6.0/7.5/8.0/8.5/9.2		1996/...	
C-1631	REPARO DO CIL. MESTRE DE EMBREAGEM 22,22mm	AGRALE	VOLARE A5/V5		2002/2004	
C-1631	REPARO DO CIL. MESTRE DE EMBREAGEM 22,22mm	AGRALE	VOLARE A6/V6		1998/2004	
C-1631	REPARO DO CIL. MESTRE DE EMBREAGEM 22,22mm	AGRALE	VOLARE W8		2002/2004	
C-1631	REPARO DO CIL. MESTRE DE EMBREAGEM 22,22mm	AGRALE	VOLARE W9		2006/2007	
C-1631	REPARO DO CIL. MESTRE DE EMBREAGEM 22,22mm	FORD - CAMINHÕES	B-1618/1621		1993/1996	
C-1631	REPARO DO CIL. MESTRE DE EMBREAGEM 22,22mm	FORD - CAMINHÕES	F-12000		1996/1998	
C-1631	REPARO DO CIL. MESTRE DE EMBREAGEM 22,22mm	FORD - CAMINHÕES	F-14000		1996/1998	
C-1631	REPARO DO CIL. MESTRE DE EMBREAGEM 22,22mm	VOLKSWAGEN - CAMINHÕES	7-100		1994/2001	
C-1631	REPARO DO CIL. MESTRE DE EMBREAGEM 22,22mm	VOLKSWAGEN - CAMINHÕES	8-100		1997/2000	
C-1631	REPARO DO CIL. MESTRE DE EMBREAGEM 22,22mm	VOLKSWAGEN - CAMINHÕES	8-120		2000/...	
C-1631	REPARO DO CIL. MESTRE DE EMBREAGEM 22,22mm	VOLKSWAGEN - CAMINHÕES	8-140 CE/CO		1994/2000	
C-1631	REPARO DO CIL. MESTRE DE EMBREAGEM 22,22mm	VOLKSWAGEN - CAMINHÕES	8-150		2000/...	
C-1631	REPARO DO CIL. MESTRE DE EMBREAGEM 22,22mm	VOLKSWAGEN - CAMINHÕES	9-150 OD		2001/...	
C-1631	REPARO DO CIL. MESTRE DE EMBREAGEM 22,22mm	VOLKSWAGEN - CAMINHÕES	12-140H		1989/1998	
C-1631	REPARO DO CIL. MESTRE DE EMBREAGEM 22,22mm	VOLKSWAGEN - CAMINHÕES	13-150		2000/...	
C-1631	REPARO DO CIL. MESTRE DE EMBREAGEM 22,22mm	VOLKSWAGEN - CAMINHÕES	13-170		2000/...	
C-1631	REPARO DO CIL. MESTRE DE EMBREAGEM 22,22mm	VOLKSWAGEN - CAMINHÕES	13-180		2000/...	
C-1631	REPARO DO CIL. MESTRE DE EMBREAGEM 22,22mm	VOLKSWAGEN - CAMINHÕES	14-150		1991/2000	
C-1631	REPARO DO CIL. MESTRE DE EMBREAGEM 22,22mm	VOLKSWAGEN - CAMINHÕES	14-200		1991/1994	
C-1631	REPARO DO CIL. MESTRE DE EMBREAGEM 22,22mm	VOLKSWAGEN - CAMINHÕES	14-210		1987/1991	
C-1631	REPARO DO CIL. MESTRE DE EMBREAGEM 22,22mm	VOLKSWAGEN - CAMINHÕES	14-220		1992/2000	
C-1631	REPARO DO CIL. MESTRE DE EMBREAGEM 22,22mm	VOLKSWAGEN - CAMINHÕES	15-170		2000/2006	
C-1631	REPARO DO CIL. MESTRE DE EMBREAGEM 22,22mm	VOLKSWAGEN - CAMINHÕES	15-180		2000/...	
C-1631	REPARO DO CIL. MESTRE DE EMBREAGEM 22,22mm	VOLKSWAGEN - CAMINHÕES	16-170		1991/1999	
C-1631	REPARO DO CIL. MESTRE DE EMBREAGEM 22,22mm	VOLKSWAGEN - CAMINHÕES	16-210		1989/1991	
C-1631	REPARO DO CIL. MESTRE DE EMBREAGEM 22,22mm	VOLKSWAGEN - CAMINHÕES	16-220		1991/2000	
C-1631	REPARO DO CIL. MESTRE DE EMBREAGEM 22,22mm	VOLKSWAGEN - CAMINHÕES	17-210		2000/2006	
C-1631	REPARO DO CIL. MESTRE DE EMBREAGEM 22,22mm	VOLKSWAGEN - CAMINHÕES	17-220		2000/...	
C-1631	REPARO DO CIL. MESTRE DE EMBREAGEM 22,22mm	VOLKSWAGEN - CAMINHÕES	17-300		2000/2002	
C-1631	REPARO DO CIL. MESTRE DE EMBREAGEM 22,22mm	VOLKSWAGEN - CAMINHÕES	17-310		2002/2006	
C-1631	REPARO DO CIL. MESTRE DE EMBREAGEM 22,22mm	VOLKSWAGEN - CAMINHÕES	17-330		2000/2000	
C-1631	REPARO DO CIL. MESTRE DE EMBREAGEM 22,22mm	VOLKSWAGEN - CAMINHÕES	24-220		1991/...	
C-1631	REPARO DO CIL. MESTRE DE EMBREAGEM 22,22mm	VOLKSWAGEN - CAMINHÕES	24-250		1992/...	

Tabela de Conversão	Polegadas	9/16"	5/8"	11/16"	7/10"	3/4"	13/16"	7/8"	15/16"	1"	1 1/16"	1 1/8"	1 1/4"	1 3/8"	1 1/2"	1 5/8"	1 3/4"	1 27/32"	2"
	Milímetros	14,28mm	15,87mm	17,46mm	17,78mm	19,05mm	20,63mm	22,22mm	23,81mm	25,40mm	26,98mm	28,57mm	31,75mm	34,92mm	38,10mm	41,27mm	44,45mm	46,83mm	50,80mm

PEÇA	DESCRIÇÃO	MARCA	VEÍCULO		ANOS	SOMENTE PARA
C-1631	REPARO DO CIL. MESTRE DE EMBREAGEM 22,22mm	VOLKSWAGEN - CAMINHÕES	26-300		2000/2001	
C-1631	REPARO DO CIL. MESTRE DE EMBREAGEM 22,22mm	VOLKSWAGEN - CAMINHÕES	26-310		2002/2005	
C-1631	REPARO DO CIL. MESTRE DE EMBREAGEM 22,22mm	VOLKSWAGEN - CAMINHÕES	35-300		1991/1999	
C-1631	REPARO DO CIL. MESTRE DE EMBREAGEM 22,22mm	VOLKSWAGEN - CAMINHÕES	40-300		1999/2001	
C-1632	REPARO DO CIL. AUXILIAR DE EMBREAGEM 22,22mm	VOLKSWAGEN - CAMINHÕES	13-210		1987/1991	
C-1632	REPARO DO CIL. AUXILIAR DE EMBREAGEM 22,22mm	VOLKSWAGEN - CAMINHÕES	14-210		1987/1991	
C-1632	REPARO DO CIL. AUXILIAR DE EMBREAGEM 22,22mm	VOLKSWAGEN - CAMINHÕES	16-210		1989/1991	
C-1634	REPARO DO CIL. MESTRE DE EMBREAGEM 25,40mm	SCANIA - CAMINHÕES	F/K/S-112		1983/1990	
C-1634	REPARO DO CIL. MESTRE DE EMBREAGEM 25,40mm	SCANIA - CAMINHÕES	R/T-112		1981/1991	
C-1634	REPARO DO CIL. MESTRE DE EMBREAGEM 25,40mm	SCANIA - CAMINHÕES	R/T-142		1981/1991	
C-1635	REPARO DO CIL. MESTRE DE EMBREAGEM 26,00mm	SCANIA - CAMINHÕES	R/T-113		1991/1998	
C-1635	REPARO DO CIL. MESTRE DE EMBREAGEM 26,00mm	SCANIA - CAMINHÕES	R/T-143		1991/1995	
C-1636	REPARO DO CIL. MESTRE DE EMBREAGEM 22,22mm	FORD	F-1000		1996/1998	MOTOR MWM 4.3 DIESEL
C-1636	REPARO DO CIL. MESTRE DE EMBREAGEM 22,22mm	FORD - CAMINHÕES	F-4000		1995/1998	MOTOR MWM 4.3 TURBO
C-1637	REPARO DO CIL. MESTRE DE EMBREAGEM 19,05mm	FORD	F-1000		1995/1998	MOTOR 4.9 GASOLINA/2.5 HSD DIESEL
C-1638	REPARO DO CIL. MESTRE DE EMBREAGEM 28,57mm	VOLVO - CAMINHÕES	B-10 M		1986/...	
C-1638	REPARO DO CIL. MESTRE DE EMBREAGEM 28,57mm	VOLVO - CAMINHÕES	B-12		1992/...	
C-1638	REPARO DO CIL. MESTRE DE EMBREAGEM 28,57mm	VOLVO - CAMINHÕES	B-58		1979/...	
C-1638	REPARO DO CIL. MESTRE DE EMBREAGEM 28,57mm	VOLVO - CAMINHÕES	FH-12		1993/2006	
C-1638	REPARO DO CIL. MESTRE DE EMBREAGEM 28,57mm	VOLVO - CAMINHÕES	N/NL-10		1980/...	
C-1638	REPARO DO CIL. MESTRE DE EMBREAGEM 28,57mm	VOLVO - CAMINHÕES	N/NL-12		1981/...	
C-1638	REPARO DO CIL. MESTRE DE EMBREAGEM 28,57mm	VOLVO - CAMINHÕES	NH-12		1999/2006	
C-1639	REPARO DO CIL. MESTRE DE EMBREAGEM 23,81mm	AGRALE	FURGOVAN		2004/...	MOTOR ELETRÔNICO
C-1639	REPARO DO CIL. MESTRE DE EMBREAGEM 23,81mm	AGRALE	MA 5.0/6.0/7.5/8.0/8.5/9.2		2004/...	MOTOR ELETRÔNICO
C-1639	REPARO DO CIL. MESTRE DE EMBREAGEM 23,81mm	AGRALE	MARRUÁ		2005/...	
C-1639	REPARO DO CIL. MESTRE DE EMBREAGEM 23,81mm	AGRALE	VOLARE A5/V5		2005/2007	
C-1639	REPARO DO CIL. MESTRE DE EMBREAGEM 23,81mm	AGRALE	VOLARE A6/V6		2005/2007	
C-1639	REPARO DO CIL. MESTRE DE EMBREAGEM 23,81mm	AGRALE	VOLARE A8/V8		2000/2007	
C-1639	REPARO DO CIL. MESTRE DE EMBREAGEM 23,81mm	AGRALE	VOLARE W8		2005/2007	
C-1640	REPARO DO CIL. AUXILIAR DE EMBREAGEM 22,22mm	MERCEDES BENZ	SPRINTER		1997/2002	MOD. 310/312/412
C-1641	REPARO DO CIL. AUXILIAR DE EMBREAGEM 25,40mm	MERCEDES BENZ	MB-180		1994/1996	
C-1642	REPARO DO CIL. MESTRE DE EMBREAGEM 15,87mm	ASIA	TOPIC		1993/1999	
C-1642	REPARO DO CIL. MESTRE DE EMBREAGEM 15,87mm	KIA	BESTA		1993/2005	
C-1642	REPARO DO CIL. MESTRE DE EMBREAGEM 15,87mm	KIA	BONGO		1993/2004	K-2400/2700
C-1643	REPARO DO CIL. AUXILIAR DE EMBREAGEM 19,05mm	KIA	BESTA		1993/2005	
C-1643	REPARO DO CIL. AUXILIAR DE EMBREAGEM 19,05mm	KIA	BONGO		1993/2004	K-2400/2700
C-1644	REPARO DO CIL. AUXILIAR DE EMBREAGEM 19,05mm	ASIA	TOPIC		1993/1999	
C-1645	REPARO DO CIL. MESTRE DE EMBREAGEM 20,63mm	MERCEDES BENZ - CAMINHÕES	ACCELO 915 C		2004/...	
C-1645	REPARO DO CIL. MESTRE DE EMBREAGEM 20,63mm	MERCEDES BENZ - CAMINHÕES	L-1215		2000/...	
C-1645	REPARO DO CIL. MESTRE DE EMBREAGEM 20,63mm	MERCEDES BENZ - CAMINHÕES	OF-1721		2000/...	
C-1645	REPARO DO CIL. MESTRE DE EMBREAGEM 20,63mm	MERCEDES BENZ - CAMINHÕES	C-2423 B/K		2000/...	
C-1750	VÁLVULA DE RETENÇÃO DE VÁCUO BRANCA	ALFA ROMEO	2300		1981/1986	P/ SERVO VARGA FD180/SM200
C-1750	VÁLVULA DE RETENÇÃO DE VÁCUO BRANCA	CHRYSLER	DODGE CHARGER		1970/1981	
C-1750	VÁLVULA DE RETENÇÃO DE VÁCUO BRANCA	CHRYSLER	DODGE DART		1970/1981	
C-1750	VÁLVULA DE RETENÇÃO DE VÁCUO BRANCA	CHRYSLER	DODGE LE BARON		1980/1981	
C-1750	VÁLVULA DE RETENÇÃO DE VÁCUO BRANCA	CHRYSLER	DODGE MAGNUM		1980/1981	
C-1750	VÁLVULA DE RETENÇÃO DE VÁCUO BRANCA	CHRYSLER	POLARA		1977/1981	P/ SERVO FD150
C-1750	VÁLVULA DE RETENÇÃO DE VÁCUO BRANCA	FIAT	147/SPAZIO		1983/1987	P/ SERVO VARGA SM180
C-1750	VÁLVULA DE RETENÇÃO DE VÁCUO BRANCA	FIAT	FIORINO (mod. 147)		1983/1988	P/ SERVO VARGA FD180
C-1750	VÁLVULA DE RETENÇÃO DE VÁCUO BRANCA	FIAT	OGGI		1983/1985	P/ SERVO VARGA FD180
C-1750	VÁLVULA DE RETENÇÃO DE VÁCUO BRANCA	FIAT	PANORAMA		1983/1987	P/ SERVO VARGA FD180
C-1750	VÁLVULA DE RETENÇÃO DE VÁCUO BRANCA	FORD	BELINA II		1978/1991	P/ SERVO VARGA FD30/FD150/SM180
C-1750	VÁLVULA DE RETENÇÃO DE VÁCUO BRANCA	FORD	CORCEL II		1978/1986	P/ SERVO VARGA FD30/FD150/SM180
C-1750	VÁLVULA DE RETENÇÃO DE VÁCUO BRANCA	FORD	DEL REY		1981/1991	P/ SERVO VARGA SM180
C-1750	VÁLVULA DE RETENÇÃO DE VÁCUO BRANCA	FORD	GALAXIE		1977/1982	
C-1750	VÁLVULA DE RETENÇÃO DE VÁCUO BRANCA	FORD	PAMPA		1982/1997	P/ SERVO VARGA SM180
C-1750	VÁLVULA DE RETENÇÃO DE VÁCUO BRANCA	GM - CHEVROLET	CARAVAN		1975/1982	P/ SERVO VARGA FD150/SM180
C-1750	VÁLVULA DE RETENÇÃO DE VÁCUO BRANCA	GM - CHEVROLET	OPALA		1971/1990	P/ SERVO VARGA FD150/SM180
C-1750	VÁLVULA DE RETENÇÃO DE VÁCUO BRANCA	PUMA	GTB		1974/1980	P/ SERVO FD150
C-1750	VÁLVULA DE RETENÇÃO DE VÁCUO BRANCA	TOYOTA	BANDEIRANTE		1982/1986	P/ SERVO VARGA FD180/SM180
C-1750	VÁLVULA DE RETENÇÃO DE VÁCUO BRANCA	VOLKSWAGEN	GOL (G1)		1981/1996	P/ SERVO VARGA SM180/SM200
C-1750	VÁLVULA DE RETENÇÃO DE VÁCUO BRANCA	VOLKSWAGEN	PARATI (G1)		1983/1996	P/ SERVO VARGA SM180/SM200

Polgadas	9/16"	5/8"	11/16"	7/10"	3/4"	13/16"	7/8"	15/16"	1"	1 1/16"	1 1/8"	1 1/4"	1 3/8"	1 1/2"	1 5/8"	1 3/4"	1 27/32"	2"
Milímetros	14,28mm	15,87mm	17,46mm	17,78mm	19,05mm	20,63mm	22,22mm	23,81mm	25,40mm	26,98mm	28,57mm	31,75mm	34,92mm	38,10mm	41,27mm	44,45mm	46,83mm	50,80mm

PEÇA	DESCRIÇÃO	MARCA	VEÍCULO		ANOS	SOMENTE PARA
C-1750	VÁLVULA DE RETENÇÃO DE VÁCUO BRANCA	VOLKSWAGEN	PASSAT		1977/1989	P/ SERVO VARGA FD180/SM180
C-1750	VÁLVULA DE RETENÇÃO DE VÁCUO BRANCA	VOLKSWAGEN	QUANTUM		1985/2002	P/ SERVO VARGA
C-1750	VÁLVULA DE RETENÇÃO DE VÁCUO BRANCA	VOLKSWAGEN	SANTANA		1984/2006	P/ SERVO VARGA
C-1750	VÁLVULA DE RETENÇÃO DE VÁCUO BRANCA	VOLKSWAGEN	SAVEIRO (G1)		1982/1997	P/ SERVO VARGA FD180/SM180/SM200
C-1750	VÁLVULA DE RETENÇÃO DE VÁCUO BRANCA	VOLKSWAGEN	VOYAGE (G1)		1982/1996	P/ SERVO VARGA SM180/SM200
C-1753	VÁLVULA DE RETENÇÃO DE VÁCUO	CHRYSLER	POLARA		1977/1981	
C-1753	VÁLVULA DE RETENÇÃO DE VÁCUO	FIAT	147/SPAZIO		1983/1987	SIST. VARGA
C-1753	VÁLVULA DE RETENÇÃO DE VÁCUO	FIAT	COUPÉ		1995/1997	
C-1753	VÁLVULA DE RETENÇÃO DE VÁCUO	FIAT	FIORINO (mod. 147)		1983/1988	SIST. VARGA
C-1753	VÁLVULA DE RETENÇÃO DE VÁCUO	FIAT	OGGI		1983/1985	SIST. VARGA
C-1753	VÁLVULA DE RETENÇÃO DE VÁCUO	FIAT	PANORAMA		1983/1987	SIST. VARGA
C-1753	VÁLVULA DE RETENÇÃO DE VÁCUO	FIAT	TEMPRA SW		1994/1997	
C-1753	VÁLVULA DE RETENÇÃO DE VÁCUO	FIAT	TIPO		1993/1997	
C-1753	VÁLVULA DE RETENÇÃO DE VÁCUO	FORD	BELINA II		1980/1991	
C-1753	VÁLVULA DE RETENÇÃO DE VÁCUO	FORD	CORCEL II		1980/1986	
C-1753	VÁLVULA DE RETENÇÃO DE VÁCUO	FORD	DEL REY		1981/1991	
C-1753	VÁLVULA DE RETENÇÃO DE VÁCUO	FORD	PAMPA		1982/1997	
C-1753	VÁLVULA DE RETENÇÃO DE VÁCUO	FORD	ROYALE		1992/1996	
C-1753	VÁLVULA DE RETENÇÃO DE VÁCUO	FORD	VERSAILLES		1991/1994	
C-1753	VÁLVULA DE RETENÇÃO DE VÁCUO	GM - CHEVROLET	CARAVAN		1975/1992	SIST. VARGA
C-1753	VÁLVULA DE RETENÇÃO DE VÁCUO	GM - CHEVROLET	OPALA		1971/1992	SIST. VARGA
C-1753	VÁLVULA DE RETENÇÃO DE VÁCUO	GURGEL	G-15		1980/1984	
C-1753	VÁLVULA DE RETENÇÃO DE VÁCUO	GURGEL	G-800 CS/CD		1983/1991	
C-1753	VÁLVULA DE RETENÇÃO DE VÁCUO	GURGEL	X-15/CARAJÁS		1985/1993	
C-1753	VÁLVULA DE RETENÇÃO DE VÁCUO	PUMA	GTB		1974/1980	
C-1753	VÁLVULA DE RETENÇÃO DE VÁCUO	TOYOTA	BANDEIRANTE		1983/2001	
C-1753	VÁLVULA DE RETENÇÃO DE VÁCUO	TROLLER	T4		1997/2001	
C-1753	VÁLVULA DE RETENÇÃO DE VÁCUO	VOLKSWAGEN	GOL (G1)		1981/1996	
C-1753	VÁLVULA DE RETENÇÃO DE VÁCUO	VOLKSWAGEN	KOMBI		1976/...	
C-1753	VÁLVULA DE RETENÇÃO DE VÁCUO	VOLKSWAGEN	PARATI (G1)		1983/1996	
C-1753	VÁLVULA DE RETENÇÃO DE VÁCUO	VOLKSWAGEN	PASSAT		1977/1989	
C-1753	VÁLVULA DE RETENÇÃO DE VÁCUO	VOLKSWAGEN	QUANTUM		1985/2002	
C-1753	VÁLVULA DE RETENÇÃO DE VÁCUO	VOLKSWAGEN	SANTANA		1984/2006	
C-1753	VÁLVULA DE RETENÇÃO DE VÁCUO	VOLKSWAGEN	SAVEIRO (G1)		1982/1997	
C-1753	VÁLVULA DE RETENÇÃO DE VÁCUO	VOLKSWAGEN	VOYAGE (G1)		1982/1996	
C-1755	VÁLVULA DE RETENÇÃO DE VÁCUO	AGRALE	1600 A/D RS/RD		1986/1989	
C-1755	VÁLVULA DE RETENÇÃO DE VÁCUO	AGRALE	1800 D RS/RD		1988/1989	
C-1755	VÁLVULA DE RETENÇÃO DE VÁCUO	CHRYSLER	DODGE 1800		1976/1976	
C-1755	VÁLVULA DE RETENÇÃO DE VÁCUO	FIAT	147/SPAZIO		1976/1987	SIST. BENDIX
C-1755	VÁLVULA DE RETENÇÃO DE VÁCUO	FIAT	DUNA		1994/1996	
C-1755	VÁLVULA DE RETENÇÃO DE VÁCUO	FIAT	ELBA		1986/1996	
C-1755	VÁLVULA DE RETENÇÃO DE VÁCUO	FIAT	FIORINO (mod. 147)		1978/1988	SIST. BENDIX
C-1755	VÁLVULA DE RETENÇÃO DE VÁCUO	FIAT	FIORINO (mod. Uno)		1988/...	
C-1755	VÁLVULA DE RETENÇÃO DE VÁCUO	FIAT	OGGI		1983/1985	SIST. BENDIX
C-1755	VÁLVULA DE RETENÇÃO DE VÁCUO	FIAT	PANORAMA		1980/1987	SIST. BENDIX
C-1755	VÁLVULA DE RETENÇÃO DE VÁCUO	FIAT	PRÊMIO		1985/1996	
C-1755	VÁLVULA DE RETENÇÃO DE VÁCUO	FIAT	UNO		1984/...	
C-1755	VÁLVULA DE RETENÇÃO DE VÁCUO	FIAT	UNO TURBO		1994/1996	
C-1755	VÁLVULA DE RETENÇÃO DE VÁCUO	FORD	F-100		1979/1987	
C-1755	VÁLVULA DE RETENÇÃO DE VÁCUO	FORD	F-1000		1979/1992	
C-1755	VÁLVULA DE RETENÇÃO DE VÁCUO	FORD	F-2000		1980/1987	
C-1755	VÁLVULA DE RETENÇÃO DE VÁCUO	FORD	MAVERICK		1977/1979	
C-1755	VÁLVULA DE RETENÇÃO DE VÁCUO	GM - CHEVROLET	A-10		1979/1988	
C-1755	VÁLVULA DE RETENÇÃO DE VÁCUO	GM - CHEVROLET	A-20		1985/1988	
C-1755	VÁLVULA DE RETENÇÃO DE VÁCUO	GM - CHEVROLET	BLAZER		1996/2011	
C-1755	VÁLVULA DE RETENÇÃO DE VÁCUO	GM - CHEVROLET	C-10/14/15/16		1979/1989	
C-1755	VÁLVULA DE RETENÇÃO DE VÁCUO	GM - CHEVROLET	C-20		1985/1988	
C-1755	VÁLVULA DE RETENÇÃO DE VÁCUO	GM - CHEVROLET	CARAVAN		1981/1990	SIST. BOSCH
C-1755	VÁLVULA DE RETENÇÃO DE VÁCUO	GM - CHEVROLET	CHEVETTE		1977/1994	
C-1755	VÁLVULA DE RETENÇÃO DE VÁCUO	GM - CHEVROLET	CHEVY		1983/1995	
C-1755	VÁLVULA DE RETENÇÃO DE VÁCUO	GM - CHEVROLET	D-10		1979/1984	
C-1755	VÁLVULA DE RETENÇÃO DE VÁCUO	GM - CHEVROLET	D-20		1985/1988	

Tabela de Conversão	Polegadas	9/16"	5/8"	11/16"	7/10"	3/4"	13/16"	7/8"	15/16"	1"	1 1/16"	1 1/8"	1 1/4"	1 3/8"	1 1/2"	1 5/8"	1 3/4"	1 27/32"	2"
	Milímetros	14,28mm	15,87mm	17,46mm	17,78mm	19,05mm	20,63mm	22,22mm	23,81mm	25,40mm	26,98mm	28,57mm	31,75mm	34,92mm	38,10mm	41,27mm	44,45mm	46,83mm	50,80mm



PEÇA	DESCRIÇÃO	MARCA	VEÍCULO		ANOS	SOMENTE PARA
C-1755	VÁLVULA DE RETENÇÃO DE VÁCUO	GM - CHEVROLET	IPANEMA		1990/1998	SIST. VARGA E BOSCH
C-1755	VÁLVULA DE RETENÇÃO DE VÁCUO	GM - CHEVROLET	KADETT		1989/1998	SIST. VARGA E BOSCH
C-1755	VÁLVULA DE RETENÇÃO DE VÁCUO	GM - CHEVROLET	MARAJÓ		1981/1989	
C-1755	VÁLVULA DE RETENÇÃO DE VÁCUO	GM - CHEVROLET	MONZA		1981/1996	SIST. VARGA E BOSCH
C-1755	VÁLVULA DE RETENÇÃO DE VÁCUO	GM - CHEVROLET	OPALA		1981/1990	SIST. BOSCH
C-1755	VÁLVULA DE RETENÇÃO DE VÁCUO	GM - CHEVROLET	S-10		1995/2012	
C-1755	VÁLVULA DE RETENÇÃO DE VÁCUO	GM - CHEVROLET	VERANEIO		1979/1988	
C-1755	VÁLVULA DE RETENÇÃO DE VÁCUO	RENAULT	19		1992/1998	
C-1755	VÁLVULA DE RETENÇÃO DE VÁCUO	RENAULT	CLIO		1996/1999	
C-1755	VÁLVULA DE RETENÇÃO DE VÁCUO	TROLLER	T4		2002/...	
C-1937	REPARO DO PISTÃO DA PINÇA 66,00mm					

Tabela de Conversão	Polegadas	9/16"	5/8"	11/16"	7/10"	3/4"	13/16"	7/8"	15/16"	1"	1 1/16"	1 1/8"	1 1/4"	1 3/8"	1 1/2"	1 5/8"	1 3/4"	1 27/32"	2"
	Milímetros		14,28mm	15,87mm	17,46mm	17,78mm	19,05mm	20,63mm	22,22mm	23,81mm	25,40mm	26,98mm	28,57mm	31,75mm	34,92mm	38,10mm	41,27mm	44,45mm	46,83mm



---

## CILINDRO MESTRE

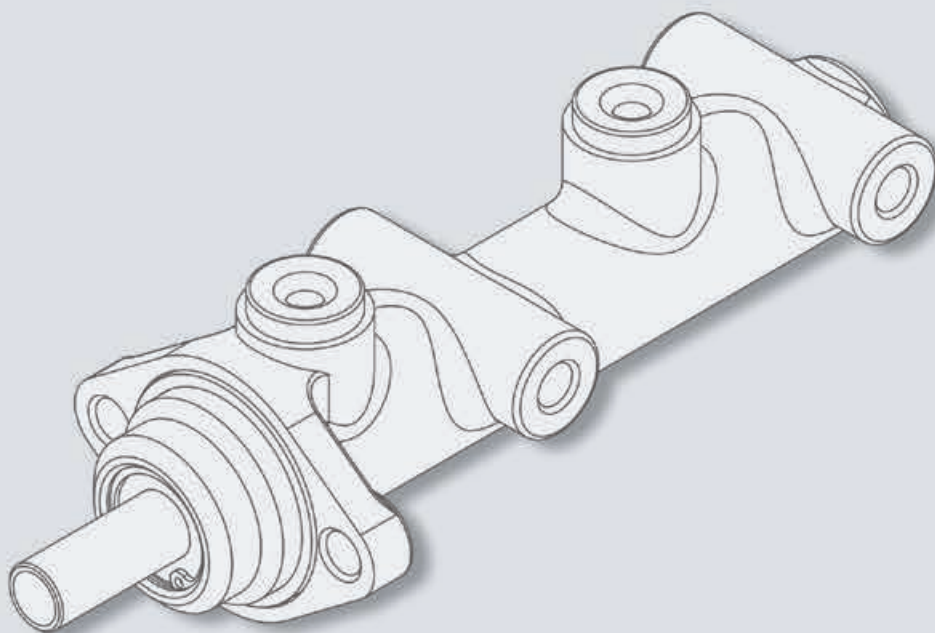

PEÇA	DESCRIÇÃO	MARCA	VEÍCULO		ANOS	SOMENTE PARA
C-2000	CILINDRO MESTRE DUPLO 20,63mm	VOLKSWAGEN	GOL (G1)		1985/1996	
C-2000	CILINDRO MESTRE DUPLO 20,63mm	VOLKSWAGEN	GOL (G2)		1995/2001	MOTOR 1.0/1.6/1.8 S/ABS
C-2000	CILINDRO MESTRE DUPLO 20,63mm	VOLKSWAGEN	GOL (G2)		2002/2005	MOTOR 1.0
C-2000	CILINDRO MESTRE DUPLO 20,63mm	VOLKSWAGEN	GOL (G3)		2000/2000	MOTOR 1.0/1.6/1.8 S/ABS
C-2000	CILINDRO MESTRE DUPLO 20,63mm	VOLKSWAGEN	PARATI (G1)		1985/1996	
C-2000	CILINDRO MESTRE DUPLO 20,63mm	VOLKSWAGEN	SAVEIRO (G1)		1985/1997	
C-2000	CILINDRO MESTRE DUPLO 20,63mm	VOLKSWAGEN	VOYAGE (G1)		1985/1996	
C-2001	CILINDRO MESTRE DUPLO 20,63mm	GM - CHEVROLET	CHEVETTE		1973/1980	USE C/ RESERV. C-0100
C-2001	CILINDRO MESTRE DUPLO 20,63mm	GM - CHEVROLET	CHEVETTE		1981/1986	C/SERVO E S/SERVO
C-2001	CILINDRO MESTRE DUPLO 20,63mm	GM - CHEVROLET	CHEVY		1983/1986	C/SERVO E S/SERVO
C-2001	CILINDRO MESTRE DUPLO 20,63mm	GM - CHEVROLET	MARAJÓ		1981/1986	C/SERVO E S/SERVO
C-2002	CILINDRO MESTRE DUPLO 22,22mm	FORD	BELINA II		1978/1991	C/SERVO
C-2002	CILINDRO MESTRE DUPLO 22,22mm	FORD	CORCEL II		1978/1986	C/SERVO
C-2002	CILINDRO MESTRE DUPLO 22,22mm	FORD	DEL REY		1981/1991	
C-2002	CILINDRO MESTRE DUPLO 22,22mm	FORD	PAMPA		1982/1997	
C-2003	CILINDRO MESTRE SIMPLES 17,46mm	GURGEL	X-12/TOCANTINS		1969/1977	
C-2003	CILINDRO MESTRE SIMPLES 17,46mm	PUMA	GT/GTE/GTS		1968/1973	
C-2003	CILINDRO MESTRE SIMPLES 17,46mm	VOLKSWAGEN	FUSCA		1967/1976	C/ <-
C-2003	CILINDRO MESTRE SIMPLES 17,46mm	VOLKSWAGEN	KARMANN GHIA		1967/1969	
C-2005	CILINDRO MESTRE SIMPLES 19,05mm	VOLKSWAGEN	BRASILIA		1973/1976	
C-2005	CILINDRO MESTRE SIMPLES 19,05mm	VOLKSWAGEN	FUSCA		1970/1976	C/ <-
C-2005	CILINDRO MESTRE SIMPLES 19,05mm	VOLKSWAGEN	SEDAN 1600 4 PORTAS		1969/1971	
C-2005	CILINDRO MESTRE SIMPLES 19,05mm	VOLKSWAGEN	TL		1969/1976	
C-2005	CILINDRO MESTRE SIMPLES 19,05mm	VOLKSWAGEN	VARIANT		1970/1976	
C-2006	CILINDRO MESTRE DUPLO 19,05mm	FIAT	147/SPAZIO		1976/1987	SIST. ATE C/ E S/SERVO
C-2006	CILINDRO MESTRE DUPLO 19,05mm	FIAT	FIORINO (mod. 147)		1978/1988	SIST. ATE
C-2006	CILINDRO MESTRE DUPLO 19,05mm	FIAT	OGGI		1983/1985	SIST. ATE
C-2006	CILINDRO MESTRE DUPLO 19,05mm	FIAT	PANORAMA		1980/1987	SIST. ATE
C-2007	CILINDRO MESTRE DUPLO 19,05mm	GURGEL	X-12/TOCANTINS		1978/1993	
C-2007	CILINDRO MESTRE DUPLO 19,05mm	GURGEL	XEF		1984/1986	
C-2007	CILINDRO MESTRE DUPLO 19,05mm	VOLKSWAGEN	BRASILIA		1977/1982	
C-2007	CILINDRO MESTRE DUPLO 19,05mm	VOLKSWAGEN	FUSCA		1977/1996	
C-2007	CILINDRO MESTRE DUPLO 19,05mm	VOLKSWAGEN	VARIANT		1977/1977	
C-2008	CILINDRO MESTRE DUPLO 22,00mm	FORD	ESCORT		1983/1992	SIST. BENDIX
C-2008	CILINDRO MESTRE DUPLO 22,00mm	FORD	ESCORT HOBBY		1993/1996	
C-2008	CILINDRO MESTRE DUPLO 22,00mm	FORD	VERONA		1990/1992	
C-2008	CILINDRO MESTRE DUPLO 22,00mm	VOLKSWAGEN	APOLLO		1990/1992	
C-2009	CILINDRO MESTRE DUPLO 20,63mm	VOLKSWAGEN	GOL (G1)		1981/1984	C/SERVO
C-2009	CILINDRO MESTRE DUPLO 20,63mm	VOLKSWAGEN	PARATI (G1)		1983/1984	
C-2009	CILINDRO MESTRE DUPLO 20,63mm	VOLKSWAGEN	PASSAT		1977/1984	C/SERVO
C-2009	CILINDRO MESTRE DUPLO 20,63mm	VOLKSWAGEN	SANTANA		1984/1990	SIST. VARGA E BOSCH S/ABS
C-2009	CILINDRO MESTRE DUPLO 20,63mm	VOLKSWAGEN	SAVEIRO (G1)		1982/1984	
C-2009	CILINDRO MESTRE DUPLO 20,63mm	VOLKSWAGEN	VOYAGE (G1)		1982/1984	
C-2010	CILINDRO MESTRE DUPLO 22,22mm	GM - CHEVROLET	CARAVAN		1979/1980	USE C/ SERVO C-5634
C-2010	CILINDRO MESTRE DUPLO 22,22mm	GM - CHEVROLET	CARAVAN		1981/1992	SIST. VARGA
C-2010	CILINDRO MESTRE DUPLO 22,22mm	GM - CHEVROLET	OPALA		1979/1980	USE C/ SERVO C-5634
C-2010	CILINDRO MESTRE DUPLO 22,22mm	GM - CHEVROLET	OPALA		1981/1992	SIST. VARGA
C-2012	CILINDRO MESTRE DUPLO 20,63mm	GM - CHEVROLET	MONZA		1981/1987	
C-2013	CILINDRO MESTRE DUPLO 23,81mm	TOYOTA	BANDEIRANTE		1995/2001	C/ <-
C-2014	CILINDRO MESTRE DUPLO 22,22mm	GM - CHEVROLET	IPANEMA		1990/1998	SIST. VARGA
C-2014	CILINDRO MESTRE DUPLO 22,22mm	GM - CHEVROLET	KADETT		1989/1998	SIST. VARGA
C-2014	CILINDRO MESTRE DUPLO 22,22mm	GM - CHEVROLET	MONZA		1988/1996	SIST. VARGA S/ABS
C-2015	CILINDRO MESTRE DUPLO 20,63mm	FORD	VERSAILLES		1991/1994	SIST. VARGA E BOSCH S/ABS
C-2015	CILINDRO MESTRE DUPLO 20,63mm	VOLKSWAGEN	PASSAT		1985/1989	
C-2015	CILINDRO MESTRE DUPLO 20,63mm	VOLKSWAGEN	SANTANA		1991/1994	SIST. VARGA E BOSCH S/ABS
C-2015	CILINDRO MESTRE DUPLO 20,63mm	VOLKSWAGEN	SAVEIRO (G1)		1984/1985	
C-2016	CILINDRO MESTRE DUPLO 22,22mm	GM - CHEVROLET	CARAVAN		1981/1990	SIST. BOSCH
C-2016	CILINDRO MESTRE DUPLO 22,22mm	GM - CHEVROLET	OPALA		1981/1990	SIST. BOSCH
C-2017	CILINDRO MESTRE SIMPLES 23,81mm	GURGEL	G-15		1980/1981	
C-2017	CILINDRO MESTRE SIMPLES 23,81mm	GURGEL	G-800 CS/CD		1983/1983	
C-2017	CILINDRO MESTRE SIMPLES 23,81mm	VOLKSWAGEN	KOMBI		1976/1982	
C-2018	CILINDRO MESTRE DUPLO 23,81mm	GURGEL	G-15		1982/1984	

Tabela de Conversão	Polegadas	9/16"	5/8"	11/16"	7/10"	3/4"	13/16"	7/8"	15/16"	1"	1 1/16"	1 1/8"	1 1/4"	1 3/8"	1 1/2"	1 5/8"	1 3/4"	1 27/32"	2"
	Milímetros		14,28mm	15,87mm	17,46mm	17,78mm	19,05mm	20,63mm	22,22mm	23,81mm	25,40mm	26,98mm	28,57mm	31,75mm	34,92mm	38,10mm	41,27mm	44,45mm	46,83mm

PEÇA	DESCRIÇÃO	MARCA	VEÍCULO		ANOS	SOMENTE PARA
C-2018	CILINDRO MESTRE DUPLO 23,81mm	GURGEL	G-800 CS/CD		1983/1991	
C-2018	CILINDRO MESTRE DUPLO 23,81mm	GURGEL	X-15/CARAJÁS		1985/1993	
C-2018	CILINDRO MESTRE DUPLO 23,81mm	VOLKSWAGEN	KOMBI		1982/...	
C-2030	CILINDRO MESTRE DUPLO 19,05mm	FIAT	ELBA		1986/1991	
C-2030	CILINDRO MESTRE DUPLO 19,05mm	FIAT	FIORINO (mod. Uno)		1988/1991	
C-2030	CILINDRO MESTRE DUPLO 19,05mm	FIAT	PRÊMIO		1985/1991	
C-2030	CILINDRO MESTRE DUPLO 19,05mm	FIAT	UNO		1984/1991	
C-2030	CILINDRO MESTRE DUPLO 19,05mm	GURGEL	BR-800/SUPERMINI		1989/1993	
C-2032	CILINDRO MESTRE DUPLO 20,63mm	GM - CHEVROLET	CHEVETTE		1987/1994	SIST. ATE
C-2032	CILINDRO MESTRE DUPLO 20,63mm	GM - CHEVROLET	CHEVY		1987/1995	SIST. ATE
C-2032	CILINDRO MESTRE DUPLO 20,63mm	GM - CHEVROLET	MARAJÓ		1987/1989	SIST. ATE
C-2033	CILINDRO MESTRE DUPLO 20,63mm	FIAT	DUNA		1994/1996	SIST. ATE
C-2033	CILINDRO MESTRE DUPLO 20,63mm	FIAT	ELBA		1991/1996	SIST. ATE
C-2033	CILINDRO MESTRE DUPLO 20,63mm	FIAT	FIORINO (mod. Uno)		1991/1993	SIST. ATE
C-2033	CILINDRO MESTRE DUPLO 20,63mm	FIAT	PRÊMIO		1991/1996	SIST. ATE
C-2033	CILINDRO MESTRE DUPLO 20,63mm	FIAT	UNO		1987/1991	MOD. 1.5R/1.6R
C-2033	CILINDRO MESTRE DUPLO 20,63mm	FIAT	UNO		1991/2010	SIST. ATE
C-2033	CILINDRO MESTRE DUPLO 20,63mm	FIAT	UNO		2011/...	MILLE/FURGÃO
C-2034	CILINDRO MESTRE DUPLO 20,63mm	GM - CHEVROLET	CHEVETTE		1987/1994	SIST. BOSCH
C-2034	CILINDRO MESTRE DUPLO 20,63mm	GM - CHEVROLET	CHEVY		1987/1995	SIST. BOSCH
C-2034	CILINDRO MESTRE DUPLO 20,63mm	GM - CHEVROLET	MARAJÓ		1987/1989	SIST. BOSCH
C-2035	CILINDRO MESTRE DUPLO 20,63mm	FIAT	DUNA		1994/1996	SIST. BOSCH
C-2035	CILINDRO MESTRE DUPLO 20,63mm	FIAT	ELBA		1991/1996	SIST. BOSCH
C-2035	CILINDRO MESTRE DUPLO 20,63mm	FIAT	FIORINO (mod. Uno)		1991/1993	SIST. BOSCH
C-2035	CILINDRO MESTRE DUPLO 20,63mm	FIAT	PRÊMIO		1991/1996	SIST. BOSCH
C-2035	CILINDRO MESTRE DUPLO 20,63mm	FIAT	UNO		1991/2010	SIST. BOSCH
C-2036	CILINDRO MESTRE SIMPLES 25,40mm	FORD	AERO/ITAMARATY		1961/1971	
C-2036	CILINDRO MESTRE SIMPLES 25,40mm	FORD	F-75		1960/1982	
C-2036	CILINDRO MESTRE SIMPLES 25,40mm	FORD	JEEP		1960/1981	
C-2036	CILINDRO MESTRE SIMPLES 25,40mm	FORD	RURAL		1960/1977	
C-2038	CILINDRO MESTRE DUPLO 23,81mm	FORD	ESCORT		1993/1996	SIST. VARGA
C-2038	CILINDRO MESTRE DUPLO 23,81mm	FORD	VERONA		1994/1996	SIST. VARGA
C-2038	CILINDRO MESTRE DUPLO 23,81mm	VOLKSWAGEN	LOGUS		1993/1996	SIST. VARGA
C-2038	CILINDRO MESTRE DUPLO 23,81mm	VOLKSWAGEN	POINTER		1994/1996	SIST. VARGA
C-2039	CILINDRO MESTRE DUPLO 25,40mm	FORD	F-100		1982/1984	USE C/ RESERV. C-0105
C-2039	CILINDRO MESTRE DUPLO 25,40mm	FORD	F-100		1985/1987	
C-2039	CILINDRO MESTRE DUPLO 25,40mm	FORD	F-1000		1979/1984	USE C/ RESERV. C-0105
C-2039	CILINDRO MESTRE DUPLO 25,40mm	FORD	F-1000		1985/1992	
C-2039	CILINDRO MESTRE DUPLO 25,40mm	FORD	F-2000		1980/1984	USE C/ RESERV. C-0105
C-2039	CILINDRO MESTRE DUPLO 25,40mm	FORD	F-2000		1985/1987	
C-2041	CILINDRO MESTRE DUPLO 20,63mm	GM - CHEVROLET	CORSA		1994/1998	SIST. ATE
C-2041	CILINDRO MESTRE DUPLO 20,63mm	GM - CHEVROLET	CORSA PICK-UP		1995/1998	SIST. ATE
C-2042	CILINDRO MESTRE DUPLO 22,22mm	FIAT	FIORINO (mod. Uno)		1994/...	SIST. BOSCH
C-2042	CILINDRO MESTRE DUPLO 22,22mm	FIAT	PALIO		1998/...	SIST. BOSCH S/ABS
C-2042	CILINDRO MESTRE DUPLO 22,22mm	FIAT	PALIO WEEKEND		1998/...	SIST. BOSCH S/ABS
C-2042	CILINDRO MESTRE DUPLO 22,22mm	FIAT	SIENA		1998/...	SIST. BOSCH S/ABS
C-2042	CILINDRO MESTRE DUPLO 22,22mm	FIAT	STRADA		1999/...	SIST. BOSCH S/ABS
C-2042	CILINDRO MESTRE DUPLO 22,22mm	FIAT	TEMPRA		1992/1999	MOTOR 2.0 8V/16V S/ABS
C-2044	CILINDRO MESTRE DUPLO 28,57mm	AGRALE	1600 A/D RS/RD		1990/1996	
C-2044	CILINDRO MESTRE DUPLO 28,57mm	AGRALE	1800 D RS/RD		1990/1996	
C-2044	CILINDRO MESTRE DUPLO 28,57mm	AGRALE	VOLARE A5/V5		2002/...	
C-2044	CILINDRO MESTRE DUPLO 28,57mm	AGRALE	VOLARE A6/V6		1998/...	
C-2044	CILINDRO MESTRE DUPLO 28,57mm	GM - CHEVROLET	A-10		1989/1989	
C-2044	CILINDRO MESTRE DUPLO 28,57mm	GM - CHEVROLET	A-20		1989/1992	
C-2044	CILINDRO MESTRE DUPLO 28,57mm	GM - CHEVROLET	BONANZA		1990/1992	
C-2044	CILINDRO MESTRE DUPLO 28,57mm	GM - CHEVROLET	C-10/14/15/16		1989/1989	
C-2044	CILINDRO MESTRE DUPLO 28,57mm	GM - CHEVROLET	C-20		1989/1992	
C-2044	CILINDRO MESTRE DUPLO 28,57mm	GM - CHEVROLET	D-20		1989/1992	
C-2044	CILINDRO MESTRE DUPLO 28,57mm	GM - CHEVROLET	VERANEIO		1989/1992	
C-2045	CILINDRO MESTRE DUPLO 28,57mm	GM - CHEVROLET	A-20		1993/1996	
C-2045	CILINDRO MESTRE DUPLO 28,57mm	GM - CHEVROLET	BONANZA		1993/1996	EXCETO TURBO
C-2045	CILINDRO MESTRE DUPLO 28,57mm	GM - CHEVROLET	C-20		1993/1996	

Tabela de Conversão	Polegadas	9/16"	5/8"	11/16"	7/10"	3/4"	13/16"	7/8"	15/16"	1"	1 1/16"	1 1/8"	1 1/4"	1 3/8"	1 1/2"	1 5/8"	1 3/4"	1 27/32"	2"
	Milímetros	14,28mm	15,87mm	17,46mm	17,78mm	19,05mm	20,63mm	22,22mm	23,81mm	25,40mm	26,98mm	28,57mm	31,75mm	34,92mm	38,10mm	41,27mm	44,45mm	46,83mm	50,80mm

PEÇA	DESCRIÇÃO	MARCA	VEÍCULO		ANOS	SOMENTE PARA
C-2045	CILINDRO MESTRE DUPLO 28,57mm	GM - CHEVROLET	D-20		1993/1996	EXCETO TURBO
C-2045	CILINDRO MESTRE DUPLO 28,57mm	GM - CHEVROLET	VERANEIO		1993/1996	EXCETO TURBO
C-2046	CILINDRO MESTRE DUPLO 20,63mm	FIAT	PALIO		1996/1998	S/ABS
C-2046	CILINDRO MESTRE DUPLO 20,63mm	FIAT	PALIO WEEKEND		1997/1998	MOTOR 1.5 S/ABS
C-2046	CILINDRO MESTRE DUPLO 20,63mm	FIAT	SIENA		1998/1998	S/ABS
C-2051	CILINDRO MESTRE DUPLO 23,81mm	FORD	ESCORT		1993/2003	SIST. BOSCH
C-2051	CILINDRO MESTRE DUPLO 23,81mm	FORD	ESCORT SW		1997/2003	
C-2051	CILINDRO MESTRE DUPLO 23,81mm	FORD	VERONA		1994/1996	SIST. BOSCH
C-2051	CILINDRO MESTRE DUPLO 23,81mm	VOLKSWAGEN	LOGUS		1993/1996	SIST. BOSCH
C-2051	CILINDRO MESTRE DUPLO 23,81mm	VOLKSWAGEN	POINTER		1994/1996	SIST. BOSCH
C-2052	CILINDRO MESTRE DUPLO 25,40mm C/ RESERV.	GM - CHEVROLET	A-10		1979/1984	
C-2052	CILINDRO MESTRE DUPLO 25,40mm C/ RESERV.	GM - CHEVROLET	C-10/14/15/16		1979/1984	
C-2052	CILINDRO MESTRE DUPLO 25,40mm C/ RESERV.	GM - CHEVROLET	D-10		1979/1984	
C-2052	CILINDRO MESTRE DUPLO 25,40mm C/ RESERV.	GM - CHEVROLET	VERANEIO		1979/1988	
C-2053	CILINDRO MESTRE DUPLO 22,22mm	ALFA ROMEO	145		1996/1999	S/ABS
C-2053	CILINDRO MESTRE DUPLO 22,22mm	ALFA ROMEO	155		1995/1998	S/ABS
C-2053	CILINDRO MESTRE DUPLO 22,22mm	ALFA ROMEO	SPIDER		1996/1998	S/ABS
C-2053	CILINDRO MESTRE DUPLO 22,22mm	FIAT	BRAVA		2000/2002	MOTOR 1.6 16V S/ABS
C-2053	CILINDRO MESTRE DUPLO 22,22mm	FIAT	COUPÉ		1995/1997	S/ABS
C-2053	CILINDRO MESTRE DUPLO 22,22mm	FIAT	MAREA		2006/2007	MOTOR 1.6 16V S/ABS
C-2053	CILINDRO MESTRE DUPLO 22,22mm	FIAT	MAREA WEEKEND		2006/2007	MOTOR 1.6 16V S/ABS
C-2053	CILINDRO MESTRE DUPLO 22,22mm	FIAT	TEMPRA SW		1994/1997	S/ABS
C-2053	CILINDRO MESTRE DUPLO 22,22mm	FIAT	TIPO		1993/1997	S/ABS
C-2054	CILINDRO MESTRE DUPLO 25,40mm	AGRALE	1600 A/D RS/RD		1986/1989	
C-2054	CILINDRO MESTRE DUPLO 25,40mm	AGRALE	1800 D RS/RD		1988/1989	
C-2054	CILINDRO MESTRE DUPLO 25,40mm	GM - CHEVROLET	A-10		1985/1988	
C-2054	CILINDRO MESTRE DUPLO 25,40mm	GM - CHEVROLET	A-20		1985/1988	
C-2054	CILINDRO MESTRE DUPLO 25,40mm	GM - CHEVROLET	C-10/14/15/16		1985/1988	
C-2054	CILINDRO MESTRE DUPLO 25,40mm	GM - CHEVROLET	C-20		1985/1988	
C-2054	CILINDRO MESTRE DUPLO 25,40mm	GM - CHEVROLET	D-20		1985/1988	
C-2055	CILINDRO MESTRE DUPLO 20,63mm	VOLKSWAGEN	QUANTUM		1985/1990	
C-2057	CILINDRO MESTRE DUPLO 22,22mm	GM - CHEVROLET	IPANEMA		1990/1998	SIST. BOSCH
C-2057	CILINDRO MESTRE DUPLO 22,22mm	GM - CHEVROLET	KADETT		1989/1998	SIST. BOSCH
C-2057	CILINDRO MESTRE DUPLO 22,22mm	GM - CHEVROLET	MONZA		1988/1996	SIST. BOSCH
C-2058	CILINDRO MESTRE DUPLO 22,22mm	VOLKSWAGEN	GOL (G2)		1995/2000	MOTOR 2.0 8V/16V S/ABS
C-2058	CILINDRO MESTRE DUPLO 22,22mm	VOLKSWAGEN	GOL (G2)		2002/2005	MOTOR 1.6
C-2058	CILINDRO MESTRE DUPLO 22,22mm	VOLKSWAGEN	GOL (G3)		2000/2000	MOTOR 2.0 8V/16V S/ABS
C-2058	CILINDRO MESTRE DUPLO 22,22mm	VOLKSWAGEN	GOL (G3)		2001/2005	MOTOR 1.0/1.6/1.8/2.0 S/ABS
C-2058	CILINDRO MESTRE DUPLO 22,22mm	VOLKSWAGEN	GOL (G4)		2006/...	
C-2058	CILINDRO MESTRE DUPLO 22,22mm	VOLKSWAGEN	PARATI (G2, G3 e G4)		1996/2012	MOTOR 1.0/1.6/1.8/2.0 S/ABS
C-2058	CILINDRO MESTRE DUPLO 22,22mm	VOLKSWAGEN	SAVEIRO (G2, G3 e G4)		1998/2009	S/ABS
C-2059	CILINDRO MESTRE SIMPLES 19,05mm	VOLKSWAGEN	FUSCA		1957/1966	
C-2059	CILINDRO MESTRE SIMPLES 19,05mm	VOLKSWAGEN	KARMANN GHIA		1957/1966	
C-2060	CILINDRO MESTRE DUPLO 22,22mm	FORD	ROYALE		1995/1996	SIST. VARGA E BOSCH S/ABS
C-2060	CILINDRO MESTRE DUPLO 22,22mm	FORD	VERSAILLES		1995/1996	SIST. VARGA E BOSCH S/ABS
C-2060	CILINDRO MESTRE DUPLO 22,22mm	TROLLER	T4		1997/2001	
C-2060	CILINDRO MESTRE DUPLO 22,22mm	VOLKSWAGEN	QUANTUM		1995/2002	SIST. VARGA E BOSCH S/ABS
C-2060	CILINDRO MESTRE DUPLO 22,22mm	VOLKSWAGEN	SANTANA		1995/2006	SIST. VARGA E BOSCH S/ABS
C-2061	CILINDRO MESTRE DUPLO 22,22mm	FORD	FIESTA		1996/2002	MOTOR 1.0/1.3 SIST. VARGA
C-2061	CILINDRO MESTRE DUPLO 22,22mm	FORD	FIESTA STREET HATCH		2001/2007	MOTOR 1.0
C-2061	CILINDRO MESTRE DUPLO 22,22mm	FORD	KA		2008/...	MOTOR 1.0
C-2062	CILINDRO MESTRE DUPLO 28,57mm	FORD	F-1000		1992/1998	
C-2062	CILINDRO MESTRE DUPLO 28,57mm	FORD - CAMINHÕES	F-4000		1992/1998	SIST. BOSCH
C-2064	CILINDRO MESTRE DUPLO 23,81mm	GM - CHEVROLET	SPACE VAN		1997/1999	
C-2064	CILINDRO MESTRE DUPLO 23,81mm	GM - CHEVROLET	TRAFIC		1992/1998	
C-2064	CILINDRO MESTRE DUPLO 23,81mm	RENAULT	TRAFIC		1992/2003	
C-2065	CILINDRO MESTRE DUPLO 20,63mm	CITROËN	AX		1993/1996	MOD. GTI
C-2065	CILINDRO MESTRE DUPLO 20,63mm	CITROËN	ZX		1992/1997	1.6/1.8 SIST. TEVES S/ABS
C-2065	CILINDRO MESTRE DUPLO 20,63mm	PEUGEOT	106		1994/1996	S/ABS
C-2065	CILINDRO MESTRE DUPLO 20,63mm	PEUGEOT	205		1992/1998	
C-2065	CILINDRO MESTRE DUPLO 20,63mm	RENAULT	19		1992/1998	
C-2065	CILINDRO MESTRE DUPLO 20,63mm	RENAULT	CLIO		1996/1999	

Tabela de Conversão	Polegadas	9/16"	5/8"	11/16"	7/10"	3/4"	13/16"	7/8"	15/16"	1"	1 1/16"	1 1/8"	1 1/4"	1 3/8"	1 1/2"	1 5/8"	1 3/4"	1 27/32"	2"
	Milímetros		14,28mm	15,87mm	17,46mm	17,78mm	19,05mm	20,63mm	22,22mm	23,81mm	25,40mm	26,98mm	28,57mm	31,75mm	34,92mm	38,10mm	41,27mm	44,45mm	46,83mm

PEÇA	DESCRIÇÃO	MARCA	VEÍCULO		ANOS	SOMENTE PARA
C-2065	CILINDRO MESTRE DUPLO 20,63mm	RENAULT	EXPRESS		1998/2000	
C-2065	CILINDRO MESTRE DUPLO 20,63mm	RENAULT	MEGANE		1997/1999	S/ABS
C-2066	CILINDRO MESTRE DUPLO 20,63mm	FORD	ROYALE		1992/1994	S/ABS
C-2066	CILINDRO MESTRE DUPLO 20,63mm	VOLKSWAGEN	QUANTUM		1991/1994	S/ABS
C-2067	CILINDRO MESTRE DUPLO 20,63mm	SEAT	CORDOBA		1995/1999	S/ABS
C-2067	CILINDRO MESTRE DUPLO 20,63mm	SEAT	IBIZA		1995/1999	S/ABS
C-2067	CILINDRO MESTRE DUPLO 20,63mm	VOLKSWAGEN	GOLF		1995/1998	MOD. GL
C-2068	CILINDRO MESTRE DUPLO 23,81mm	TOYOTA	BANDEIRANTE		1982/1996	C/ <-
C-2069	CILINDRO MESTRE SIMPLES 22,22mm	MERCEDES BENZ - CAMINHÕES	L/LO-608 D/E		1976/1986	
C-2071	CILINDRO MESTRE DUPLO 22,22mm	GM - CHEVROLET	VECTRA		1997/2001	MOTOR 2.0/2.2 8V (EXCETO SIST. DELCO)
C-2073	CILINDRO MESTRE DUPLO 25,40mm	GM - CHEVROLET	BLAZER		1996/2011	S/ABS
C-2073	CILINDRO MESTRE DUPLO 25,40mm	GM - CHEVROLET	BLAZER		1996/2011	C/ABS NAS RODAS TRASEIRAS
C-2073	CILINDRO MESTRE DUPLO 25,40mm	GM - CHEVROLET	S-10		1995/2012	S/ABS
C-2073	CILINDRO MESTRE DUPLO 25,40mm	GM - CHEVROLET	S-10		1995/2012	C/ABS NAS RODAS TRASEIRAS
C-2073	CILINDRO MESTRE DUPLO 25,40mm	TROLLER	T4		2002/...	
C-2074	CILINDRO MESTRE DUPLO 22,22mm	SEAT	CORDOBA		2000/2002	S/ABS
C-2074	CILINDRO MESTRE DUPLO 22,22mm	SEAT	CORDOBA VARIO		2000/2002	S/ABS
C-2074	CILINDRO MESTRE DUPLO 22,22mm	SEAT	IBIZA		2000/2002	S/ABS
C-2074	CILINDRO MESTRE DUPLO 22,22mm	SEAT	INCA		1999/2002	
C-2074	CILINDRO MESTRE DUPLO 22,22mm	VOLKSWAGEN	GOLF		1994/1998	MOD. GLX/GTI S/ABS
C-2074	CILINDRO MESTRE DUPLO 22,22mm	VOLKSWAGEN	PASSAT		1991/1997	S/ABS
C-2074	CILINDRO MESTRE DUPLO 22,22mm	VOLKSWAGEN	PASSAT VARIANT		1991/1997	S/ABS
C-2074	CILINDRO MESTRE DUPLO 22,22mm	VOLKSWAGEN	POLO CLASSIC		1997/2002	S/ABS
C-2074	CILINDRO MESTRE DUPLO 22,22mm	VOLKSWAGEN	VAN		1999/2002	
C-2075	CILINDRO MESTRE DUPLO 22,22mm	FIAT	FIORINO (mod. Uno)		1994/...	SIST. ATE
C-2075	CILINDRO MESTRE DUPLO 22,22mm	FIAT	PALIO		1998/...	SIST. ATE S/ABS
C-2075	CILINDRO MESTRE DUPLO 22,22mm	FIAT	PALIO WEEKEND		1997/1998	MOTOR 1.6 16V S/ABS
C-2075	CILINDRO MESTRE DUPLO 22,22mm	FIAT	PALIO WEEKEND		1998/...	SIST. ATE S/ABS
C-2075	CILINDRO MESTRE DUPLO 22,22mm	FIAT	SIENA		1998/...	SIST. ATE S/ABS
C-2075	CILINDRO MESTRE DUPLO 22,22mm	FIAT	STRADA		1999/...	SIST. ATE S/ABS
C-2076	CILINDRO MESTRE SIMPLES 31,75mm	VOLKSWAGEN - CAMINHÕES	Jun-90		1982/1986	
C-2076	CILINDRO MESTRE SIMPLES 31,75mm	VOLKSWAGEN - CAMINHÕES	Jul-90		1987/1994	
C-2076	CILINDRO MESTRE SIMPLES 31,75mm	VOLKSWAGEN - CAMINHÕES	7-110 S		1988/1994	
C-2077	CILINDRO MESTRE SIMPLES 38,10mm	FORD - CAMINHÕES	F-4000		1988/1992	
C-2078	CILINDRO MESTRE DUPLO 28,57mm	GM - CAMINHÕES	D-40		1985/1997	
C-2079	CILINDRO MESTRE DUPLO 20,63mm	PEUGEOT	405		1992/1999	SIST. BENDIX S/ABS
C-2080	CILINDRO MESTRE DUPLO 23,81mm	CITROËN	JUMPER		1996/2002	S/ABS
C-2080	CILINDRO MESTRE DUPLO 23,81mm	FIAT	DUCATO		1998/1998	10/15 LUGARES S/ABS
C-2080	CILINDRO MESTRE DUPLO 23,81mm	FIAT	DUCATO		1999/2000	15/COMB./MINIBUS/MAXI S/TURBO S/ABS
C-2080	CILINDRO MESTRE DUPLO 23,81mm	FIAT	DUCATO		2002/2002	MINIBUS S/INTERCOOLER S/ABS
C-2080	CILINDRO MESTRE DUPLO 23,81mm	PEUGEOT	BOXER		1998/2002	S/ABS
C-2081	CILINDRO MESTRE DUPLO 20,63mm	FORD	KA		1997/1999	MOTOR 1.0/1.3 SIST. VARGA
C-2082	CILINDRO MESTRE DUPLO 20,63mm	GM - CHEVROLET	AGILE		2010/2011	S/ABS
C-2082	CILINDRO MESTRE DUPLO 20,63mm	GM - CHEVROLET	CORSA		1998/2002	SIST. ATE
C-2082	CILINDRO MESTRE DUPLO 20,63mm	GM - CHEVROLET	CORSA CLASSIC		2003/2009	
C-2082	CILINDRO MESTRE DUPLO 20,63mm	GM - CHEVROLET	CORSA PICK-UP		1998/2003	SIST. ATE
C-2082	CILINDRO MESTRE DUPLO 20,63mm	GM - CHEVROLET	MONTANA		2011/2013	S/ABS
C-2083	CILINDRO MESTRE DUPLO 22,22mm	GM - CHEVROLET	ASTRA		1995/1996	SIST. ATE
C-2083	CILINDRO MESTRE DUPLO 22,22mm	GM - CHEVROLET	VECTRA		1994/1996	SIST. ATE S/ABS
C-2084	CILINDRO MESTRE SIMPLES 22,22mm	GURGEL	E-400		1981/1983	
C-2084	CILINDRO MESTRE SIMPLES 22,22mm	GURGEL	X-20		1977/1979	
C-2084	CILINDRO MESTRE SIMPLES 22,22mm	VOLKSWAGEN	KOMBI		1957/1975	
C-2086	CILINDRO MESTRE SIMPLES 23,81mm	MERCEDES BENZ - CAMINHÕES	L/LO-708 D/E		1987/1988	
C-2087	CILINDRO MESTRE DUPLO 20,63mm	FIAT	147/SPAZIO		1983/1987	SIST. VARGA
C-2087	CILINDRO MESTRE DUPLO 20,63mm	FIAT	FIORINO (mod. 147)		1983/1988	SIST. VARGA
C-2087	CILINDRO MESTRE DUPLO 20,63mm	FIAT	OGGI		1983/1985	SIST. VARGA
C-2087	CILINDRO MESTRE DUPLO 20,63mm	FIAT	PANORAMA		1983/1987	SIST. VARGA
C-2088	CILINDRO MESTRE DUPLO 28,57mm	GM - CHEVROLET	BONANZA		1993/1996	MOTOR 4.0 TURBO
C-2088	CILINDRO MESTRE DUPLO 28,57mm	GM - CHEVROLET	D-20		1993/1996	MOTOR 4.0 TURBO
C-2088	CILINDRO MESTRE DUPLO 28,57mm	GM - CHEVROLET	VERANEIO		1993/1996	MOTOR 4.0 TURBO
C-2089	CILINDRO MESTRE DUPLO 22,22mm	ASIA	TOPIC		1993/1999	
C-2089	CILINDRO MESTRE DUPLO 22,22mm	KIA	BESTA		1993/1998	MOD. 2.2/2.7

Tabela de Conversão	Polegadas	9/16"	5/8"	11/16"	7/10"	3/4"	13/16"	7/8"	15/16"	1"	1 1/16"	1 1/8"	1 1/4"	1 3/8"	1 1/2"	1 5/8"	1 3/4"	1 27/32"	2"
	Milímetros	14,28mm	15,87mm	17,46mm	17,78mm	19,05mm	20,63mm	22,22mm	23,81mm	25,40mm	26,98mm	28,57mm	31,75mm	34,92mm	38,10mm	41,27mm	44,45mm	46,83mm	50,80mm



PEÇA	DESCRIÇÃO	MARCA	VEÍCULO		ANOS	SOMENTE PARA
C-2090	CILINDRO MESTRE DUPLO 23,81mm	MERCEDES BENZ	SPRINTER		1997/2000	MOD. 310
C-2091	CILINDRO MESTRE DUPLO 23,81mm	FORD	COURIER		1998/...	
C-2091	CILINDRO MESTRE DUPLO 23,81mm	FORD	FIESTA		1996/2002	MOTOR 1.4/1.6 SIST. VARGA
C-2091	CILINDRO MESTRE DUPLO 23,81mm	FORD	FIESTA STREET HATCH		2002/2007	MOTOR 1.6
C-2091	CILINDRO MESTRE DUPLO 23,81mm	FORD	FIESTA STREET SEDAN		2002/2004	
C-2091	CILINDRO MESTRE DUPLO 23,81mm	FORD	KA		2008/...	MOTOR 1.6
C-2092	CILINDRO MESTRE DUPLO 20,63mm	GM - CHEVROLET	CELTA		2001/2005	
C-2093	CILINDRO MESTRE DUPLO 20,63mm	FORD	KA		2000/2007	MOTOR 1.0
C-2094	CILINDRO MESTRE DUPLO 22,22mm	GM - CHEVROLET	ASTRA		1999/2001	MOD. GL S/ABS
C-2094	CILINDRO MESTRE DUPLO 22,22mm	GM - CHEVROLET	ASTRA		2002/2011	S/ABS
C-2095	CILINDRO MESTRE DUPLO 23,81mm	AUDI	A3		1997/2006	
C-2095	CILINDRO MESTRE DUPLO 23,81mm	AUDI	TT		1999/2006	
C-2095	CILINDRO MESTRE DUPLO 23,81mm	VOLKSWAGEN	BORA		2001/2007	
C-2095	CILINDRO MESTRE DUPLO 23,81mm	VOLKSWAGEN	GOLF		1999/...	
C-2095	CILINDRO MESTRE DUPLO 23,81mm	VOLKSWAGEN	NEW BEETLE		2000/2005	
C-2096	CILINDRO MESTRE DUPLO 20,63mm	RENAULT	CLIO		2000/...	S/ABS
C-2096	CILINDRO MESTRE DUPLO 20,63mm	RENAULT	SYMBOL		2009/...	S/ABS
C-2097	CILINDRO MESTRE DUPLO 23,81mm	GM - CHEVROLET	ASTRA		1999/2001	MOD. GLS
C-2097	CILINDRO MESTRE DUPLO 23,81mm	GM - CHEVROLET	ASTRA		1999/2001	MOD. GL C/ABS
C-2097	CILINDRO MESTRE DUPLO 23,81mm	GM - CHEVROLET	ASTRA		2002/2011	C/ABS
C-2097	CILINDRO MESTRE DUPLO 23,81mm	GM - CHEVROLET	MERIVA		2003/2012	
C-2097	CILINDRO MESTRE DUPLO 23,81mm	GM - CHEVROLET	VECTRA		2006/2011	
C-2097	CILINDRO MESTRE DUPLO 23,81mm	GM - CHEVROLET	ZAFIRA		2002/2012	
C-2098	CILINDRO MESTRE DUPLO 23,81mm	GM - CHEVROLET	VECTRA		1997/2001	MOTOR 2.0/2.2 16V
C-2099	CILINDRO MESTRE DUPLO 22,22mm	FORD	ROYALE		1992/1996	C/ABS
C-2099	CILINDRO MESTRE DUPLO 22,22mm	FORD	VERSAILLES		1992/1996	C/ABS
C-2099	CILINDRO MESTRE DUPLO 22,22mm	VOLKSWAGEN	GOL (G2)		1995/2000	C/ABS
C-2099	CILINDRO MESTRE DUPLO 22,22mm	VOLKSWAGEN	GOL (G3)		2000/2004	MOTOR 1.0 TURBO
C-2099	CILINDRO MESTRE DUPLO 22,22mm	VOLKSWAGEN	GOL (G3)		2000/2005	C/ABS
C-2099	CILINDRO MESTRE DUPLO 22,22mm	VOLKSWAGEN	PARATI (G2, G3 e G4)		1996/2012	C/ABS
C-2099	CILINDRO MESTRE DUPLO 22,22mm	VOLKSWAGEN	PARATI (G2, G3 e G4)		2000/2004	MOTOR 1.0 TURBO
C-2099	CILINDRO MESTRE DUPLO 22,22mm	VOLKSWAGEN	QUANTUM		1992/2002	C/ABS
C-2099	CILINDRO MESTRE DUPLO 22,22mm	VOLKSWAGEN	SANTANA		1992/2006	C/ABS
C-2099	CILINDRO MESTRE DUPLO 22,22mm	VOLKSWAGEN	SAVEIRO (G2, G3 e G4)		1999/2009	C/ABS
C-2128	CILINDRO MESTRE DUPLO 23,81mm	RENAULT	SCENIC		1999/2011	S/ABS
C-2128	CILINDRO MESTRE DUPLO 23,81mm	TROLLER	T4		2001/2002	
C-2129	CILINDRO MESTRE DUPLO 26,98mm	FORD	EXPLORER		1998/2005	
C-2129	CILINDRO MESTRE DUPLO 26,98mm	FORD	RANGER		1998/2001	
C-2129	CILINDRO MESTRE DUPLO 26,98mm	FORD	RANGER		2001/2005	MOTOR 4.0 V6
C-2129	CILINDRO MESTRE DUPLO 26,98mm	MAZDA	B-2500		1998/2000	
C-2130	CILINDRO MESTRE DUPLO 20,63mm	PEUGEOT	206		1999/2001	MOTOR 1.6 8V S/ABS
C-2130	CILINDRO MESTRE DUPLO 20,63mm	PEUGEOT	206		2001/2004	MOTOR 1.0 16V S/ABS
C-2130	CILINDRO MESTRE DUPLO 20,63mm	PEUGEOT	206		2005/2010	MOTOR 1.4 8V S/ABS
C-2130	CILINDRO MESTRE DUPLO 20,63mm	PEUGEOT	206 SW		2005/2008	MOTOR 1.4 8V S/ABS
C-2130	CILINDRO MESTRE DUPLO 20,63mm	PEUGEOT	207		2009/...	MOTOR 1.4 8V S/ABS
C-2130	CILINDRO MESTRE DUPLO 20,63mm	PEUGEOT	207 PASSION		2009/...	MOTOR 1.4 8V S/ABS
C-2130	CILINDRO MESTRE DUPLO 20,63mm	PEUGEOT	207 SW		2009/...	MOTOR 1.4 8V S/ABS
C-2130	CILINDRO MESTRE DUPLO 20,63mm	PEUGEOT	306		1994/1997	SIST. ATE S/ABS
C-2131	CILINDRO MESTRE DUPLO 23,81mm C/ RESERV.	HYUNDAI	GALLOPER		1998/1999	MOTOR 3.0 V6 S/ABS
C-2131	CILINDRO MESTRE DUPLO 23,81mm C/ RESERV.	MITSUBISHI	L200		1992/2006	L/GL/GLS
C-2131	CILINDRO MESTRE DUPLO 23,81mm C/ RESERV.	MITSUBISHI	L200		2003/2012	HPE/SPORT/OUTDOOR S/ABS
C-2131	CILINDRO MESTRE DUPLO 23,81mm C/ RESERV.	MITSUBISHI	PAJERO		1992/2005	S/ABS
C-2132	CILINDRO MESTRE DUPLO 26,98mm C / RESERV.	FORD	EXPLORER		1995/1997	
C-2132	CILINDRO MESTRE DUPLO 26,98mm C / RESERV.	FORD	RANGER		1995/1997	MOTOR 6 CIL.
C-2133	CILINDRO MESTRE DUPLO 22,22mm	FIAT	TEMPRA		1993/1999	MOTOR 2.0 16V C/ABS
C-2133	CILINDRO MESTRE DUPLO 22,22mm	FIAT	TEMPRA		1995/1998	MOTOR 2.0 TURBO C/ CIL. BENDIX C/ABS
C-2134	CILINDRO MESTRE DUPLO 25,40mm C/ RESERV.	GM - CHEVROLET	C-10/14/15/16		1973/1978	
C-2134	CILINDRO MESTRE DUPLO 25,40mm C/ RESERV.	GM - CHEVROLET	VERANEIO		1973/1978	
C-2135	CILINDRO MESTRE DUPLO 20,63mm	RENAULT	TWINGO		1994/2002	S/ABS
C-2137	CILINDRO MESTRE DUPLO 25,40mm	FIAT	DUCATO		1998/1998	8/10 S/ABS
C-2137	CILINDRO MESTRE DUPLO 25,40mm	FIAT	DUCATO		1999/2001	15/COMB./MINIBUS/MAXI TURBO S/ABS
C-2137	CILINDRO MESTRE DUPLO 25,40mm	FIAT	DUCATO		2002/2002	15/COMB./MINIBUS/MAXI TD INTERC. S/ ABS

Tabela de Conversão	Polegadas	9/16"	5/8"	11/16"	7/10"	3/4"	13/16"	7/8"	15/16"	1"	1 1/16"	1 1/8"	1 1/4"	1 3/8"	1 1/2"	1 5/8"	1 3/4"	1 27/32"	2"
	Milímetros	14,28mm	15,87mm	17,46mm	17,78mm	19,05mm	20,63mm	22,22mm	23,81mm	25,40mm	26,98mm	28,57mm	31,75mm	34,92mm	38,10mm	41,27mm	44,45mm	46,83mm	50,80mm

PEÇA	DESCRIÇÃO	MARCA	VEÍCULO		ANOS	SOMENTE PARA
C-2138	CILINDRO MESTRE DUPLO 22,22mm	CITROËN	XSARA		1998/2000	S/ABS
C-2138	CILINDRO MESTRE DUPLO 22,22mm	PEUGEOT	206		2001/2008	MOTOR 1.6 16V S/ABS
C-2138	CILINDRO MESTRE DUPLO 22,22mm	PEUGEOT	206 SW		2005/2008	MOTOR 1.6 16V S/ABS
C-2138	CILINDRO MESTRE DUPLO 22,22mm	PEUGEOT	207		2009/...	MOTOR 1.6 16V S/ABS
C-2138	CILINDRO MESTRE DUPLO 22,22mm	PEUGEOT	207 PASSION		2009/...	MOTOR 1.6 16V S/ABS
C-2138	CILINDRO MESTRE DUPLO 22,22mm	PEUGEOT	207 SW		2009/...	MOTOR 1.6 16V S/ABS
C-2138	CILINDRO MESTRE DUPLO 22,22mm	PEUGEOT	306		1998/2002	SIST. ATE S/ABS
C-2139	CILINDRO MESTRE DUPLO 22,22mm	FIAT	DOBLÒ		2002/...	S/ABS
C-2140	CILINDRO MESTRE DUPLO 22,22mm	FIAT	TEMPRA		1995/1998	MOTOR 2.0 TURBO C/ CIL. BENDIX S/ABS
C-2141	CILINDRO MESTRE DUPLO 23,81mm	GM - CHEVROLET	VECTRA		2002/2005	
C-2142	CILINDRO MESTRE DUPLO 23,81mm	FIAT	BRAVA		2000/2003	MOTOR 1.8 16V
C-2142	CILINDRO MESTRE DUPLO 23,81mm	FIAT	MAREA		1999/2007	MOTOR 2.0/2.4 20V
C-2142	CILINDRO MESTRE DUPLO 23,81mm	FIAT	MAREA		1999/2007	MOTOR 2.0 TURBO 20V
C-2142	CILINDRO MESTRE DUPLO 23,81mm	FIAT	MAREA		2000/2007	MOTOR 1.8 16V
C-2142	CILINDRO MESTRE DUPLO 23,81mm	FIAT	MAREA WEEKEND		1999/2007	MOTOR 2.0/2.4 20V
C-2142	CILINDRO MESTRE DUPLO 23,81mm	FIAT	MAREA WEEKEND		1999/2007	MOTOR 2.0 TURBO 20V
C-2142	CILINDRO MESTRE DUPLO 23,81mm	FIAT	MAREA WEEKEND		2000/2007	MOTOR 1.8 16V
C-2143	CILINDRO MESTRE DUPLO 22,22mm	GM - CHEVROLET	CORSA		2002/2012	S/ABS
C-2143	CILINDRO MESTRE DUPLO 22,22mm	GM - CHEVROLET	MONTANA		2004/2010	S/ABS
C-2146	CILINDRO MESTRE DUPLO 23,81mm	FORD	FOCUS		2001/2003	SIST. BOSCH S/ABS
C-2148	CILINDRO MESTRE DUPLO 25,40mm	MERCEDES BENZ	SPRINTER		2000/2004	MOD. 312/412
C-2149	CILINDRO MESTRE DUPLO 31,75mm	MERCEDES BENZ - CAMINHÕES	L-709		1989/1996	
C-2149	CILINDRO MESTRE DUPLO 31,75mm	MERCEDES BENZ - CAMINHÕES	L-710		1996/2002	
C-2154	CILINDRO MESTRE SIMPLES 22,22mm	MERCEDES BENZ - CAMINHÕES	L/LO-608 D/E		1972/1975	
C-2155	CILINDRO MESTRE DUPLO 23,81mm	FORD	ECOSPORT		2003/2012	S/ABS
C-2155	CILINDRO MESTRE DUPLO 23,81mm	FORD	FIESTA		2003/...	MOTOR 1.6/1.0 SUPERCHARGER S/ABS
C-2155	CILINDRO MESTRE DUPLO 23,81mm	FORD	FIESTA SEDAN		2005/...	MOTOR 1.6/1.0 SUPERCHARGER S/ABS
C-2156	CILINDRO MESTRE DUPLO 22,22mm	FORD	FIESTA		2003/...	MOTOR 1.0
C-2156	CILINDRO MESTRE DUPLO 22,22mm	FORD	FIESTA SEDAN		2005/...	MOTOR 1.0
C-2157	CILINDRO MESTRE DUPLO 20,63mm	GM - CHEVROLET	CELTA		2005/2007	
C-2159	CILINDRO MESTRE SIMPLES 34,92mm	MERCEDES BENZ - CAMINHÕES	0-355		1970/1978	
C-2159	CILINDRO MESTRE SIMPLES 34,92mm	MERCEDES BENZ - CAMINHÕES	0/OH-362/362 A		1978/1989	MOD. 0
C-2159	CILINDRO MESTRE SIMPLES 34,92mm	MERCEDES BENZ - CAMINHÕES	0-364		1978/1981	
C-2159	CILINDRO MESTRE SIMPLES 34,92mm	MERCEDES BENZ - CAMINHÕES	0-364		1982/1989	CIRCUITO TRASEIRO
C-2159	CILINDRO MESTRE SIMPLES 34,92mm	MERCEDES BENZ - CAMINHÕES	L/LA/LK/LS/OF-1113		1983/1989	MOD. L
C-2159	CILINDRO MESTRE SIMPLES 34,92mm	MERCEDES BENZ - CAMINHÕES	L-1116		1983/1989	
C-2159	CILINDRO MESTRE SIMPLES 34,92mm	MERCEDES BENZ - CAMINHÕES	L/LS/LK/OF/OH-1313		1983/1989	
C-2159	CILINDRO MESTRE SIMPLES 34,92mm	MERCEDES BENZ - CAMINHÕES	OH-1416		1970/1989	
C-2159	CILINDRO MESTRE SIMPLES 34,92mm	MERCEDES BENZ - CAMINHÕES	L/LP/OH-1419		1970/1989	
C-2159	CILINDRO MESTRE SIMPLES 34,92mm	MERCEDES BENZ - CAMINHÕES	L/LK-1513/1516		1971/1976	
C-2159	CILINDRO MESTRE SIMPLES 34,92mm	MERCEDES BENZ - CAMINHÕES	L-1519		1973/1976	
C-2159	CILINDRO MESTRE SIMPLES 34,92mm	MERCEDES BENZ - CAMINHÕES	L/LB/LK-2213		1973/1990	
C-2160	CILINDRO MESTRE DUPLO 20,63mm	VOLKSWAGEN	CROSSFOX		2005/...	S/ABS
C-2160	CILINDRO MESTRE DUPLO 20,63mm	VOLKSWAGEN	FOX		2004/...	S/ABS C/DISCO 256x22mm
C-2160	CILINDRO MESTRE DUPLO 20,63mm	VOLKSWAGEN	POLO		2002/...	S/ABS
C-2160	CILINDRO MESTRE DUPLO 20,63mm	VOLKSWAGEN	SPACEFOX		2006/...	S/ABS
C-2160	CILINDRO MESTRE DUPLO 20,63mm	VOLKSWAGEN	SPACE CROSS		2012/...	S/ABS
C-2161	CILINDRO MESTRE DUPLO 20,63mm	TOYOTA	COROLLA		2003/2008	
C-2161	CILINDRO MESTRE DUPLO 20,63mm	TOYOTA	COROLLA FIELDER		2004/2008	
C-2162	CILINDRO MESTRE DUPLO 25,40mm	KIA	BESTA		1998/2005	MOD. GS
C-2163	CILINDRO MESTRE DUPLO 25,40mm	CITROËN	JUMPER		2003/...	S/ABS
C-2163	CILINDRO MESTRE DUPLO 25,40mm	FIAT	DUCATO		2003/...	S/ABS
C-2163	CILINDRO MESTRE DUPLO 25,40mm	PEUGEOT	BOXER		2003/...	S/ABS
C-2164	CILINDRO MESTRE DUPLO 23,81mm	HYUNDAI	H-100		1995/2004	
C-2165	CILINDRO MESTRE DUPLO 22,22mm	RENAULT	KANGOO		2000/...	S/ABS
C-2166	CILINDRO MESTRE DUPLO 25,40mm	MERCEDES BENZ	SPRINTER		2002/...	MOD. 311/313/413
C-2167	CILINDRO MESTRE DUPLO 25,40mm	IVECO	DAILY		1997/2007	MOD. 35.10
C-2167	CILINDRO MESTRE DUPLO 25,40mm	IVECO	DAILY		2008/...	MOD. 35S14/45S14
C-2168	CILINDRO MESTRE DUPLO 20,63mm	GM - CHEVROLET	CELTA		2007/...	
C-2168	CILINDRO MESTRE DUPLO 20,63mm	GM - CHEVROLET	PRISMA		2007/2012	
C-2169	CILINDRO MESTRE SIMPLES 31,75mm	MERCEDES BENZ - CAMINHÕES	LO-814		1996/...	
C-2169	CILINDRO MESTRE SIMPLES 31,75mm	MERCEDES BENZ - CAMINHÕES	L/LO-912		1996/...	SIST. VARGA

Tabela de Conversão	Polegadas	9/16"	5/8"	11/16"	7/10"	3/4"	13/16"	7/8"	15/16"	1"	1 1/16"	1 1/8"	1 1/4"	1 3/8"	1 1/2"	1 5/8"	1 3/4"	1 27/32"	2"
	Milímetros	14,28mm	15,87mm	17,46mm	17,78mm	19,05mm	20,63mm	22,22mm	23,81mm	25,40mm	26,98mm	28,57mm	31,75mm	34,92mm	38,10mm	41,27mm	44,45mm	46,83mm	50,80mm



PEÇA	DESCRIÇÃO	MARCA	VEÍCULO		ANOS	SOMENTE PARA
C-2169	CILINDRO MESTRE SIMPLES 31,75mm	MERCEDES BENZ - CAMINHÕES	L-914/914 E		1996/...	
C-2169	CILINDRO MESTRE SIMPLES 31,75mm	MERCEDES BENZ - CAMINHÕES	L-1114		1996/...	
C-2170	CILINDRO MESTRE DUPLO 22,22mm	HONDA	CIVIC		2001/2006	
C-2171	CILINDRO MESTRE DUPLO 23,81mm	CITROËN	BERLINGO		2001/2007	S/ABS
C-2171	CILINDRO MESTRE DUPLO 23,81mm	CITROËN	XSARA		2001/2003	S/ABS
C-2171	CILINDRO MESTRE DUPLO 23,81mm	CITROËN	XSARA BREAK		1997/2001	S/ABS
C-2171	CILINDRO MESTRE DUPLO 23,81mm	CITROËN	XSARA PICASSO		2001/2012	S/ABS
C-2171	CILINDRO MESTRE DUPLO 23,81mm	PEUGEOT	306 BREAK		1996/2001	S/ABS
C-2171	CILINDRO MESTRE DUPLO 23,81mm	PEUGEOT	PARTNER		2001/...	S/ABS
C-2172	CILINDRO MESTRE DUPLO 20,63mm	CITROËN	C3		2002/2012	S/ABS
C-2173	CILINDRO MESTRE DUPLO 20,63mm	VOLKSWAGEN	GOL (G5)		2009/2012	SIST. ATE S/ABS
C-2173	CILINDRO MESTRE DUPLO 20,63mm	VOLKSWAGEN	SAVEIRO (G5)		2010/2013	SIST. ATE S/ABS
C-2173	CILINDRO MESTRE DUPLO 20,63mm	VOLKSWAGEN	VOYAGE (G5)		2009/2013	SIST. ATE S/ABS
C-2174	CILINDRO MESTRE DUPLO 20,63mm	GM - CHEVROLET	AGILE		2012/...	S/ABS
C-2174	CILINDRO MESTRE DUPLO 20,63mm	GM - CHEVROLET	CORSA CLASSIC		2010/...	
C-2175	CILINDRO MESTRE DUPLO 23,81mm	FORD	FOCUS		2003/2009	SIST. ATE S/ABS
C-2176	CILINDRO MESTRE DUPLO 22,22mm	FIAT	IDEA		2006/...	S/ABS
C-2177	CILINDRO MESTRE DUPLO 20,63mm	HONDA	FIT		2003/2008	C/ABS
C-2178	CILINDRO MESTRE DUPLO 20,63mm	RENAULT	LOGAN		2007/...	S/ABS
C-2178	CILINDRO MESTRE DUPLO 20,63mm	RENAULT	SANDERO		2008/...	S/ABS
C-2179	CILINDRO MESTRE DUPLO 23,81mm C/RESERV.	HYUNDAI	GALLOPER		1998/1999	C/ABS
C-2179	CILINDRO MESTRE DUPLO 23,81mm C/RESERV.	MITSUBISHI	L200		2003/...	SPORT/AUTOMÁTICA
C-2179	CILINDRO MESTRE DUPLO 23,81mm C/RESERV.	MITSUBISHI	PAJERO		2006/...	SPORT HPE/DIESEL
C-2180	CILINDRO MESTRE DUPLO 20,63mm	HONDA	CIVIC		1998/2000	S/ABS
C-2181	CILINDRO MESTRE DUPLO 22,22mm	FIAT	UNO		2011/...	MOTOR 1.4 S/ABS
C-2181	CILINDRO MESTRE DUPLO 22,22mm	FIAT	UNO WAY		2011/...	MOTOR 1.0
C-2182	CILINDRO MESTRE DUPLO 20,63mm	FIAT	UNO VIVACE		2011/...	MOTOR 1.0 S/ABS
C-2183	CILINDRO MESTRE DUPLO 19,05mm	HONDA	NEW CIVIC		2007/2011	
C-2185	CILINDRO MESTRE DUPLO 25,40mm	FORD	FOCUS		2008/2010	2.0 COM ABS
C-2192	CILINDRO MESTRE DUPLO 23,81 / 25,40mm	RENAULT	MASTER		1998/2001	2.8 dTI
C-2192	CILINDRO MESTRE DUPLO 23,81 / 25,40mm	RENAULT	MASTER		2001/2005	2.5 dCI
C-2193	CILINDRO MESTRE DUPLO 23,81mm	CITROËN	C4		2004/2007	2.0 VTR 16V
C-2193	CILINDRO MESTRE DUPLO 23,81mm	CITROËN	C4		2006/2009	2.0 16V
C-2193	CILINDRO MESTRE DUPLO 23,81mm	PEUGEOT	307		2000/2006	2.0 16V RALLYE COM ESP
C-2193	CILINDRO MESTRE DUPLO 23,81mm	PEUGEOT	307		2001/...	1.6 PASSION COM ESP
C-2193	CILINDRO MESTRE DUPLO 23,81mm	PEUGEOT	307		2002/2008	SW 2.0 16V COM ESP
C-2193	CILINDRO MESTRE DUPLO 23,81mm	PEUGEOT	307		2003/2009	CC 2.0 16V
C-2193	CILINDRO MESTRE DUPLO 23,81mm	PEUGEOT	307		2006/...	2.0 16V COM ESP
C-2193	CILINDRO MESTRE DUPLO 23,81mm	PEUGEOT	307		2006/2007	1.6 COM ESP

Tabela de Conversão	Polegadas	9/16"	5/8"	11/16"	7/10"	3/4"	13/16"	7/8"	15/16"	1"	1 1/16"	1 1/8"	1 1/4"	1 3/8"	1 1/2"	1 5/8"	1 3/4"	1 27/32"	2"
	Milímetros		14,28mm	15,87mm	17,46mm	17,78mm	19,05mm	20,63mm	22,22mm	23,81mm	25,40mm	26,98mm	28,57mm	31,75mm	34,92mm	38,10mm	41,27mm	44,45mm	46,83mm



---

## CILINDRO DE EMBREAGEM

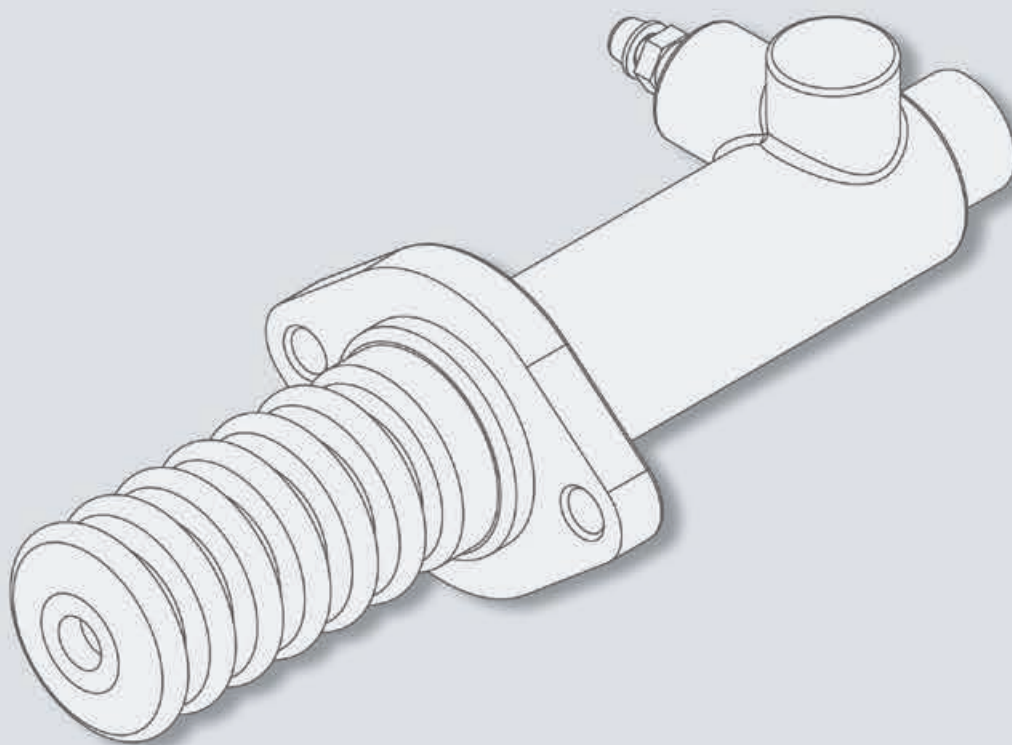

PEÇA	DESCRIÇÃO	MARCA	VEÍCULO		ANOS	SOMENTE PARA
C-2600	CILINDRO MESTRE DE EMBREAGEM 19,05mm	MERCEDES BENZ - CAMINHÕES	L/LO-608 D/E		1976/1986	
C-2600	CILINDRO MESTRE DE EMBREAGEM 19,05mm	MERCEDES BENZ - CAMINHÕES	L/LO-708 D/E		1987/1988	
C-2601	CILINDRO MESTRE DE EMBREAGEM 19,05mm	MERCEDES BENZ - CAMINHÕES	0-370		1984/...	MOD. R/RS
C-2601	CILINDRO MESTRE DE EMBREAGEM 19,05mm	MERCEDES BENZ - CAMINHÕES	L/LS-1932/1933/1934		1984/...	MOD. L/LS
C-2602	CILINDRO MESTRE DE EMBREAGEM 19,05mm	MERCEDES BENZ - CAMINHÕES	L-709		1989/1996	
C-2602	CILINDRO MESTRE DE EMBREAGEM 19,05mm	MERCEDES BENZ - CAMINHÕES	L-710		1996/...	
C-2602	CILINDRO MESTRE DE EMBREAGEM 19,05mm	MERCEDES BENZ - CAMINHÕES	LO/OF-809		1989/...	
C-2602	CILINDRO MESTRE DE EMBREAGEM 19,05mm	MERCEDES BENZ - CAMINHÕES	L/LO/OF-812		1989/...	
C-2602	CILINDRO MESTRE DE EMBREAGEM 19,05mm	MERCEDES BENZ - CAMINHÕES	L/LO-912		1989/...	
C-2602	CILINDRO MESTRE DE EMBREAGEM 19,05mm	MERCEDES BENZ - CAMINHÕES	LS-1630/1635		1991/...	
C-2602	CILINDRO MESTRE DE EMBREAGEM 19,05mm	MERCEDES BENZ - CAMINHÕES	L/LS/LK-1929		1991/...	MOD. L/LS
C-2602	CILINDRO MESTRE DE EMBREAGEM 19,05mm	MERCEDES BENZ - CAMINHÕES	L/LS/LK-1935		1991/...	MOD. L/LS
C-2602	CILINDRO MESTRE DE EMBREAGEM 19,05mm	MERCEDES BENZ - CAMINHÕES	LS-1938		1991/...	
C-2602	CILINDRO MESTRE DE EMBREAGEM 19,05mm	MERCEDES BENZ - CAMINHÕES	L/LS/LK-1941		1991/...	MOD. L/LS
C-2603	CILINDRO MESTRE DE EMBREAGEM 23,81mm	MERCEDES BENZ - CAMINHÕES	0-370		1984/...	
C-2603	CILINDRO MESTRE DE EMBREAGEM 23,81mm	MERCEDES BENZ - CAMINHÕES	0-371		1984/...	
C-2603	CILINDRO MESTRE DE EMBREAGEM 23,81mm	MERCEDES BENZ - CAMINHÕES	OF/OH-1318		1987/...	
C-2604	CILINDRO MESTRE DE EMBREAGEM 22,22mm	FORD - CAMINHÕES	CARGO		1985/...	
C-2605	CILINDRO MESTRE DE EMBREAGEM 22,22mm	AGRALE	4500/5000		1994/1998	
C-2605	CILINDRO MESTRE DE EMBREAGEM 22,22mm	AGRALE	6000		1999/...	
C-2605	CILINDRO MESTRE DE EMBREAGEM 22,22mm	AGRALE	7000/7500		1993/2005	
C-2605	CILINDRO MESTRE DE EMBREAGEM 22,22mm	AGRALE	8500		1997/...	
C-2605	CILINDRO MESTRE DE EMBREAGEM 22,22mm	AGRALE	9200 TCA		2003/...	
C-2605	CILINDRO MESTRE DE EMBREAGEM 22,22mm	AGRALE	FURGOVAN		2002/...	
C-2605	CILINDRO MESTRE DE EMBREAGEM 22,22mm	AGRALE	MA 5.0/6.0/7.5/8.0/8.5/9.2		1996/...	
C-2605	CILINDRO MESTRE DE EMBREAGEM 22,22mm	AGRALE	VOLARE A5/V5		2002/2004	
C-2605	CILINDRO MESTRE DE EMBREAGEM 22,22mm	AGRALE	VOLARE A6/V6		1998/2004	
C-2605	CILINDRO MESTRE DE EMBREAGEM 22,22mm	AGRALE	VOLARE A8/V8		2000/2004	
C-2605	CILINDRO MESTRE DE EMBREAGEM 22,22mm	AGRALE	VOLARE W8		2002/2004	
C-2605	CILINDRO MESTRE DE EMBREAGEM 22,22mm	FORD - CAMINHÕES	B-1618/1621		1993/1996	
C-2605	CILINDRO MESTRE DE EMBREAGEM 22,22mm	FORD - CAMINHÕES	F-12000		1996/1998	
C-2605	CILINDRO MESTRE DE EMBREAGEM 22,22mm	FORD - CAMINHÕES	F-14000		1996/1998	
C-2605	CILINDRO MESTRE DE EMBREAGEM 22,22mm	VOLKSWAGEN - CAMINHÕES	7-100		1994/1999	
C-2605	CILINDRO MESTRE DE EMBREAGEM 22,22mm	VOLKSWAGEN - CAMINHÕES	8-100		1997/2000	
C-2605	CILINDRO MESTRE DE EMBREAGEM 22,22mm	VOLKSWAGEN - CAMINHÕES	8-140 CE/CO		1994/1999	
C-2605	CILINDRO MESTRE DE EMBREAGEM 22,22mm	VOLKSWAGEN - CAMINHÕES	12-140H		1989/1998	
C-2605	CILINDRO MESTRE DE EMBREAGEM 22,22mm	VOLKSWAGEN - CAMINHÕES	14-150		1991/2000	
C-2605	CILINDRO MESTRE DE EMBREAGEM 22,22mm	VOLKSWAGEN - CAMINHÕES	14-200		1991/1994	
C-2605	CILINDRO MESTRE DE EMBREAGEM 22,22mm	VOLKSWAGEN - CAMINHÕES	14-210		1987/1991	
C-2605	CILINDRO MESTRE DE EMBREAGEM 22,22mm	VOLKSWAGEN - CAMINHÕES	14-220		1992/2000	
C-2605	CILINDRO MESTRE DE EMBREAGEM 22,22mm	VOLKSWAGEN - CAMINHÕES	16-170		1991/1999	
C-2605	CILINDRO MESTRE DE EMBREAGEM 22,22mm	VOLKSWAGEN - CAMINHÕES	16-210		1989/1991	
C-2605	CILINDRO MESTRE DE EMBREAGEM 22,22mm	VOLKSWAGEN - CAMINHÕES	16-220		1991/2000	
C-2605	CILINDRO MESTRE DE EMBREAGEM 22,22mm	VOLKSWAGEN - CAMINHÕES	24-220		1991/1999	
C-2605	CILINDRO MESTRE DE EMBREAGEM 22,22mm	VOLKSWAGEN - CAMINHÕES	24-250		1992/1999	
C-2605	CILINDRO MESTRE DE EMBREAGEM 22,22mm	VOLKSWAGEN - CAMINHÕES	35-300		1991/1999	
C-2606	CILINDRO MESTRE DE EMBREAGEM 22,22mm	TOYOTA	BANDEIRANTE		1987/1994	
C-2606	CILINDRO MESTRE DE EMBREAGEM 22,22mm	TROLLER	T4		2002/...	
C-2607	CILINDRO MESTRE DE EMBREAGEM 23,81mm	MERCEDES BENZ - CAMINHÕES	0-371		1987/...	
C-2607	CILINDRO MESTRE DE EMBREAGEM 23,81mm	MERCEDES BENZ - CAMINHÕES	L/LP/OH-1419		1980/...	
C-2607	CILINDRO MESTRE DE EMBREAGEM 23,81mm	MERCEDES BENZ - CAMINHÕES	OH-1420		1980/...	
C-2607	CILINDRO MESTRE DE EMBREAGEM 23,81mm	MERCEDES BENZ - CAMINHÕES	L/LP-1614		1989/...	
C-2607	CILINDRO MESTRE DE EMBREAGEM 23,81mm	MERCEDES BENZ - CAMINHÕES	L/LK-1618		1989/...	
C-2608	CILINDRO MESTRE DE EMBREAGEM 19,05mm	VOLKSWAGEN - CAMINHÕES	Jun-80		1982/1986	
C-2608	CILINDRO MESTRE DE EMBREAGEM 19,05mm	VOLKSWAGEN - CAMINHÕES	Jun-90		1982/1986	
C-2608	CILINDRO MESTRE DE EMBREAGEM 19,05mm	VOLKSWAGEN - CAMINHÕES	Jul-90		1987/1994	
C-2608	CILINDRO MESTRE DE EMBREAGEM 19,05mm	VOLKSWAGEN - CAMINHÕES	7-110 S		1988/1994	
C-2608	CILINDRO MESTRE DE EMBREAGEM 19,05mm	VOLKSWAGEN - CAMINHÕES	11-130		1982/1985	
C-2608	CILINDRO MESTRE DE EMBREAGEM 19,05mm	VOLKSWAGEN - CAMINHÕES	11-140		1982/1993	
C-2608	CILINDRO MESTRE DE EMBREAGEM 19,05mm	VOLKSWAGEN - CAMINHÕES	11-160		1986/1993	
C-2608	CILINDRO MESTRE DE EMBREAGEM 19,05mm	VOLKSWAGEN - CAMINHÕES	12-140		1982/2000	
C-2608	CILINDRO MESTRE DE EMBREAGEM 19,05mm	VOLKSWAGEN - CAMINHÕES	13-130		1981/1986	

Polgadas	9/16"	5/8"	11/16"	7/10"	3/4"	13/16"	7/8"	15/16"	1"	1 1/16"	1 1/8"	1 1/4"	1 3/8"	1 1/2"	1 5/8"	1 3/4"	1 7/8"	2"
Milímetros	14,28mm	15,87mm	17,46mm	17,78mm	19,05mm	20,63mm	22,22mm	23,81mm	25,40mm	26,98mm	28,57mm	31,75mm	34,92mm	38,10mm	41,27mm	44,45mm	46,83mm	50,80mm

PEÇA	DESCRIÇÃO	MARCA	VEÍCULO		ANOS	SOMENTE PARA
C-2608	CILINDRO MESTRE DE EMBREAGEM 19,05mm	VOLKSWAGEN - CAMINHÕES	14-140		1982/1991	
C-2608	CILINDRO MESTRE DE EMBREAGEM 19,05mm	VOLKSWAGEN - CAMINHÕES	22-160		1986/1989	
C-2609	CILINDRO MESTRE DE EMBREAGEM 22,22mm	TOYOTA	BANDEIRANTE		1980/1986	
C-2610	CILINDRO AUXILIAR DE EMBREAGEM 28,57mm	MERCEDES BENZ - CAMINHÕES	L/LO-608 D/E		1976/1986	
C-2610	CILINDRO AUXILIAR DE EMBREAGEM 28,57mm	MERCEDES BENZ - CAMINHÕES	L/LO-708 D/E		1987/1988	
C-2611	CILINDRO AUXILIAR DE EMBREAGEM 28,57mm	MERCEDES BENZ - CAMINHÕES	L-709		1989/1996	
C-2611	CILINDRO AUXILIAR DE EMBREAGEM 28,57mm	MERCEDES BENZ - CAMINHÕES	L-710		1996/...	
C-2611	CILINDRO AUXILIAR DE EMBREAGEM 28,57mm	MERCEDES BENZ - CAMINHÕES	LO/OF-809		1989/...	
C-2611	CILINDRO AUXILIAR DE EMBREAGEM 28,57mm	MERCEDES BENZ - CAMINHÕES	L/LO/OF-812		1989/...	
C-2611	CILINDRO AUXILIAR DE EMBREAGEM 28,57mm	MERCEDES BENZ - CAMINHÕES	L/LO-912		1989/...	
C-2611	CILINDRO AUXILIAR DE EMBREAGEM 28,57mm	MERCEDES BENZ - CAMINHÕES	OF-1620		1992/...	
C-2611	CILINDRO AUXILIAR DE EMBREAGEM 28,57mm	MERCEDES BENZ - CAMINHÕES	LS-1630/1635		1991/...	
C-2611	CILINDRO AUXILIAR DE EMBREAGEM 28,57mm	MERCEDES BENZ - CAMINHÕES	LS-1938		1991/...	
C-2611	CILINDRO AUXILIAR DE EMBREAGEM 28,57mm	MERCEDES BENZ - CAMINHÕES	L/LS/LK-1941		1991/1991	MOD. L/LS
C-2612	CILINDRO AUXILIAR DE EMBREAGEM 22,22mm	VOLKSWAGEN - CAMINHÕES	Jun-80		1982/1986	
C-2612	CILINDRO AUXILIAR DE EMBREAGEM 22,22mm	VOLKSWAGEN - CAMINHÕES	Jun-90		1982/1986	
C-2612	CILINDRO AUXILIAR DE EMBREAGEM 22,22mm	VOLKSWAGEN - CAMINHÕES	Jul-90		1987/1994	
C-2612	CILINDRO AUXILIAR DE EMBREAGEM 22,22mm	VOLKSWAGEN - CAMINHÕES	7-110 S		1988/1994	
C-2612	CILINDRO AUXILIAR DE EMBREAGEM 22,22mm	VOLKSWAGEN - CAMINHÕES	11-130		1982/1985	
C-2612	CILINDRO AUXILIAR DE EMBREAGEM 22,22mm	VOLKSWAGEN - CAMINHÕES	11-140		1982/1993	
C-2612	CILINDRO AUXILIAR DE EMBREAGEM 22,22mm	VOLKSWAGEN - CAMINHÕES	11-160		1986/1993	
C-2612	CILINDRO AUXILIAR DE EMBREAGEM 22,22mm	VOLKSWAGEN - CAMINHÕES	12-140		1982/2000	
C-2612	CILINDRO AUXILIAR DE EMBREAGEM 22,22mm	VOLKSWAGEN - CAMINHÕES	13-130		1981/1986	
C-2612	CILINDRO AUXILIAR DE EMBREAGEM 22,22mm	VOLKSWAGEN - CAMINHÕES	14-140		1982/1991	
C-2612	CILINDRO AUXILIAR DE EMBREAGEM 22,22mm	VOLKSWAGEN - CAMINHÕES	22-160		1986/1989	
C-2613	CILINDRO AUXILIAR DE EMBREAGEM 22,22mm	AGRALE	4500/5000		1994/1998	
C-2613	CILINDRO AUXILIAR DE EMBREAGEM 22,22mm	AGRALE	6000		1999/...	
C-2613	CILINDRO AUXILIAR DE EMBREAGEM 22,22mm	AGRALE	7000/7500		1993/2005	
C-2613	CILINDRO AUXILIAR DE EMBREAGEM 22,22mm	AGRALE	8500		1997/...	
C-2613	CILINDRO AUXILIAR DE EMBREAGEM 22,22mm	AGRALE	9200 TCA		2003/...	
C-2613	CILINDRO AUXILIAR DE EMBREAGEM 22,22mm	AGRALE	FURGOVAN		2002/...	
C-2613	CILINDRO AUXILIAR DE EMBREAGEM 22,22mm	AGRALE	MA 5.0/6.0/7.5/8.0/8.5/9.2		1996/...	
C-2613	CILINDRO AUXILIAR DE EMBREAGEM 22,22mm	AGRALE	VOLARE A5/V5		2002/2007	
C-2613	CILINDRO AUXILIAR DE EMBREAGEM 22,22mm	AGRALE	VOLARE A6/V6		1998/2007	
C-2613	CILINDRO AUXILIAR DE EMBREAGEM 22,22mm	AGRALE	VOLARE A8/V8		2000/2004	
C-2613	CILINDRO AUXILIAR DE EMBREAGEM 22,22mm	AGRALE	VOLARE W8		2002/2007	
C-2613	CILINDRO AUXILIAR DE EMBREAGEM 22,22mm	AGRALE	VOLARE W9		2006/2007	
C-2613	CILINDRO AUXILIAR DE EMBREAGEM 22,22mm	FORD	F-1000		1996/1998	MOTOR MWM 4.3 DIESEL
C-2613	CILINDRO AUXILIAR DE EMBREAGEM 22,22mm	FORD - CAMINHÕES	B-1618/1621		1993/1996	
C-2613	CILINDRO AUXILIAR DE EMBREAGEM 22,22mm	FORD - CAMINHÕES	CARGO		1985/...	
C-2613	CILINDRO AUXILIAR DE EMBREAGEM 22,22mm	FORD - CAMINHÕES	F-4000		1995/1998	MOTOR MWM 4.3 TURBO
C-2613	CILINDRO AUXILIAR DE EMBREAGEM 22,22mm	FORD - CAMINHÕES	F-12000		1996/1998	
C-2613	CILINDRO AUXILIAR DE EMBREAGEM 22,22mm	FORD - CAMINHÕES	F-14000		1996/1998	
C-2613	CILINDRO AUXILIAR DE EMBREAGEM 22,22mm	VOLKSWAGEN - CAMINHÕES	7-100		1994/2001	
C-2613	CILINDRO AUXILIAR DE EMBREAGEM 22,22mm	VOLKSWAGEN - CAMINHÕES	7-110		2002/2005	
C-2613	CILINDRO AUXILIAR DE EMBREAGEM 22,22mm	VOLKSWAGEN - CAMINHÕES	8-100		1997/2000	
C-2613	CILINDRO AUXILIAR DE EMBREAGEM 22,22mm	VOLKSWAGEN - CAMINHÕES	8-120		2000/...	
C-2613	CILINDRO AUXILIAR DE EMBREAGEM 22,22mm	VOLKSWAGEN - CAMINHÕES	8-140 CE/CO		1994/2000	
C-2613	CILINDRO AUXILIAR DE EMBREAGEM 22,22mm	VOLKSWAGEN - CAMINHÕES	8-150		2000/...	
C-2613	CILINDRO AUXILIAR DE EMBREAGEM 22,22mm	VOLKSWAGEN - CAMINHÕES	9-150 OD		2001/...	
C-2613	CILINDRO AUXILIAR DE EMBREAGEM 22,22mm	VOLKSWAGEN - CAMINHÕES	12-140H		1994/1998	
C-2613	CILINDRO AUXILIAR DE EMBREAGEM 22,22mm	VOLKSWAGEN - CAMINHÕES	14-150		1991/2000	C/ CÂMBIO SINCRONIZADO
C-2613	CILINDRO AUXILIAR DE EMBREAGEM 22,22mm	VOLKSWAGEN - CAMINHÕES	14-200		1991/1994	
C-2613	CILINDRO AUXILIAR DE EMBREAGEM 22,22mm	VOLKSWAGEN - CAMINHÕES	14-220		1992/2000	
C-2613	CILINDRO AUXILIAR DE EMBREAGEM 22,22mm	VOLKSWAGEN - CAMINHÕES	16-170		1991/1999	
C-2613	CILINDRO AUXILIAR DE EMBREAGEM 22,22mm	VOLKSWAGEN - CAMINHÕES	16-220		1991/2000	
C-2613	CILINDRO AUXILIAR DE EMBREAGEM 22,22mm	VOLKSWAGEN - CAMINHÕES	24-220		1991/...	
C-2613	CILINDRO AUXILIAR DE EMBREAGEM 22,22mm	VOLKSWAGEN - CAMINHÕES	24-250		1992/...	S/ SERVO EMBREAGEM
C-2613	CILINDRO AUXILIAR DE EMBREAGEM 22,22mm	VOLKSWAGEN - CAMINHÕES	35-300		1991/1999	
C-2613	CILINDRO AUXILIAR DE EMBREAGEM 22,22mm	VOLKSWAGEN - CAMINHÕES	40-300		1999/2001	
C-2614	CILINDRO AUXILIAR DE EMBREAGEM 38,10mm	MERCEDES BENZ - CAMINHÕES	0-370		1984/...	
C-2614	CILINDRO AUXILIAR DE EMBREAGEM 38,10mm	MERCEDES BENZ - CAMINHÕES	0-371		1984/...	

Tabela de Conversão	Polegadas	9/16"	5/8"	11/16"	7/10"	3/4"	13/16"	7/8"	15/16"	1"	1 1/16"	1 1/8"	1 1/4"	1 3/8"	1 1/2"	1 5/8"	1 3/4"	1 27/32"	2"
	Milímetros	14,28mm	15,87mm	17,46mm	17,78mm	19,05mm	20,63mm	22,22mm	23,81mm	25,40mm	26,98mm	28,57mm	31,75mm	34,92mm	38,10mm	41,27mm	44,45mm	46,83mm	50,80mm

PEÇA	DESCRIÇÃO	MARCA	VEÍCULO		ANOS	SOMENTE PARA
C-2614	CILINDRO AUXILIAR DE EMBREAGEM 38,10mm	MERCEDES BENZ - CAMINHÕES	L/LK/LP-1214		1989/...	
C-2614	CILINDRO AUXILIAR DE EMBREAGEM 38,10mm	MERCEDES BENZ - CAMINHÕES	L/OH-1316		1970/1989	
C-2614	CILINDRO AUXILIAR DE EMBREAGEM 38,10mm	MERCEDES BENZ - CAMINHÕES	OH-1317		1970/1989	
C-2614	CILINDRO AUXILIAR DE EMBREAGEM 38,10mm	MERCEDES BENZ - CAMINHÕES	OF/OH-1318		1987/...	
C-2614	CILINDRO AUXILIAR DE EMBREAGEM 38,10mm	MERCEDES BENZ - CAMINHÕES	L/LP/OH-1419		1980/...	
C-2614	CILINDRO AUXILIAR DE EMBREAGEM 38,10mm	MERCEDES BENZ - CAMINHÕES	OH-1420		1980/...	
C-2614	CILINDRO AUXILIAR DE EMBREAGEM 38,10mm	MERCEDES BENZ - CAMINHÕES	L/LP-1614		1989/...	
C-2614	CILINDRO AUXILIAR DE EMBREAGEM 38,10mm	MERCEDES BENZ - CAMINHÕES	L/LK-1618		1989/...	
C-2614	CILINDRO AUXILIAR DE EMBREAGEM 38,10mm	MERCEDES BENZ - CAMINHÕES	L/LS-1625		1991/...	
C-2614	CILINDRO AUXILIAR DE EMBREAGEM 38,10mm	MERCEDES BENZ - CAMINHÕES	L-1714		1991/...	
C-2615	CILINDRO AUXILIAR DE EMBREAGEM 38,10mm	MERCEDES BENZ - CAMINHÕES	L/LK/LS-1621		1989/...	
C-2616	CILINDRO AUXILIAR DE EMBREAGEM 22,22mm	VOLKSWAGEN - CAMINHÕES	13-210		1987/1991	
C-2616	CILINDRO AUXILIAR DE EMBREAGEM 22,22mm	VOLKSWAGEN - CAMINHÕES	14-210		1987/1991	
C-2616	CILINDRO AUXILIAR DE EMBREAGEM 22,22mm	VOLKSWAGEN - CAMINHÕES	16-210		1989/1991	
C-2617	CILINDRO AUXILIAR DE EMBREAGEM 22,22mm	TOYOTA	BANDEIRANTE		1966/1994	
C-2617	CILINDRO AUXILIAR DE EMBREAGEM 22,22mm	TROLLER	T4		2002/...	
C-2618	CILINDRO MESTRE DE EMBREAGEM 25,40mm	TOYOTA	BANDEIRANTE		1966/1978	
C-2619	CILINDRO MESTRE DE EMBREAGEM 22,22mm	TOYOTA	BANDEIRANTE		1979/1980	
C-2620	CILINDRO MESTRE DE EMBREAGEM 25,40mm	SCANIA - CAMINHÕES	F/K/S-112		1983/1990	
C-2620	CILINDRO MESTRE DE EMBREAGEM 25,40mm	SCANIA - CAMINHÕES	R/T-112		1981/1991	
C-2620	CILINDRO MESTRE DE EMBREAGEM 25,40mm	SCANIA - CAMINHÕES	R/T-142		1981/1991	
C-2621	CILINDRO MESTRE DE EMBREAGEM 20,63mm	AGRALE	MA 12.0		2004/...	
C-2621	CILINDRO MESTRE DE EMBREAGEM 20,63mm	MERCEDES BENZ - CAMINHÕES	L/LS/LK-1929		1992/...	
C-2621	CILINDRO MESTRE DE EMBREAGEM 20,63mm	MERCEDES BENZ - CAMINHÕES	L/LS/LK-1935		1992/...	
C-2621	CILINDRO MESTRE DE EMBREAGEM 20,63mm	MERCEDES BENZ - CAMINHÕES	L/LS/LK-1941		1992/...	
C-2622	CILINDRO MESTRE DE EMBREAGEM 20,63mm	MERCEDES BENZ - CAMINHÕES	O-400 R/RS/RSD/RSL/UP		1992/...	
C-2623	CILINDRO MESTRE DE EMBREAGEM 26,00mm	SCANIA - CAMINHÕES	R/T-113		1991/1998	
C-2623	CILINDRO MESTRE DE EMBREAGEM 26,00mm	SCANIA - CAMINHÕES	R/T-143		1991/1995	
C-2624	CILINDRO MESTRE DE EMBREAGEM 19,05mm	GM - CHEVROLET	BLAZER		1996/2000	MOTOR 2.2 GASOLINA/2.5 DIESEL
C-2624	CILINDRO MESTRE DE EMBREAGEM 19,05mm	GM - CHEVROLET	BLAZER		2001/2011	MOTOR 2.4 GASOLINA
C-2624	CILINDRO MESTRE DE EMBREAGEM 19,05mm	GM - CHEVROLET	S-10		1995/2000	MOTOR 2.2 GASOLINA/2.5 DIESEL
C-2624	CILINDRO MESTRE DE EMBREAGEM 19,05mm	GM - CHEVROLET	S-10		2001/2012	MOTOR 2.4 GASOLINA
C-2625	CILINDRO AUXILIAR DE EMBREAGEM 20,63mm	GM - CHEVROLET	BLAZER		1996/2000	MOTOR 2.2 GASOLINA/2.5 DIESEL
C-2625	CILINDRO AUXILIAR DE EMBREAGEM 20,63mm	GM - CHEVROLET	BLAZER		2001/2011	MOTOR 2.4 GASOLINA
C-2625	CILINDRO AUXILIAR DE EMBREAGEM 20,63mm	GM - CHEVROLET	S-10		1995/2000	MOTOR 2.2 GASOLINA/2.5 DIESEL
C-2625	CILINDRO AUXILIAR DE EMBREAGEM 20,63mm	GM - CHEVROLET	S-10		2001/2012	MOTOR 2.4 GASOLINA
C-2626	CILINDRO MESTRE DE EMBREAGEM 22,22mm	GM - CHEVROLET	A-20		1993/1996	
C-2626	CILINDRO MESTRE DE EMBREAGEM 22,22mm	GM - CHEVROLET	BONANZA		1993/1996	
C-2626	CILINDRO MESTRE DE EMBREAGEM 22,22mm	GM - CHEVROLET	C-20		1993/1996	
C-2626	CILINDRO MESTRE DE EMBREAGEM 22,22mm	GM - CHEVROLET	D-20		1993/1996	
C-2626	CILINDRO MESTRE DE EMBREAGEM 22,22mm	GM - CHEVROLET	VERANEIO		1993/1996	
C-2626	CILINDRO MESTRE DE EMBREAGEM 22,22mm	GM - CAMINHÕES	D-40		1993/1997	
C-2627	CILINDRO AUXILIAR DE EMBREAGEM 20,63mm	GM - CHEVROLET	A-20		1993/1996	
C-2627	CILINDRO AUXILIAR DE EMBREAGEM 20,63mm	GM - CHEVROLET	BONANZA		1993/1996	
C-2627	CILINDRO AUXILIAR DE EMBREAGEM 20,63mm	GM - CHEVROLET	C-20		1993/1996	
C-2627	CILINDRO AUXILIAR DE EMBREAGEM 20,63mm	GM - CHEVROLET	D-20		1993/1996	
C-2627	CILINDRO AUXILIAR DE EMBREAGEM 20,63mm	GM - CHEVROLET	GRAND BLAZER		1998/2000	
C-2627	CILINDRO AUXILIAR DE EMBREAGEM 20,63mm	GM - CHEVROLET	SILVERADO		1997/2001	
C-2627	CILINDRO AUXILIAR DE EMBREAGEM 20,63mm	GM - CHEVROLET	VERANEIO		1993/1996	
C-2627	CILINDRO AUXILIAR DE EMBREAGEM 20,63mm	GM - CAMINHÕES	D-40		1993/1997	
C-2627	CILINDRO AUXILIAR DE EMBREAGEM 20,63mm	GMC	3500 HD		1997/2002	
C-2627	CILINDRO AUXILIAR DE EMBREAGEM 20,63mm	GMC	6-100		1998/2002	
C-2627	CILINDRO AUXILIAR DE EMBREAGEM 20,63mm	GMC	6-150		1998/2002	
C-2628	CILINDRO MESTRE DE EMBREAGEM 22,22mm	FORD	F-1000		1996/1998	MOTOR MWM 4.3 DIESEL
C-2628	CILINDRO MESTRE DE EMBREAGEM 22,22mm	FORD - CAMINHÕES	F-4000		1995/1998	MOTOR MWM 4.3 TURBO
C-2629	CILINDRO MESTRE DE EMBREAGEM 19,05mm	FORD	F-1000		1995/1998	MOTOR 4.9 GASOLINA/2.5 HSD DIESEL
C-2630	CILINDRO MESTRE DE EMBREAGEM 19,05mm	MERCEDES BENZ	SPRINTER		1997/...	
C-2631	CILINDRO AUXILIAR DE EMBREAGEM 22,22mm	MERCEDES BENZ	SPRINTER		1997/2002	MOD. 310/312/412
C-2632	CILINDRO MESTRE DE EMBREAGEM 19,05mm	MERCEDES BENZ	MB-180		1994/1996	
C-2633	CILINDRO AUXILIAR DE EMBREAGEM 25,40mm	MERCEDES BENZ	MB-180		1994/1996	
C-2634	CILINDRO MESTRE DE EMBREAGEM 15,87mm	ASIA	TOPIC		1993/1999	
C-2634	CILINDRO MESTRE DE EMBREAGEM 15,87mm	KIA	BESTA		1993/2005	

Tabela de Conversão	Polegadas	9/16"	5/8"	11/16"	7/10"	3/4"	13/16"	7/8"	15/16"	1"	1 1/16"	1 1/8"	1 1/4"	1 3/8"	1 1/2"	1 5/8"	1 3/4"	1 27/32"	2"
	Milímetros		14,28mm	15,87mm	17,46mm	17,78mm	19,05mm	20,63mm	22,22mm	23,81mm	25,40mm	26,98mm	28,57mm	31,75mm	34,92mm	38,10mm	41,27mm	44,45mm	46,83mm



PEÇA	DESCRIÇÃO	MARCA	VEÍCULO		ANOS	SOMENTE PARA
C-2634	CILINDRO MESTRE DE EMBREAGEM 15,87mm	KIA	BONGO		1993/2004	K-2400/2700
C-2635	CILINDRO AUXILIAR DE EMBREAGEM 19,05mm	KIA	BESTA		1993/2005	
C-2635	CILINDRO AUXILIAR DE EMBREAGEM 19,05mm	KIA	BONGO		1993/2004	K-2400/2700
C-2636	CILINDRO AUXILIAR DE EMBREAGEM 19,05mm	ASIA	TOPIC		1993/1999	
C-2637	CILINDRO MESTRE DE EMBREAGEM 28,57mm	VOLVO - CAMINHÕES	B-10 M		1986/...	
C-2637	CILINDRO MESTRE DE EMBREAGEM 28,57mm	VOLVO - CAMINHÕES	B-12		1992/...	
C-2637	CILINDRO MESTRE DE EMBREAGEM 28,57mm	VOLVO - CAMINHÕES	B-58		1979/...	
C-2637	CILINDRO MESTRE DE EMBREAGEM 28,57mm	VOLVO - CAMINHÕES	N/NL-10		1980/...	
C-2637	CILINDRO MESTRE DE EMBREAGEM 28,57mm	VOLVO - CAMINHÕES	N/NL-12		1981/...	
C-2638	CILINDRO MESTRE DE EMBREAGEM 19,05mm	GM - CHEVROLET	GRAND BLAZER		1998/2000	
C-2638	CILINDRO MESTRE DE EMBREAGEM 19,05mm	GM - CHEVROLET	SILVERADO		1997/2001	
C-2638	CILINDRO MESTRE DE EMBREAGEM 19,05mm	GMC	3500 HD		1997/2002	
C-2638	CILINDRO MESTRE DE EMBREAGEM 19,05mm	GMC	6-100		1998/2002	
C-2638	CILINDRO MESTRE DE EMBREAGEM 19,05mm	GMC	6-150		1998/2002	
C-2639	CILINDRO MESTRE DE EMBREAGEM 23,81mm	AGRALE	FURGOVAN		2004/...	MOTOR ELETRÔNICO
C-2639	CILINDRO MESTRE DE EMBREAGEM 23,81mm	AGRALE	MA 5.0/6.0/7.5/8.0/8.5/9.2		2004/...	MOTOR ELETRÔNICO
C-2639	CILINDRO MESTRE DE EMBREAGEM 23,81mm	AGRALE	VOLARE A5/V5		2005/2007	
C-2639	CILINDRO MESTRE DE EMBREAGEM 23,81mm	AGRALE	VOLARE A6/V6		2005/2007	
C-2639	CILINDRO MESTRE DE EMBREAGEM 23,81mm	AGRALE	VOLARE A8/V8		2005/2007	
C-2639	CILINDRO MESTRE DE EMBREAGEM 23,81mm	AGRALE	VOLARE W8		2005/2007	
C-2639	CILINDRO MESTRE DE EMBREAGEM 23,81mm	AGRALE	VOLARE W9		2006/2007	
C-2641	CILINDRO MESTRE DE EMBREAGEM 19,05mm	FORD	COURIER		1998/1998	
C-2641	CILINDRO MESTRE DE EMBREAGEM 19,05mm	FORD	FIESTA		1996/1998	
C-2642	CILINDRO MESTRE DE EMBREAGEM 15,87mm	GM - CHEVROLET	VECTRA		1997/2005	
C-2643	CILINDRO MESTRE DE EMBREAGEM 19,05mm	FORD	COURIER		1999/...	
C-2643	CILINDRO MESTRE DE EMBREAGEM 19,05mm	FORD	ESCORT		2001/2003	MOTOR 1.6 8V
C-2643	CILINDRO MESTRE DE EMBREAGEM 19,05mm	FORD	ESCORT SW		2001/2003	MOTOR 1.6 8V
C-2643	CILINDRO MESTRE DE EMBREAGEM 19,05mm	FORD	FIESTA		1999/2002	
C-2643	CILINDRO MESTRE DE EMBREAGEM 19,05mm	FORD	FIESTA STREET HATCH		2001/2007	
C-2643	CILINDRO MESTRE DE EMBREAGEM 19,05mm	FORD	FIESTA STREET SEDAN		2002/2004	
C-2643	CILINDRO MESTRE DE EMBREAGEM 19,05mm	FORD	KA		1999/...	
C-2644	CILINDRO MESTRE DE EMBREAGEM 15,87mm	GM - CHEVROLET	ASTRA		1999/2011	
C-2644	CILINDRO MESTRE DE EMBREAGEM 15,87mm	GM - CHEVROLET	VECTRA		2006/2011	
C-2645	CILINDRO MESTRE DE EMBREAGEM 19,05mm	FORD	KA		1997/1998	
C-2646	CILINDRO MESTRE DE EMBREAGEM 19,05mm	GM - CHEVROLET	BLAZER		1996/2000	MOTOR 4.3 V6
C-2646	CILINDRO MESTRE DE EMBREAGEM 19,05mm	GM - CHEVROLET	BLAZER		2001/2011	MOTOR 4.3 V6/2.8 DIESEL
C-2646	CILINDRO MESTRE DE EMBREAGEM 19,05mm	GM - CHEVROLET	S-10		1995/2000	MOTOR 4.3 V6
C-2646	CILINDRO MESTRE DE EMBREAGEM 19,05mm	GM - CHEVROLET	S-10		2001/2012	MOTOR 4.3 V6/2.8 DIESEL
C-2647	CILINDRO MESTRE DE EMBREAGEM 15,87mm	FIAT	IDEA		2006/...	
C-2647	CILINDRO MESTRE DE EMBREAGEM 15,87mm	FIAT	PALIO		2001/...	MOTOR 1.0/1.3/1.4/1.6
C-2647	CILINDRO MESTRE DE EMBREAGEM 15,87mm	FIAT	PALIO		2006/...	MOTOR 1.8 SIST. LUK
C-2647	CILINDRO MESTRE DE EMBREAGEM 15,87mm	FIAT	PALIO WEEKEND		2001/...	MOTOR 1.0/1.3/1.4/1.6
C-2647	CILINDRO MESTRE DE EMBREAGEM 15,87mm	FIAT	PALIO WEEKEND		2005/...	MOTOR 1.8 SIST. LUK
C-2647	CILINDRO MESTRE DE EMBREAGEM 15,87mm	FIAT	SIENA		2001/...	MOTOR 1.0/1.3/1.4/1.6
C-2647	CILINDRO MESTRE DE EMBREAGEM 15,87mm	FIAT	SIENA		2006/...	MOTOR 1.8 SIST. LUK
C-2647	CILINDRO MESTRE DE EMBREAGEM 15,87mm	FIAT	STRADA		2001/...	MOTOR 1.3/1.4/1.6
C-2647	CILINDRO MESTRE DE EMBREAGEM 15,87mm	FIAT	STRADA		2005/...	MOTOR 1.8 SIST. LUK
C-2648	CILINDRO AUXILIAR DE EMBREAGEM 22,22mm	FIAT	IDEA		2006/...	MOTOR 1.4
C-2648	CILINDRO AUXILIAR DE EMBREAGEM 22,22mm	FIAT	PALIO		2001/...	MOTOR 1.0/1.3/1.4/1.6
C-2648	CILINDRO AUXILIAR DE EMBREAGEM 22,22mm	FIAT	PALIO WEEKEND		2001/...	MOTOR 1.0/1.3/1.4/1.6
C-2648	CILINDRO AUXILIAR DE EMBREAGEM 22,22mm	FIAT	PUNTO		2008/...	MOTOR 1.4
C-2648	CILINDRO AUXILIAR DE EMBREAGEM 22,22mm	FIAT	SIENA		2001/...	MOTOR 1.0/1.3/1.4/1.6
C-2648	CILINDRO AUXILIAR DE EMBREAGEM 22,22mm	FIAT	STRADA		2001/...	MOTOR 1.3/1.4/1.6
C-2649	CILINDRO MESTRE DE EMBREAGEM 15,87mm	FORD	RANGER		1995/2012	
C-2650	CILINDRO MESTRE DE EMBREAGEM 15,87mm	AUDI	A3		1997/2006	
C-2650	CILINDRO MESTRE DE EMBREAGEM 15,87mm	AUDI	TT		1999/2006	
C-2650	CILINDRO MESTRE DE EMBREAGEM 15,87mm	VOLKSWAGEN	BORA		2001/2011	
C-2650	CILINDRO MESTRE DE EMBREAGEM 15,87mm	VOLKSWAGEN	GOLF		1999/...	
C-2650	CILINDRO MESTRE DE EMBREAGEM 15,87mm	VOLKSWAGEN	NEW BEETLE		2000/2010	
C-2651	CILINDRO AUXILIAR DE EMBREAGEM 19,05mm	AUDI	A3		2003/2006	MOTOR 1.6 101 CV
C-2651	CILINDRO AUXILIAR DE EMBREAGEM 19,05mm	AUDI	A3		2007/2010	MOTOR 1.6 102 CV
C-2651	CILINDRO AUXILIAR DE EMBREAGEM 19,05mm	AUDI	A3 SPORTBACK		2007/2010	MOTOR 1.6 102 CV

Tabela de Conversão	Polegadas	9/16"	5/8"	11/16"	7/10"	3/4"	13/16"	7/8"	15/16"	1"	1 1/16"	1 1/8"	1 1/4"	1 3/8"	1 1/2"	1 5/8"	1 3/4"	1 27/32"	2"
	Milímetros	14,28mm	15,87mm	17,46mm	17,78mm	19,05mm	20,63mm	22,22mm	23,81mm	25,40mm	26,98mm	28,57mm	31,75mm	34,92mm	38,10mm	41,27mm	44,45mm	46,83mm	50,80mm

PEÇA	DESCRIÇÃO	MARCA	VEÍCULO		ANOS	SOMENTE PARA
C-2651	CILINDRO AUXILIAR DE EMBREAGEM 19,05mm	VOLKSWAGEN	CROSSFOX		2005/...	
C-2651	CILINDRO AUXILIAR DE EMBREAGEM 19,05mm	VOLKSWAGEN	FOX		2004/...	
C-2651	CILINDRO AUXILIAR DE EMBREAGEM 19,05mm	VOLKSWAGEN	GOL (G5)		2009/...	
C-2651	CILINDRO AUXILIAR DE EMBREAGEM 19,05mm	VOLKSWAGEN	GOLF		2001/...	MOTOR 1.6 101 CV
C-2651	CILINDRO AUXILIAR DE EMBREAGEM 19,05mm	VOLKSWAGEN	POLO		2002/...	
C-2651	CILINDRO AUXILIAR DE EMBREAGEM 19,05mm	VOLKSWAGEN	SAVEIRO (G5)		2010/...	
C-2651	CILINDRO AUXILIAR DE EMBREAGEM 19,05mm	VOLKSWAGEN	SPACEFOX		2006/...	
C-2651	CILINDRO AUXILIAR DE EMBREAGEM 19,05mm	VOLKSWAGEN	SPACE CROSS		2012/...	
C-2651	CILINDRO AUXILIAR DE EMBREAGEM 19,05mm	VOLKSWAGEN	VOYAGE (G5)		2009/...	
C-2652	CILINDRO MESTRE DE EMBREAGEM 15,87mm	MITSUBISHI	L200		2003/2012	HPE/SPORT/OUTDOOR
C-2653	CILINDRO AUXILIAR DE EMBREAGEM 25,40mm	AGRALE	VOLARE A5/V5		2008/...	
C-2653	CILINDRO AUXILIAR DE EMBREAGEM 25,40mm	AGRALE	VOLARE A6/V6		2008/...	
C-2653	CILINDRO AUXILIAR DE EMBREAGEM 25,40mm	AGRALE	VOLARE A8/V8		2008/...	
C-2653	CILINDRO AUXILIAR DE EMBREAGEM 25,40mm	AGRALE	VOLARE W8		2008/...	
C-2653	CILINDRO AUXILIAR DE EMBREAGEM 25,40mm	AGRALE	VOLARE W9		2008/...	
C-2655	CILINDRO MESTRE DE EMBREAGEM 20,63mm	MERCEDES BENZ - CAMINHÕES	ACCELO 915 C		2004/...	
C-2655	CILINDRO MESTRE DE EMBREAGEM 20,63mm	MERCEDES BENZ - CAMINHÕES	L-1215		2000/...	
C-2655	CILINDRO MESTRE DE EMBREAGEM 20,63mm	MERCEDES BENZ - CAMINHÕES	OF-1721		2000/...	
C-2655	CILINDRO MESTRE DE EMBREAGEM 20,63mm	MERCEDES BENZ - CAMINHÕES	C-2423 B/K		2000/...	
C-2656	CILINDRO AUXILIAR DE EMBREAGEM 19,05mm	AUDI	A3		1997/2002	
C-2656	CILINDRO AUXILIAR DE EMBREAGEM 19,05mm	AUDI	A3		2003/2006	MOTOR 1.8
C-2656	CILINDRO AUXILIAR DE EMBREAGEM 19,05mm	AUDI	TT		1999/2006	
C-2656	CILINDRO AUXILIAR DE EMBREAGEM 19,05mm	SEAT	INCA		2001/2002	
C-2656	CILINDRO AUXILIAR DE EMBREAGEM 19,05mm	VOLKSWAGEN	BORA		2001/2011	
C-2656	CILINDRO AUXILIAR DE EMBREAGEM 19,05mm	VOLKSWAGEN	CARAVELLE		1998/1999	
C-2656	CILINDRO AUXILIAR DE EMBREAGEM 19,05mm	VOLKSWAGEN	EUROVAN		1998/1999	
C-2656	CILINDRO AUXILIAR DE EMBREAGEM 19,05mm	VOLKSWAGEN	GOLF		1999/2000	ACION. P/ CABOS
C-2656	CILINDRO AUXILIAR DE EMBREAGEM 19,05mm	VOLKSWAGEN	GOLF		2001/...	MOTOR 1.8/2.0
C-2656	CILINDRO AUXILIAR DE EMBREAGEM 19,05mm	VOLKSWAGEN	NEW BEETLE		2000/2010	
C-2656	CILINDRO AUXILIAR DE EMBREAGEM 19,05mm	VOLKSWAGEN	POLO CLASSIC		2001/2002	
C-2656	CILINDRO AUXILIAR DE EMBREAGEM 19,05mm	VOLKSWAGEN	VAN		2001/2002	
C-2657	CILINDRO MESTRE DE EMBREAGEM 15,87mm	VOLKSWAGEN	CROSSFOX		2005/...	
C-2657	CILINDRO MESTRE DE EMBREAGEM 15,87mm	VOLKSWAGEN	FOX		2004/...	
C-2657	CILINDRO MESTRE DE EMBREAGEM 15,87mm	VOLKSWAGEN	GOL (G5)		2009/...	
C-2657	CILINDRO MESTRE DE EMBREAGEM 15,87mm	VOLKSWAGEN	POLO		2002/...	
C-2657	CILINDRO MESTRE DE EMBREAGEM 15,87mm	VOLKSWAGEN	SAVEIRO (G5)		2010/...	
C-2657	CILINDRO MESTRE DE EMBREAGEM 15,87mm	VOLKSWAGEN	SPACEFOX		2006/...	
C-2657	CILINDRO MESTRE DE EMBREAGEM 15,87mm	VOLKSWAGEN	SPACE CROSS		2012/...	
C-2657	CILINDRO MESTRE DE EMBREAGEM 15,87mm	VOLKSWAGEN	VOYAGE (G5)		2009/...	
C-2658	CILINDRO MESTRE DE EMBREAGEM 18,20mm	FORD - CAMINHÕES	F-12000		1999/2005	
C-2658	CILINDRO MESTRE DE EMBREAGEM 18,20mm	FORD - CAMINHÕES	F-14000		1999/2005	
C-2658	CILINDRO MESTRE DE EMBREAGEM 18,20mm	FORD - CAMINHÕES	F-16000		1999/2004	
C-2660	CILINDRO AUXILIAR DE EMBREAGEM 20,63mm	DODGE	DAKOTA		1998/2001	
C-2661	CILINDRO MESTRE DE EMBREAGEM 19,05mm	FORD	ECOSPORT		2003/2012	
C-2661	CILINDRO MESTRE DE EMBREAGEM 19,05mm	FORD	FIESTA		2003/...	
C-2661	CILINDRO MESTRE DE EMBREAGEM 19,05mm	FORD	FIESTA SEDAN		2005/...	
C-2662	CILINDRO MESTRE DE EMBREAGEM 15,87mm	GM - CHEVROLET	CORSA		2002/2012	
C-2662	CILINDRO MESTRE DE EMBREAGEM 15,87mm	GM - CHEVROLET	MONTANA		2004/2010	
C-2664	CILINDRO AUXILIAR DE EMBREAGEM 19,05mm	MITSUBISHI	L200		1992/2006	L/GL/GLS
C-2665	CILINDRO MESTRE DE EMBREAGEM 28,57mm	VOLVO - CAMINHÕES	FH-12		1993/2006	
C-2665	CILINDRO MESTRE DE EMBREAGEM 28,57mm	VOLVO - CAMINHÕES	NH-12		1999/2006	
C-2667	CILINDRO MESTRE DE EMBREAGEM 15,87mm	GM - CHEVROLET	MERIVA		2003/2012	1.8 8V
C-2667	CILINDRO MESTRE DE EMBREAGEM 15,87mm	GM - CHEVROLET	MERIVA		TODOS	CÂMBIO F-17
C-2668	CILINDRO MESTRE DE EMBREAGEM 15,87mm	GM - CHEVROLET	ZAFIRA		2002/2012	
C-2670	CILINDRO MESTRE DE EMBREAGEM 23,81mm	AGRALE	VOLARE A5/V5		2008/...	
C-2670	CILINDRO MESTRE DE EMBREAGEM 23,81mm	AGRALE	VOLARE A6/V6		2008/...	
C-2670	CILINDRO MESTRE DE EMBREAGEM 23,81mm	AGRALE	VOLARE A8/V8		2008/...	
C-2670	CILINDRO MESTRE DE EMBREAGEM 23,81mm	AGRALE	VOLARE W8		2008/...	
C-2670	CILINDRO MESTRE DE EMBREAGEM 23,81mm	AGRALE	VOLARE W9		2008/...	
C-2671	CILINDRO MESTRE DE EMBREAGEM 15,87mm	TOYOTA	COROLLA		1993/2002	
C-2672	CILINDRO MESTRE DE EMBREAGEM 15,87mm	TOYOTA	HILUX SW4		1992/2005	
C-2673	CILINDRO MESTRE DE EMBREAGEM 15,87mm	TOYOTA	HILUX PICK-UP		2006/	

Tabela de Conversão	Polegadas	9/16"	5/8"	11/16"	7/10"	3/4"	13/16"	7/8"	15/16"	1"	1 1/16"	1 1/8"	1 1/4"	1 3/8"	1 1/2"	1 5/8"	1 3/4"	1 7/8"	2"
	Milímetros	14,28mm	15,87mm	17,46mm	17,78mm	19,05mm	20,63mm	22,22mm	23,81mm	25,40mm	26,98mm	28,57mm	31,75mm	34,92mm	38,10mm	41,27mm	44,45mm	46,83mm	50,80mm

PEÇA	DESCRIÇÃO	MARCA	VEÍCULO		ANOS	SOMENTE PARA
C-2673	CILINDRO MESTRE DE EMBREAGEM 15,87mm	TOYOTA	HILUX SW4		2006/	
C-2674	CILINDRO MESTRE DE EMBREAGEM 15,87mm	HONDA	CIVIC		1996/2000	
C-2675	CILINDRO MESTRE DE EMBREAGEM 19,05mm	MITSUBISHI	L200 TRITON		2007/2011	
C-2676	CILINDRO AUXILIAR DE EMBREAGEM 20,63mm	TOYOTA	HILUX PICK-UP		2001/2004	
C-2676	CILINDRO AUXILIAR DE EMBREAGEM 20,63mm	TOYOTA	HILUX SW4		1992/2001	
C-2677	CILINDRO AUXILIAR DE EMBREAGEM 19,05mm	HONDA	CIVIC		1992/2000	
C-2678	CILINDRO AUXILIAR DE EMBREAGEM 20,63mm	TOYOTA	COROLLA		1993/2002	
C-2681	CILINDRO MESTRE DE EMBREAGEM 15,87mm	CITROËN	AIRCROSS		2010/...	
C-2681	CILINDRO MESTRE DE EMBREAGEM 15,87mm	CITROËN	C3		2004/...	1.4 8V / 1.6 16V
C-2681	CILINDRO MESTRE DE EMBREAGEM 15,87mm	CITROËN	C3		2011/...	C3 PICASSO
C-2681	CILINDRO MESTRE DE EMBREAGEM 15,87mm	CITROËN	C3		2013/...	1.5/1.6 16V
C-2681	CILINDRO MESTRE DE EMBREAGEM 15,87mm	PEUGEOT	208		2012/...	1.5/1.6/1.6 THP
C-2682	CILINDRO AUXILIAR DE EMBREAGEM 19,05mm	CITROËN	C3		2004/...	1.4 8V / 1.6 16V
C-2682	CILINDRO AUXILIAR DE EMBREAGEM 19,05mm	PEUGEOT	208		2000/...	1.5/1.6/1.6 THP
C-2682	CILINDRO AUXILIAR DE EMBREAGEM 19,05mm	PEUGEOT	307		2000/...	1.6 16V
C-2683	CILINDRO MESTRE DE EMBREAGEM 25,40mm	SCANIA - CAMINHÕES	K113		TODOS	SÉRIE 3
C-2683	CILINDRO MESTRE DE EMBREAGEM 25,40mm	SCANIA - CAMINHÕES	L113		TODOS	SÉRIE 3
C-2684	CILINDRO MESTRE DE EMBREAGEM 19,05mm	FORD	FOCUS		.../2004	MOTOR 1.68VZETEC ROCAM
C-2684	CILINDRO MESTRE DE EMBREAGEM 19,05mm	FORD	FOCUS		2000/2007	MOTOR 1.8 E 2.016VZETEC
C-2685	CILINDRO MESTRE DE EMBREAGEM 15,87mm	CITROËN	C4		2003/...	2.0 16V
C-2685	CILINDRO MESTRE DE EMBREAGEM 15,87mm	PEUGEOT	307		2000/...	2.0 16V
C-2685	CILINDRO MESTRE DE EMBREAGEM 15,87mm	PEUGEOT	308		2000/...	1.6/2.0 16V
C-2685	CILINDRO MESTRE DE EMBREAGEM 15,87mm	PEUGEOT	408		2000/...	2.0 16V
C-2686	CILINDRO MESTRE DE EMBREAGEM 15,87mm	CITROËN	C4		2003/...	
C-2686	CILINDRO MESTRE DE EMBREAGEM 15,87mm	PEUGEOT	307		2000/...	1.6 16V
C-2687	CILINDRO AUXILIAR DE EMBREAGEM 19,05mm	CITROËN	C4		2003/...	2.0 16V
C-2687	CILINDRO AUXILIAR DE EMBREAGEM 19,05mm	CITROËN	XSARA PICASSO		2003/...	1.6/2.0 16V
C-2687	CILINDRO AUXILIAR DE EMBREAGEM 19,05mm	PEUGEOT	307		2000/...	2.0 16V
C-2687	CILINDRO AUXILIAR DE EMBREAGEM 19,05mm	PEUGEOT	308		2000/...	1.6 / 2.0 16V
C-2687	CILINDRO AUXILIAR DE EMBREAGEM 19,05mm	PEUGEOT	408		2000/...	2.0 16V
C-2688	CILINDRO MESTRE DE EMBREAGEM 15,87mm	GM - CHEVROLET	CRUZE		2013/...	1.8
C-2689	CILINDRO MESTRE DE EMBREAGEM 20,64mm	MERCEDES BENZ - CAMINHÕES	LO-814		TODOS	
C-2689	CILINDRO MESTRE DE EMBREAGEM 20,64mm	MERCEDES BENZ - CAMINHÕES	LO-915		TODOS	
C-2689	CILINDRO MESTRE DE EMBREAGEM 20,64mm	MERCEDES BENZ - CAMINHÕES	LF1634		TODOS	
C-2689	CILINDRO MESTRE DE EMBREAGEM 20,64mm	MERCEDES BENZ - CAMINHÕES	710		TODOS	
C-2689	CILINDRO MESTRE DE EMBREAGEM 20,64mm	MERCEDES BENZ - CAMINHÕES	712		TODOS	
C-2689	CILINDRO MESTRE DE EMBREAGEM 20,64mm	MERCEDES BENZ - CAMINHÕES	1218		TODOS	
C-2689	CILINDRO MESTRE DE EMBREAGEM 20,64mm	MERCEDES BENZ - CAMINHÕES	1318		TODOS	
C-2689	CILINDRO MESTRE DE EMBREAGEM 20,64mm	MERCEDES BENZ - CAMINHÕES	1620		TODOS	
C-2690	CILINDRO MESTRE DE EMBREAGEM 19,05mm	VOLKSWAGEN	AMAROK		2010/...	2.0 TDI (140 cv/180 cv)

Tabela de Conversão	Polegadas	9/16"	5/8"	11/16"	7/10"	3/4"	13/16"	7/8"	15/16"	1"	1 1/16"	1 1/8"	1 1/4"	1 3/8"	1 1/2"	1 5/8"	1 3/4"	1 27/32"	2"
	Milímetros	14,28mm	15,87mm	17,46mm	17,78mm	19,05mm	20,63mm	22,22mm	23,81mm	25,40mm	26,98mm	28,57mm	31,75mm	34,92mm	38,10mm	41,27mm	44,45mm	46,83mm	50,80mm





---

# ATUADOR CONCÊNTRICO DE EMBREAGEM

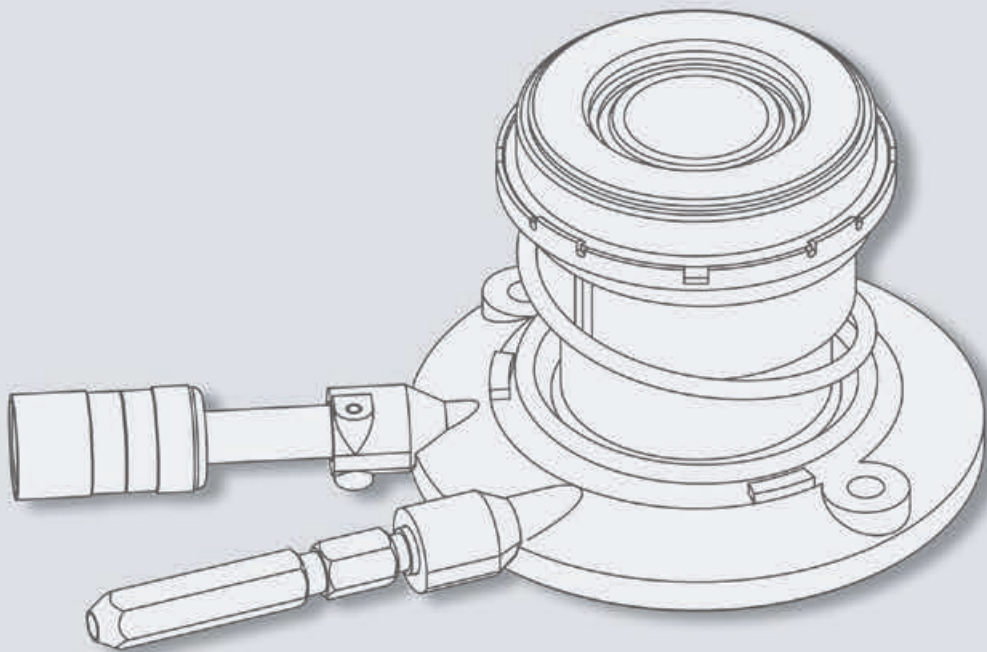

PEÇA	DESCRIÇÃO	MARCA	VEÍCULO		ANOS	SOMENTE PARA
C-2701	CIL. ATUADOR CONCÊNTRICO DE EMBREAGEM	GM - CHEVROLET	VECTRA		1997/2005	MOTOR 2.0/2.2 8V/16V (F-18)
C-2702	CIL. ATUADOR CONCÊNTRICO DE EMBREAGEM	CROSS LANDER	CL-244		2003/2006	
C-2702	CIL. ATUADOR CONCÊNTRICO DE EMBREAGEM	CROSS LANDER	CL-330		2006/2006	
C-2702	CIL. ATUADOR CONCÊNTRICO DE EMBREAGEM	FORD	EXPLORER		1995/2005	
C-2702	CIL. ATUADOR CONCÊNTRICO DE EMBREAGEM	FORD	F-1000		1995/1998	MOTOR 4.9 GASOLINA/2.5 HSD DIESEL
C-2702	CIL. ATUADOR CONCÊNTRICO DE EMBREAGEM	FORD	RANGER		1994/2012	
C-2702	CIL. ATUADOR CONCÊNTRICO DE EMBREAGEM	MAZDA	B-2200		1993/1995	
C-2702	CIL. ATUADOR CONCÊNTRICO DE EMBREAGEM	MAZDA	B-2500		1998/2000	
C-2704	CIL. ATUADOR CONCÊNTRICO DE EMBREAGEM	GM - CHEVROLET	BLAZER		1996/2000	MOTOR 4.3 V6
C-2704	CIL. ATUADOR CONCÊNTRICO DE EMBREAGEM	GM - CHEVROLET	BLAZER		2001/2011	MOTOR 4.3 V6/2.8 DIESEL
C-2704	CIL. ATUADOR CONCÊNTRICO DE EMBREAGEM	GM - CHEVROLET	S-10		1995/2000	MOTOR 4.3 V6
C-2704	CIL. ATUADOR CONCÊNTRICO DE EMBREAGEM	GM - CHEVROLET	S-10		2001/2012	MOTOR 4.3 V6/2.8 DIESEL
C-2705	CIL. ATUADOR CONCÊNTRICO DE EMBREAGEM	GM - CHEVROLET	ASTRA		1999/2003	MOTOR 2.0 16V (F-23)
C-2705	CIL. ATUADOR CONCÊNTRICO DE EMBREAGEM	GM - CHEVROLET	VECTRA		2000/2003	MOTOR 2.2 8V/16V (F-23)
C-2705	CIL. ATUADOR CONCÊNTRICO DE EMBREAGEM	GM - CHEVROLET	ZAFIRA		2002/2003	MOTOR 2.0 16V (F-23)
C-2708	CIL. ATUADOR CONCÊNTRICO DE EMBREAGEM	NISSAN	FRONTIER		1998/2007	
C-2708	CIL. ATUADOR CONCÊNTRICO DE EMBREAGEM	NISSAN	XTERRA		2003/2008	
C-2709	CIL. ATUADOR CONCÊNTRICO DE EMBREAGEM	GM - CHEVROLET	ASTRA		1999/2011	MOTOR 1.8/2.0 8V (F-17)
C-2709	CIL. ATUADOR CONCÊNTRICO DE EMBREAGEM	GM - CHEVROLET	ASTRA		2004/2005	MOTOR 2.0 16V (F-17)
C-2709	CIL. ATUADOR CONCÊNTRICO DE EMBREAGEM	GM - CHEVROLET	COBALT		2011/...	MOTOR 1.4
C-2709	CIL. ATUADOR CONCÊNTRICO DE EMBREAGEM	GM - CHEVROLET	CORSA		2002/2012	MOTOR 1.0
C-2709	CIL. ATUADOR CONCÊNTRICO DE EMBREAGEM	GM - CHEVROLET	CORSA		2002/2012	MOTOR 1.4 / 1.8
C-2709	CIL. ATUADOR CONCÊNTRICO DE EMBREAGEM	GM - CHEVROLET	MERIVA		2003/2012	
C-2709	CIL. ATUADOR CONCÊNTRICO DE EMBREAGEM	GM - CHEVROLET	MONTANA		2004/2010	
C-2709	CIL. ATUADOR CONCÊNTRICO DE EMBREAGEM	GM - CHEVROLET	ONIX		2012/...	MOTOR 1.0 E 1.4 8V
C-2709	CIL. ATUADOR CONCÊNTRICO DE EMBREAGEM	GM - CHEVROLET	PRISMA		2013/...	MOTOR 1.0 E 1.4
C-2709	CIL. ATUADOR CONCÊNTRICO DE EMBREAGEM	GM - CHEVROLET	VECTRA		2004/2005	MOTOR 2.0 8V (F-17)
C-2709	CIL. ATUADOR CONCÊNTRICO DE EMBREAGEM	GM - CHEVROLET	VECTRA		2006/2011	
C-2709	CIL. ATUADOR CONCÊNTRICO DE EMBREAGEM	GM - CHEVROLET	ZAFIRA		2002/2012	MOTOR 2.0 8V (F-17)
C-2709	CIL. ATUADOR CONCÊNTRICO DE EMBREAGEM	GM - CHEVROLET	ZAFIRA		2004/2012	MOTOR 2.0 16V (F-17)
C-2710	CIL. ATUADOR CONCÊNTRICO DE EMBREAGEM	RENAULT	MASTER		2002/2004	MOTOR 2.8 DTI
C-2710	CIL. ATUADOR CONCÊNTRICO DE EMBREAGEM	RENAULT	MASTER		2004/...	MOTOR 2.5 DCI C/ CÂMBIO PK5
C-2711	CIL. ATUADOR CONCÊNTRICO DE EMBREAGEM	FORD	COURIER		1998/...	COM ADAPTADOR
C-2711	CIL. ATUADOR CONCÊNTRICO DE EMBREAGEM	FORD	ECOSPORT		2003/2009	TRAÇÃO 4X2 / SEM ADAPTADOR
C-2711	CIL. ATUADOR CONCÊNTRICO DE EMBREAGEM	FORD	ESCORT		2001/2003	MOTOR 1.6 8v/ COM ADAPTADOR
C-2711	CIL. ATUADOR CONCÊNTRICO DE EMBREAGEM	FORD	ESCORT SW		2001/2003	MOTOR 1.6 8V / COM ADAPTADOR
C-2711	CIL. ATUADOR CONCÊNTRICO DE EMBREAGEM	FORD	FIESTA		1996/2002	COM ADAPTADOR
C-2711	CIL. ATUADOR CONCÊNTRICO DE EMBREAGEM	FORD	FIESTA		2003/2009	SEMADAPTADOR
C-2711	CIL. ATUADOR CONCÊNTRICO DE EMBREAGEM	FORD	FIESTA SEDAN		2005/2009	SEM ADAPTADOR
C-2711	CIL. ATUADOR CONCÊNTRICO DE EMBREAGEM	FORD	FIESTA STREET HATCH		2001/2007	COM ADAPTADOR
C-2711	CIL. ATUADOR CONCÊNTRICO DE EMBREAGEM	FORD	FIESTA STREET SEDAN		2002/2004	COM ADAPTADOR
C-2711	CIL. ATUADOR CONCÊNTRICO DE EMBREAGEM	FORD	FOCUS		2001/2004	MOTOR 1.8 16V / COM ADAPTADOR
C-2711	CIL. ATUADOR CONCÊNTRICO DE EMBREAGEM	FORD	FOCUS		2004/2009	MOTOR 1.6 8V / SEM ADAPTADOR
C-2711	CIL. ATUADOR CONCÊNTRICO DE EMBREAGEM	FORD	FOCUS		2005/2008	MOTOR 2.0 DURATEC / SEM ADAPTADOR
C-2711	CIL. ATUADOR CONCÊNTRICO DE EMBREAGEM	FORD	FOCUS		2010/...	MOTOR 2.0 FLEX / SEM ADAPTADOR
C-2711	CIL. ATUADOR CONCÊNTRICO DE EMBREAGEM	FORD	KA		1997/2007	COM ADAPTADOR
C-2711	CIL. ATUADOR CONCÊNTRICO DE EMBREAGEM	FORD	KA		2008/...	SEM ADAPTADOR
C-2712	CIL. ATUADOR CONCÊNTRICO DE EMBREAGEM	FIAT	DOBLÒ		2005/...	MOTOR 1.8 8V / EtorQ 1.8 16V
C-2712	CIL. ATUADOR CONCÊNTRICO DE EMBREAGEM	FIAT	IDEA		2005/...	MOTOR 1.8 8V / EtorQ 1.8 16V
C-2712	CIL. ATUADOR CONCÊNTRICO DE EMBREAGEM	FIAT	PALIO		2005/...	MOTOR 1.8 8V / EtorQ 1.8 16V
C-2712	CIL. ATUADOR CONCÊNTRICO DE EMBREAGEM	FIAT	PUNTO		2005/...	MOTOR 1.8 8V / EtorQ 1.8 16V
C-2712	CIL. ATUADOR CONCÊNTRICO DE EMBREAGEM	FIAT	SIENA		2005/...	MOTOR 1.8 8V / EtorQ 1.8 16V
C-2712	CIL. ATUADOR CONCÊNTRICO DE EMBREAGEM	FIAT	STILO		2005/...	MOTOR 1.8 8V / EtorQ 1.8 16V
C-2712	CIL. ATUADOR CONCÊNTRICO DE EMBREAGEM	FIAT	STRADA		2005/...	MOTOR 1.8 8V / EtorQ 1.8 16V
C-2713	CIL. ATUADOR CONCÊNTRICO DE EMBREAGEM	NISSAN	LIVINA		2011/...	1.6 16V
C-2713	CIL. ATUADOR CONCÊNTRICO DE EMBREAGEM	NISSAN	MARCH		2011/...	1.6 16V
C-2713	CIL. ATUADOR CONCÊNTRICO DE EMBREAGEM	NISSAN	TIDA		2011/...	1.6 16V
C-2713	CIL. ATUADOR CONCÊNTRICO DE EMBREAGEM	NISSAN	VERSA		2011/...	1.6 16V
C-2714	CIL. ATUADOR CONCÊNTRICO DE EMBREAGEM	RENAULT	DUSTER		2011/2012	1.6 16v
C-2714	CIL. ATUADOR CONCÊNTRICO DE EMBREAGEM	RENAULT	KANGOO		1999/2006	CONECTOR CINZA
C-2714	CIL. ATUADOR CONCÊNTRICO DE EMBREAGEM	RENAULT	MEGANE		1999/2006	CONECTOR CINZA
C-2714	CIL. ATUADOR CONCÊNTRICO DE EMBREAGEM	RENAULT	SCENIC		1999/2006	CONECTOR CINZA
C-2715	CIL. ATUADOR CONCÊNTRICO DE EMBREAGEM	VOLKSWAGEN	AMAROK		2010/...	2.0 TDI (140 cv/180 cv)

BUSCA POR PEÇAS

Tabela de Conversão	Polegadas	9/16"	5/8"	11/16"	7/10"	3/4"	13/16"	7/8"	15/16"	1"	1 1/16"	1 1/8"	1 1/4"	1 3/8"	1 1/2"	1 5/8"	1 3/4"	1 27/32"	2"
	Milímetros	14,28mm	15,87mm	17,46mm	17,78mm	19,05mm	20,63mm	22,22mm	23,81mm	25,40mm	26,98mm	28,57mm	31,75mm	34,92mm	38,10mm	41,27mm	44,45mm	46,83mm	50,80mm



---

## CILINDRO DE RODA

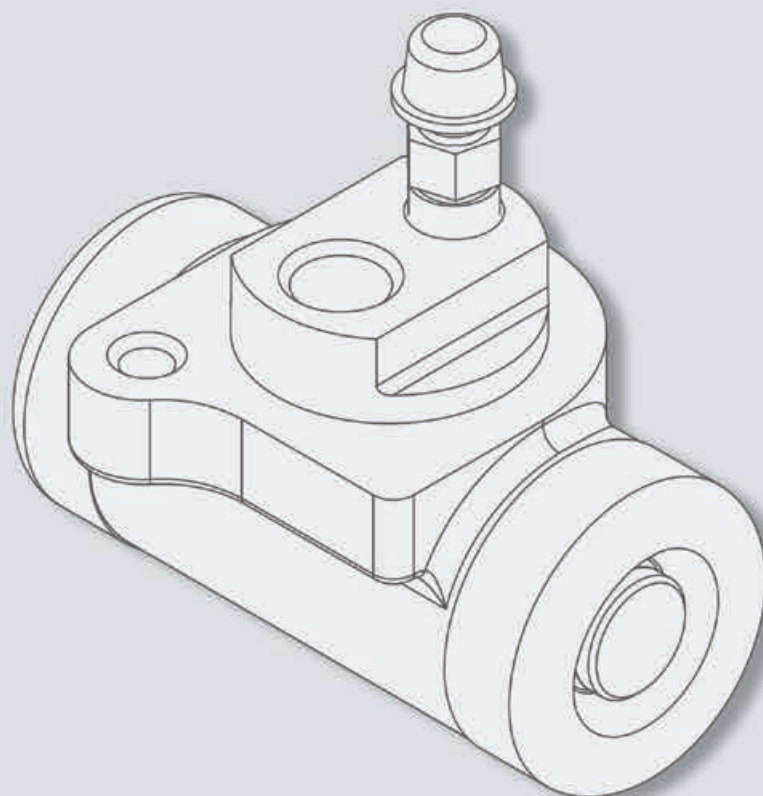



PEÇA	DESCRIÇÃO	MARCA	VEÍCULO		ANOS	SOMENTE PARA
C-3300	CILINDRO DE RODA 41,27mm	MERCEDES BENZ - CAMINHÕES	L/LA/LK/LP/LS/O/OH-321	<-	1957/1965	
C-3300	CILINDRO DE RODA 41,27mm	MERCEDES BENZ - CAMINHÕES	L/LA/LS-1111	<-	1965/1970	
C-3300	CILINDRO DE RODA 41,27mm	MERCEDES BENZ - CAMINHÕES	L/LA/LK/LS/OF-1113	<-	1965/1983	MOD. L/LA/LK/LS
C-3300	CILINDRO DE RODA 41,27mm	MERCEDES BENZ - CAMINHÕES	L/LA/LK/LS/OF-1113	<-	1983/1989	MOD. LA/LK/LS
C-3301	CILINDRO DE RODA 44,45mm	MERCEDES BENZ - CAMINHÕES	L/LA/LK/LP/LS/O/OH-321	->	1965/1970	
C-3301	CILINDRO DE RODA 44,45mm	MERCEDES BENZ - CAMINHÕES	O-352	->	1965/1970	
C-3301	CILINDRO DE RODA 44,45mm	MERCEDES BENZ - CAMINHÕES	L/LA/LK/LS/OF-1113	->	1965/1989	
C-3301	CILINDRO DE RODA 44,45mm	MERCEDES BENZ - CAMINHÕES	L-1116	<-	1983/1989	
C-3301	CILINDRO DE RODA 44,45mm	MERCEDES BENZ - CAMINHÕES	L-2013	->	1974/1989	TERCEIRO EIXO
C-3302	CILINDRO DE RODA 46,83mm	MERCEDES BENZ - CAMINHÕES	O-352	<-	1970/1978	
C-3302	CILINDRO DE RODA 46,83mm	MERCEDES BENZ - CAMINHÕES	O/OH-362/362 A	<-	1978/1989	MOD. O
C-3302	CILINDRO DE RODA 46,83mm	MERCEDES BENZ - CAMINHÕES	O-364	<-	1978/1989	
C-3302	CILINDRO DE RODA 46,83mm	MERCEDES BENZ - CAMINHÕES	L/LS/LK/OF/OH-1313	<-	1976/1989	
C-3302	CILINDRO DE RODA 46,83mm	MERCEDES BENZ - CAMINHÕES	L/OH-1316	<-	1970/1989	
C-3302	CILINDRO DE RODA 46,83mm	MERCEDES BENZ - CAMINHÕES	OH-1416	<-	1970/1989	
C-3302	CILINDRO DE RODA 46,83mm	MERCEDES BENZ - CAMINHÕES	L/LP/OH-1419	<-	1970/1989	
C-3302	CILINDRO DE RODA 46,83mm	MERCEDES BENZ - CAMINHÕES	L/LK-1513/1516	<-	1971/1989	
C-3302	CILINDRO DE RODA 46,83mm	MERCEDES BENZ - CAMINHÕES	OH-1517	<-	1970/1989	
C-3302	CILINDRO DE RODA 46,83mm	MERCEDES BENZ - CAMINHÕES	L-1519	<-	1973/1990	
C-3302	CILINDRO DE RODA 46,83mm	MERCEDES BENZ - CAMINHÕES	L-2013	<-	1973/1989	
C-3302	CILINDRO DE RODA 46,83mm	MERCEDES BENZ - CAMINHÕES	L/LB/LK-2213	<-	1973/1990	
C-3303	CILINDRO DE RODA 50,80mm	MERCEDES BENZ - CAMINHÕES	O/OH-362/362 A	->	1978/1989	MOD. O
C-3303	CILINDRO DE RODA 50,80mm	MERCEDES BENZ - CAMINHÕES	L/LS/LK/OF/OH-1313	->	1976/1989	
C-3303	CILINDRO DE RODA 50,80mm	MERCEDES BENZ - CAMINHÕES	L/OH-1316	->	1970/1989	
C-3303	CILINDRO DE RODA 50,80mm	MERCEDES BENZ - CAMINHÕES	L/LK-1513/1516	->	1971/1976	
C-3303	CILINDRO DE RODA 50,80mm	MERCEDES BENZ - CAMINHÕES	OH-1517	->	1970/1976	
C-3303	CILINDRO DE RODA 50,80mm	MERCEDES BENZ - CAMINHÕES	L-1519	->	1973/1976	
C-3303	CILINDRO DE RODA 50,80mm	MERCEDES BENZ - CAMINHÕES	L-2013	->	1973/1976	
C-3304	CILINDRO DE RODA 22,22mm	MERCEDES BENZ - CAMINHÕES	L/L0-608 D/E	<-	1972/1986	
C-3304	CILINDRO DE RODA 22,22mm	MERCEDES BENZ - CAMINHÕES	L/L0-608 D/E	->	1972/1986	
C-3305	CILINDRO DE RODA ESQUERDA 23,81mm	AGRALE	1600 A/D RS/RD	->	1990/1996	
C-3305	CILINDRO DE RODA ESQUERDA 23,81mm	AGRALE	1800 D RS/RD	->	1990/1996	
C-3305	CILINDRO DE RODA ESQUERDA 23,81mm	AGRALE	VOLARE A5/V5	->	2002/...	
C-3305	CILINDRO DE RODA ESQUERDA 23,81mm	AGRALE	VOLARE A6/V6	->	1998/...	
C-3305	CILINDRO DE RODA ESQUERDA 23,81mm	FORD - CAMINHÕES	F-4000	->	1985/1994	
C-3306	CILINDRO DE RODA DIREITA 23,81mm	AGRALE	1600 A/D RS/RD	->	1990/1996	
C-3306	CILINDRO DE RODA DIREITA 23,81mm	AGRALE	1800 D RS/RD	->	1990/1996	
C-3306	CILINDRO DE RODA DIREITA 23,81mm	AGRALE	VOLARE A5/V5	->	2002/...	
C-3306	CILINDRO DE RODA DIREITA 23,81mm	AGRALE	VOLARE A6/V6	->	1998/...	
C-3306	CILINDRO DE RODA DIREITA 23,81mm	FORD - CAMINHÕES	F-4000	->	1985/1994	
C-3307	CILINDRO DE RODA ESQUERDA 28,57mm	AGRALE	1600 A/D RS/RD	<-	1983/1989	
C-3307	CILINDRO DE RODA ESQUERDA 28,57mm	AGRALE	1800 D RS/RD	<-	1988/1989	
C-3307	CILINDRO DE RODA ESQUERDA 28,57mm	FORD - CAMINHÕES	F-350	<-	1972/1975	
C-3307	CILINDRO DE RODA ESQUERDA 28,57mm	FORD - CAMINHÕES	F-400	<-	1975/1977	
C-3307	CILINDRO DE RODA ESQUERDA 28,57mm	FORD - CAMINHÕES	F-4000	<-	1975/1984	
C-3308	CILINDRO DE RODA DIREITA 28,57mm	AGRALE	1600 A/D RS/RD	<-	1983/1989	
C-3308	CILINDRO DE RODA DIREITA 28,57mm	AGRALE	1800 D RS/RD	<-	1988/1989	
C-3308	CILINDRO DE RODA DIREITA 28,57mm	FORD - CAMINHÕES	F-350	<-	1972/1975	
C-3308	CILINDRO DE RODA DIREITA 28,57mm	FORD - CAMINHÕES	F-400	<-	1975/1977	
C-3308	CILINDRO DE RODA DIREITA 28,57mm	FORD - CAMINHÕES	F-4000	<-	1975/1984	
C-3309	CILINDRO DE RODA ESQUERDA 28,57mm	FORD - CAMINHÕES	F-600	<-	1972/1980	
C-3309	CILINDRO DE RODA ESQUERDA 28,57mm	FORD - CAMINHÕES	F-7000	<-	1972/1980	
C-3309	CILINDRO DE RODA ESQUERDA 28,57mm	FORD - CAMINHÕES	F-11000	<-	1980/1992	
C-3310	CILINDRO DE RODA DIREITA 28,57mm	FORD - CAMINHÕES	F-600	<-	1972/1980	
C-3310	CILINDRO DE RODA DIREITA 28,57mm	FORD - CAMINHÕES	F-7000	<-	1972/1980	
C-3310	CILINDRO DE RODA DIREITA 28,57mm	FORD - CAMINHÕES	F-11000	<-	1980/1992	
C-3311	CILINDRO DE RODA ESQUERDA 31,75mm	FORD - CAMINHÕES	F-350	->	1971/1975	
C-3312	CILINDRO DE RODA DIREITA 31,75mm	FORD - CAMINHÕES	F-350	->	1971/1975	
C-3313	CILINDRO DE RODA ESQUERDA 31,75mm	FORD - CAMINHÕES	F-400	->	1975/1977	
C-3313	CILINDRO DE RODA ESQUERDA 31,75mm	FORD - CAMINHÕES	F-4000	->	1975/1984	
C-3314	CILINDRO DE RODA DIREITA 31,75mm	FORD - CAMINHÕES	F-400	->	1975/1977	
C-3314	CILINDRO DE RODA DIREITA 31,75mm	FORD - CAMINHÕES	F-4000	->	1975/1984	

Tabela de Conversão	Polegadas	9/16"	5/8"	11/16"	7/10"	3/4"	13/16"	7/8"	15/16"	1"	1 1/16"	1 1/8"	1 1/4"	1 3/8"	1 1/2"	1 5/8"	1 3/4"	1 27/32"	2"
	Milímetros	14,28mm	15,87mm	17,46mm	17,78mm	19,05mm	20,63mm	22,22mm	23,81mm	25,40mm	26,98mm	28,57mm	31,75mm	34,92mm	38,10mm	41,27mm	44,45mm	46,83mm	50,80mm

PEÇA	DESCRIÇÃO	MARCA	VEÍCULO		ANOS	SOMENTE PARA
C-3315	CILINDRO DE RODA ESQUERDA SUPERIOR 41,27mm	FIAT - CAMINHÕES	120	<-	1979/1985	
C-3315	CILINDRO DE RODA ESQUERDA SUPERIOR 41,27mm	FIAT - CAMINHÕES	120	->	1979/1985	
C-3315	CILINDRO DE RODA ESQUERDA SUPERIOR 41,27mm	FORD - CAMINHÕES	F-600	->	1960/1980	TERCEIRO EIXO
C-3315	CILINDRO DE RODA ESQUERDA SUPERIOR 41,27mm	FORD - CAMINHÕES	F-600	->	1974/1980	
C-3315	CILINDRO DE RODA ESQUERDA SUPERIOR 41,27mm	FORD - CAMINHÕES	F-7000	->	1972/1980	TERCEIRO EIXO
C-3315	CILINDRO DE RODA ESQUERDA SUPERIOR 41,27mm	FORD - CAMINHÕES	F-7000	->	1974/1980	
C-3315	CILINDRO DE RODA ESQUERDA SUPERIOR 41,27mm	FORD - CAMINHÕES	F-11000	->	1980/1992	TERCEIRO EIXO
C-3315	CILINDRO DE RODA ESQUERDA SUPERIOR 41,27mm	FORD - CAMINHÕES	F-11000	->	1980/1992	
C-3316	CILINDRO DE RODA DIREITA SUPERIOR 41,27mm	FIAT - CAMINHÕES	120	<-	1979/1985	
C-3316	CILINDRO DE RODA DIREITA SUPERIOR 41,27mm	FIAT - CAMINHÕES	120	->	1979/1985	
C-3316	CILINDRO DE RODA DIREITA SUPERIOR 41,27mm	FORD - CAMINHÕES	F-600	->	1960/1980	TERCEIRO EIXO
C-3316	CILINDRO DE RODA DIREITA SUPERIOR 41,27mm	FORD - CAMINHÕES	F-600	->	1974/1980	
C-3316	CILINDRO DE RODA DIREITA SUPERIOR 41,27mm	FORD - CAMINHÕES	F-7000	->	1972/1980	TERCEIRO EIXO
C-3316	CILINDRO DE RODA DIREITA SUPERIOR 41,27mm	FORD - CAMINHÕES	F-7000	->	1974/1980	
C-3316	CILINDRO DE RODA DIREITA SUPERIOR 41,27mm	FORD - CAMINHÕES	F-11000	->	1980/1992	TERCEIRO EIXO
C-3316	CILINDRO DE RODA DIREITA SUPERIOR 41,27mm	FORD - CAMINHÕES	F-11000	->	1980/1992	
C-3317	CILINDRO DE RODA ESQUERDA INFERIOR 41,27mm	FORD - CAMINHÕES	F-600	->	1960/1980	TERCEIRO EIXO
C-3317	CILINDRO DE RODA ESQUERDA INFERIOR 41,27mm	FORD - CAMINHÕES	F-600	->	1974/1980	
C-3317	CILINDRO DE RODA ESQUERDA INFERIOR 41,27mm	FORD - CAMINHÕES	F-7000	->	1972/1980	TERCEIRO EIXO
C-3317	CILINDRO DE RODA ESQUERDA INFERIOR 41,27mm	FORD - CAMINHÕES	F-7000	->	1974/1980	
C-3317	CILINDRO DE RODA ESQUERDA INFERIOR 41,27mm	FORD - CAMINHÕES	F-11000	->	1980/1992	TERCEIRO EIXO
C-3317	CILINDRO DE RODA ESQUERDA INFERIOR 41,27mm	FORD - CAMINHÕES	F-11000	->	1980/1992	
C-3318	CILINDRO DE RODA DIREITA INFERIOR 41,27mm	FORD - CAMINHÕES	F-600	->	1960/1980	TERCEIRO EIXO
C-3318	CILINDRO DE RODA DIREITA INFERIOR 41,27mm	FORD - CAMINHÕES	F-600	->	1974/1980	
C-3318	CILINDRO DE RODA DIREITA INFERIOR 41,27mm	FORD - CAMINHÕES	F-7000	->	1972/1980	TERCEIRO EIXO
C-3318	CILINDRO DE RODA DIREITA INFERIOR 41,27mm	FORD - CAMINHÕES	F-7000	->	1974/1980	
C-3318	CILINDRO DE RODA DIREITA INFERIOR 41,27mm	FORD - CAMINHÕES	F-11000	->	1980/1992	TERCEIRO EIXO
C-3318	CILINDRO DE RODA DIREITA INFERIOR 41,27mm	FORD - CAMINHÕES	F-11000	->	1980/1992	
C-3319	CILINDRO DE RODA 25,40mm	GM - CAMINHÕES	C-60	<-	1978/1979	
C-3319	CILINDRO DE RODA 25,40mm	GM - CAMINHÕES	D-60 (11000/12000)	<-	1978/1979	
C-3320	CILINDRO DE RODA ESQUERDA SUPERIOR 34,92mm	GM - CAMINHÕES	C-60	<-	1980/1984	
C-3320	CILINDRO DE RODA ESQUERDA SUPERIOR 34,92mm	GM - CAMINHÕES	D-60 (11000/12000)	<-	1980/1996	
C-3320	CILINDRO DE RODA ESQUERDA SUPERIOR 34,92mm	GM - CAMINHÕES	D-80 (19000)	<-	1982/1984	
C-3320	CILINDRO DE RODA ESQUERDA SUPERIOR 34,92mm	VOLKSWAGEN - CAMINHÕES	11-130	<-	1982/1985	
C-3321	CILINDRO DE RODA DIREITA SUPERIOR 34,92mm	GM - CAMINHÕES	C-60	<-	1980/1984	
C-3321	CILINDRO DE RODA DIREITA SUPERIOR 34,92mm	GM - CAMINHÕES	D-60 (11000/12000)	<-	1980/1996	
C-3321	CILINDRO DE RODA DIREITA SUPERIOR 34,92mm	GM - CAMINHÕES	D-80 (19000)	<-	1982/1984	
C-3321	CILINDRO DE RODA DIREITA SUPERIOR 34,92mm	VOLKSWAGEN - CAMINHÕES	11-130	<-	1982/1985	
C-3322	CILINDRO DE RODA ESQUERDA INFERIOR 34,92mm	GM - CAMINHÕES	C-60	<-	1980/1984	
C-3322	CILINDRO DE RODA ESQUERDA INFERIOR 34,92mm	GM - CAMINHÕES	D-60 (11000/12000)	<-	1980/1996	
C-3322	CILINDRO DE RODA ESQUERDA INFERIOR 34,92mm	GM - CAMINHÕES	D-80 (19000)	<-	1982/1984	
C-3322	CILINDRO DE RODA ESQUERDA INFERIOR 34,92mm	VOLKSWAGEN - CAMINHÕES	11-130	<-	1982/1985	
C-3323	CILINDRO DE RODA DIREITA INFERIOR 34,92mm	GM - CAMINHÕES	C-60	<-	1980/1984	
C-3323	CILINDRO DE RODA DIREITA INFERIOR 34,92mm	GM - CAMINHÕES	D-60 (11000/12000)	<-	1980/1996	
C-3323	CILINDRO DE RODA DIREITA INFERIOR 34,92mm	GM - CAMINHÕES	D-80 (19000)	<-	1982/1984	
C-3323	CILINDRO DE RODA DIREITA INFERIOR 34,92mm	VOLKSWAGEN - CAMINHÕES	11-130	<-	1982/1985	
C-3324	CILINDRO DE RODA ESQUERDA SUPERIOR 41,27mm	GM - CAMINHÕES	C-60	->	1972/1979	
C-3324	CILINDRO DE RODA ESQUERDA SUPERIOR 41,27mm	GM - CAMINHÕES	D-60 (11000/12000)	->	1972/1979	
C-3325	CILINDRO DE RODA DIREITA SUPERIOR 41,27mm	GM - CAMINHÕES	C-60	->	1972/1979	
C-3325	CILINDRO DE RODA DIREITA SUPERIOR 41,27mm	GM - CAMINHÕES	D-60 (11000/12000)	->	1972/1979	
C-3326	CILINDRO DE RODA ESQUERDA INFERIOR 41,27mm	GM - CAMINHÕES	C-60	->	1972/1979	
C-3326	CILINDRO DE RODA ESQUERDA INFERIOR 41,27mm	GM - CAMINHÕES	D-60 (11000/12000)	->	1972/1979	
C-3327	CILINDRO DE RODA DIREITA INFERIOR 41,27mm	GM - CAMINHÕES	C-60	->	1972/1979	
C-3327	CILINDRO DE RODA DIREITA INFERIOR 41,27mm	GM - CAMINHÕES	D-60 (11000/12000)	->	1972/1979	
C-3328	CILINDRO DE RODA ESQUERDA INFERIOR 44,45mm	GM - CAMINHÕES	C-60	->	1980/1984	
C-3328	CILINDRO DE RODA ESQUERDA INFERIOR 44,45mm	GM - CAMINHÕES	D-60 (11000/12000)	->	1980/1996	
C-3328	CILINDRO DE RODA ESQUERDA INFERIOR 44,45mm	GM - CAMINHÕES	D-80 (19000)	->	1982/1984	
C-3329	CILINDRO DE RODA DIREITA INFERIOR 44,45mm	GM - CAMINHÕES	C-60	->	1980/1984	
C-3329	CILINDRO DE RODA DIREITA INFERIOR 44,45mm	GM - CAMINHÕES	D-60 (11000/12000)	->	1980/1996	
C-3329	CILINDRO DE RODA DIREITA INFERIOR 44,45mm	GM - CAMINHÕES	D-80 (19000)	->	1982/1984	
C-3330	CILINDRO DE RODA ESQUERDA SUPERIOR 44,45mm	GM - CAMINHÕES	C-60	->	1980/1984	
C-3330	CILINDRO DE RODA ESQUERDA SUPERIOR 44,45mm	GM - CAMINHÕES	D-60 (11000/12000)	->	1980/1996	

Polgadas	9/16"	5/8"	11/16"	7/10"	3/4"	13/16"	7/8"	15/16"	1"	1 1/16"	1 1/8"	1 1/4"	1 3/8"	1 1/2"	1 5/8"	1 3/4"	1 27/32"	2"
Milímetros	14,28mm	15,87mm	17,46mm	17,78mm	19,05mm	20,63mm	22,22mm	23,81mm	25,40mm	26,98mm	28,57mm	31,75mm	34,92mm	38,10mm	41,27mm	44,45mm	46,83mm	50,80mm



PEÇA	DESCRIÇÃO	MARCA	VEÍCULO		ANOS	SOMENTE PARA
C-3330	CILINDRO DE RODA ESQUERDA SUPERIOR 44,45mm	GM - CAMINHÕES	D-80 (19000)	->	1982/1984	
C-3331	CILINDRO DE RODA DIREITA SUPERIOR 44,45mm	GM - CAMINHÕES	C-60	->	1980/1984	
C-3331	CILINDRO DE RODA DIREITA SUPERIOR 44,45mm	GM - CAMINHÕES	D-60 (11000/12000)	->	1980/1996	
C-3331	CILINDRO DE RODA DIREITA SUPERIOR 44,45mm	GM - CAMINHÕES	D-80 (19000)	->	1982/1984	
C-3332	CILINDRO DE RODA 23,81mm	MERCEDES BENZ - CAMINHÕES	L/LO-708 D/E	<-	1987/1988	
C-3332	CILINDRO DE RODA 23,81mm	MERCEDES BENZ - CAMINHÕES	L/LO-708 D/E	->	1987/1988	
C-3333	CILINDRO DE RODA 38,10mm	VOLKSWAGEN - CAMINHÕES	Jun-80	<-	1982/1986	
C-3333	CILINDRO DE RODA 38,10mm	VOLKSWAGEN - CAMINHÕES	Jun-80	->	1982/1986	
C-3333	CILINDRO DE RODA 38,10mm	VOLKSWAGEN - CAMINHÕES	Jun-90	<-	1982/1986	
C-3333	CILINDRO DE RODA 38,10mm	VOLKSWAGEN - CAMINHÕES	Jun-90	->	1982/1986	
C-3333	CILINDRO DE RODA 38,10mm	VOLKSWAGEN - CAMINHÕES	Jul-90	<-	1987/1994	
C-3333	CILINDRO DE RODA 38,10mm	VOLKSWAGEN - CAMINHÕES	Jul-90	->	1987/1994	
C-3333	CILINDRO DE RODA 38,10mm	VOLKSWAGEN - CAMINHÕES	7-110 S	<-	1988/1994	
C-3333	CILINDRO DE RODA 38,10mm	VOLKSWAGEN - CAMINHÕES	7-110 S	->	1988/1994	
C-3334	CILINDRO DE RODA 28,57mm	MERCEDES BENZ - CAMINHÕES	L-709	->	1989/1996	
C-3334	CILINDRO DE RODA 28,57mm	MERCEDES BENZ - CAMINHÕES	L-710	->	1996/2002	
C-3334	CILINDRO DE RODA 28,57mm	MERCEDES BENZ - CAMINHÕES	L/LO-912	->	1989/...	
C-3335	CILINDRO DE RODA ESQUERDA 31,75mm	GM - CAMINHÕES	D-40	->	1985/1997	
C-3335	CILINDRO DE RODA ESQUERDA 31,75mm	GMC	6-100	->	1998/2002	
C-3335	CILINDRO DE RODA ESQUERDA 31,75mm	GMC	6-150	->	1998/2002	
C-3336	CILINDRO DE RODA DIREITA 31,75mm	GM - CAMINHÕES	D-40	->	1985/1997	
C-3336	CILINDRO DE RODA DIREITA 31,75mm	GMC	6-100	->	1998/2002	
C-3336	CILINDRO DE RODA DIREITA 31,75mm	GMC	6-150	->	1998/2002	
C-3337	CILINDRO DE RODA ESQUERDA 25,40mm	FORD - CAMINHÕES	F-4000	->	1995/1998	
C-3338	CILINDRO DE RODA DIREITA 25,40mm	FORD - CAMINHÕES	F-4000	->	1995/1998	
C-3350	CILINDRO DE RODA 14,28mm	FORD	VERSAILLES	->	1991/1994	
C-3350	CILINDRO DE RODA 14,28mm	VOLKSWAGEN	GOL (G1)	->	1980/1996	
C-3350	CILINDRO DE RODA 14,28mm	VOLKSWAGEN	GOL (G2)	->	1995/2005	MOTOR 1.0/1.6/1.8 S/ABS
C-3350	CILINDRO DE RODA 14,28mm	VOLKSWAGEN	GOL (G3)	->	2000/2005	MOTOR 1.0/1.6/1.8 S/ABS
C-3350	CILINDRO DE RODA 14,28mm	VOLKSWAGEN	GOL (G4)	->	2006/...	
C-3350	CILINDRO DE RODA 14,28mm	VOLKSWAGEN	PASSAT	->	1973/1989	
C-3350	CILINDRO DE RODA 14,28mm	VOLKSWAGEN	SANTANA	->	1984/1994	
C-3350	CILINDRO DE RODA 14,28mm	VOLKSWAGEN	VOYAGE (G1)	->	1982/1996	
C-3351	CILINDRO DE RODA 22,22mm	GURGEL	X-12/TOCANTINS	<-	1969/1980	
C-3351	CILINDRO DE RODA 22,22mm	PUMA	GT/GTE/GTS	<-	1968/1973	
C-3351	CILINDRO DE RODA 22,22mm	VOLKSWAGEN	FUSCA	<-	1957/1984	
C-3351	CILINDRO DE RODA 22,22mm	VOLKSWAGEN	KARMANN GHIA	<-	1957/1969	
C-3352	CILINDRO DE RODA 19,05mm	PUMA	GT/GTE/GTS	->	1974/1976	
C-3352	CILINDRO DE RODA 19,05mm	VOLKSWAGEN	FUSCA	->	1977/1996	
C-3353	CILINDRO DE RODA 19,05mm	FIAT	ELBA	->	1986/1996	
C-3353	CILINDRO DE RODA 19,05mm	FIAT	FIORINO (mod. Uno)	->	1988/1993	
C-3353	CILINDRO DE RODA 19,05mm	FIAT	PRÊMIO	->	1985/1996	EXCETO DUNA
C-3353	CILINDRO DE RODA 19,05mm	FIAT	UNO	->	1984/2008	
C-3354	CILINDRO DE RODA 19,05mm	GM - CHEVROLET	CHEVETTE	->	1973/1986	SIST. BOSCH
C-3354	CILINDRO DE RODA 19,05mm	GM - CHEVROLET	CHEVY	->	1983/1986	SIST. BOSCH
C-3354	CILINDRO DE RODA 19,05mm	GM - CHEVROLET	MARAJÓ	->	1981/1986	SIST. BOSCH
C-3355	CILINDRO DE RODA 19,05mm	FIAT	147/SPAZIO	->	1976/1987	
C-3355	CILINDRO DE RODA 19,05mm	FIAT	FIORINO (mod. 147)	->	1978/1988	
C-3355	CILINDRO DE RODA 19,05mm	FIAT	OGGI	->	1983/1985	
C-3355	CILINDRO DE RODA 19,05mm	FIAT	PANORAMA	->	1980/1987	
C-3356	CILINDRO DE RODA 17,46mm	FORD	ROYALE	->	1992/1996	
C-3356	CILINDRO DE RODA 17,46mm	FORD	VERSAILLES	->	1991/1994	C/ CÂMBIO AUTOMÁTICO
C-3356	CILINDRO DE RODA 17,46mm	FORD	VERSAILLES	->	1995/1996	
C-3356	CILINDRO DE RODA 17,46mm	VOLKSWAGEN	CROSSFOX	->	2005/...	
C-3356	CILINDRO DE RODA 17,46mm	VOLKSWAGEN	FOX	->	2004/...	
C-3356	CILINDRO DE RODA 17,46mm	VOLKSWAGEN	GOL (G2)	->	1995/1997	C/ABS
C-3356	CILINDRO DE RODA 17,46mm	VOLKSWAGEN	GOL (G2)	->	1995/2000	MOTOR 2.0 S/ABS
C-3356	CILINDRO DE RODA 17,46mm	VOLKSWAGEN	GOL (G3)	->	2000/2002	MOTOR 2.0 S/ABS
C-3356	CILINDRO DE RODA 17,46mm	VOLKSWAGEN	GOL (G3)	->	2000/2004	MOTOR 1.0 TURBO S/ABS
C-3356	CILINDRO DE RODA 17,46mm	VOLKSWAGEN	GOL (G5)	->	2009/...	C/ABS
C-3356	CILINDRO DE RODA 17,46mm	VOLKSWAGEN	GOLF	->	1996/1998	MOD. GL (fabr. México)
C-3356	CILINDRO DE RODA 17,46mm	VOLKSWAGEN	PARATI (G1)	->	1983/1996	

Tabela de Conversão	Polegadas	9/16"	5/8"	11/16"	7/10"	3/4"	13/16"	7/8"	15/16"	1"	1 1/16"	1 1/8"	1 1/4"	1 3/8"	1 1/2"	1 5/8"	1 3/4"	1 27/32"	2"
	Milímetros	14,28mm	15,87mm	17,46mm	17,78mm	19,05mm	20,63mm	22,22mm	23,81mm	25,40mm	26,98mm	28,57mm	31,75mm	34,92mm	38,10mm	41,27mm	44,45mm	46,83mm	50,80mm

PEÇA	DESCRIÇÃO	MARCA	VEÍCULO		ANOS	SOMENTE PARA
C-3356	CILINDRO DE RODA 17,46mm	VOLKSWAGEN	PARATI (G2, G3 e G4)	->	1996/1997	C/ABS
C-3356	CILINDRO DE RODA 17,46mm	VOLKSWAGEN	POLO	->	2002/...	
C-3356	CILINDRO DE RODA 17,46mm	VOLKSWAGEN	QUANTUM	->	1985/2002	
C-3356	CILINDRO DE RODA 17,46mm	VOLKSWAGEN	SANTANA	->	1984/1994	C/ CÂMBIO AUTOMÁTICO
C-3356	CILINDRO DE RODA 17,46mm	VOLKSWAGEN	SANTANA	->	1995/2006	
C-3356	CILINDRO DE RODA 17,46mm	VOLKSWAGEN	SAVEIRO (G1)	->	1987/1997	
C-3357	CILINDRO DE RODA 22,22mm	GURGEL	X-12/TOCANTINS	->	1981/1993	
C-3357	CILINDRO DE RODA 22,22mm	GURGEL	XEF	->	1984/1986	
C-3357	CILINDRO DE RODA 22,22mm	PUMA	GT/GTE/GTS	->	1977/1984	
C-3357	CILINDRO DE RODA 22,22mm	VOLKSWAGEN	BRASILIA	->	1973/1982	
C-3357	CILINDRO DE RODA 22,22mm	VOLKSWAGEN	KARMANN GHIA TC	->	1970/1976	
C-3357	CILINDRO DE RODA 22,22mm	VOLKSWAGEN	SEDAN 1600 4 PORTAS	->	1969/1971	
C-3357	CILINDRO DE RODA 22,22mm	VOLKSWAGEN	SP-1/SP-2	->	1972/1975	
C-3357	CILINDRO DE RODA 22,22mm	VOLKSWAGEN	TL	->	1969/1976	
C-3357	CILINDRO DE RODA 22,22mm	VOLKSWAGEN	VARIANT	->	1970/1977	
C-3357	CILINDRO DE RODA 22,22mm	VOLKSWAGEN	VARIANT II	->	1978/1980	
C-3358	CILINDRO DE RODA ESQUERDA 19,05mm	FORD	BELINA	->	1969/1977	
C-3358	CILINDRO DE RODA ESQUERDA 19,05mm	FORD	BELINA II	->	1978/1991	SIST. BENDIX
C-3358	CILINDRO DE RODA ESQUERDA 19,05mm	FORD	CORCEL II	->	1978/1986	SIST. BENDIX
C-3358	CILINDRO DE RODA ESQUERDA 19,05mm	FORD	DEL REY	->	1981/1991	SIST. BENDIX
C-3359	CILINDRO DE RODA DIREITA 19,05mm	FORD	BELINA	->	1969/1977	
C-3359	CILINDRO DE RODA DIREITA 19,05mm	FORD	BELINA II	->	1978/1991	SIST. BENDIX
C-3359	CILINDRO DE RODA DIREITA 19,05mm	FORD	CORCEL II	->	1978/1986	SIST. BENDIX
C-3359	CILINDRO DE RODA DIREITA 19,05mm	FORD	DEL REY	->	1981/1991	SIST. BENDIX
C-3362	CILINDRO DE RODA ESQUERDA 25,40mm	GM - CHEVROLET	D-10	->	1979/1984	
C-3362	CILINDRO DE RODA ESQUERDA 25,40mm	GM - CHEVROLET	D-20	->	1985/1992	
C-3362	CILINDRO DE RODA ESQUERDA 25,40mm	GM - CHEVROLET	VERANEIO	->	1979/1992	
C-3363	CILINDRO DE RODA DIREITA 25,40mm	GM - CHEVROLET	D-10	->	1979/1984	
C-3363	CILINDRO DE RODA DIREITA 25,40mm	GM - CHEVROLET	D-20	->	1985/1992	
C-3363	CILINDRO DE RODA DIREITA 25,40mm	GM - CHEVROLET	VERANEIO	->	1979/1992	
C-3364	CILINDRO DE RODA ESQUERDA 19,05mm	GM - CHEVROLET	MONZA	->	1981/1987	
C-3365	CILINDRO DE RODA DIREITA 19,05mm	GM - CHEVROLET	MONZA	->	1981/1987	
C-3366	CILINDRO DE RODA 23,81mm	GURGEL	G-15	->	1983/1984	
C-3366	CILINDRO DE RODA 23,81mm	GURGEL	G-800 CS/CD	->	1983/1991	
C-3366	CILINDRO DE RODA 23,81mm	GURGEL	X-15/CARAJÁS	->	1985/1993	
C-3366	CILINDRO DE RODA 23,81mm	VOLKSWAGEN	KOMBI	->	1982/...	
C-3367	CILINDRO DE RODA 23,81mm	GURGEL	G-15	->	1980/1981	
C-3367	CILINDRO DE RODA 23,81mm	VOLKSWAGEN	KOMBI	->	1976/1982	
C-3368	CILINDRO DE RODA 19,05mm	FORD	PAMPA	->	1982/1997	C/ TRAÇÃO 4X2
C-3369	CILINDRO DE RODA ESQUERDA 22,22mm	GM - CHEVROLET	CORSA PICK-UP	->	1995/2003	
C-3369	CILINDRO DE RODA ESQUERDA 22,22mm	GM - CHEVROLET	IPANEMA	->	1990/1998	SIST. ATE
C-3369	CILINDRO DE RODA ESQUERDA 22,22mm	GM - CHEVROLET	MONZA	->	1988/1996	SIST. ATE
C-3370	CILINDRO DE RODA DIREITA 22,22mm	GM - CHEVROLET	CORSA PICK-UP	->	1995/2003	
C-3370	CILINDRO DE RODA DIREITA 22,22mm	GM - CHEVROLET	IPANEMA	->	1990/1998	SIST. ATE
C-3370	CILINDRO DE RODA DIREITA 22,22mm	GM - CHEVROLET	MONZA	->	1988/1996	SIST. ATE
C-3371	CILINDRO DE RODA ESQUERDA 22,22mm	GM - CHEVROLET	CARAVAN	->	1981/1992	SIST. VARGA
C-3371	CILINDRO DE RODA ESQUERDA 22,22mm	GM - CHEVROLET	OPALA	->	1981/1992	SIST. VARGA
C-3372	CILINDRO DE RODA DIREITA 22,22mm	GM - CHEVROLET	CARAVAN	->	1981/1992	SIST. VARGA
C-3372	CILINDRO DE RODA DIREITA 22,22mm	GM - CHEVROLET	OPALA	->	1981/1992	SIST. VARGA
C-3373	CILINDRO DE RODA 22,22mm	GM - CHEVROLET	CHEVETTE	->	1987/1994	SIST. VARGA
C-3373	CILINDRO DE RODA 22,22mm	GM - CHEVROLET	CHEVY	->	1987/1995	SIST. VARGA
C-3373	CILINDRO DE RODA 22,22mm	GM - CHEVROLET	MARAJÓ	->	1987/1989	SIST. VARGA
C-3374	CILINDRO DE RODA 22,22mm	GM - CHEVROLET	CHEVETTE	->	1987/1994	SIST. BOSCH
C-3374	CILINDRO DE RODA 22,22mm	GM - CHEVROLET	CHEVY	->	1987/1995	SIST. BOSCH
C-3374	CILINDRO DE RODA 22,22mm	GM - CHEVROLET	MARAJÓ	->	1987/1989	SIST. BOSCH
C-3375	CILINDRO DE RODA 17,46mm	GURGEL	X-12/TOCANTINS	->	1969/1980	
C-3375	CILINDRO DE RODA 17,46mm	PUMA	GT/GTE/GTS	->	1968/1973	
C-3375	CILINDRO DE RODA 17,46mm	VOLKSWAGEN	FUSCA	->	1970/1976	C/ EIXO 4 FUROS
C-3376	CILINDRO DE RODA ESQUERDA 25,40mm	FORD	F-1000	->	1979/1998	
C-3377	CILINDRO DE RODA DIREITA 25,40mm	FORD	F-1000	->	1979/1998	
C-3378	CILINDRO DE RODA ESQUERDA 28,57mm	FORD	AERO/ITAMARATY	<-	1961/1961	
C-3378	CILINDRO DE RODA ESQUERDA 28,57mm	FORD	JEEP	<-	1960/1983	

Tabela de Conversão	Polegadas	9/16"	5/8"	11/16"	7/10"	3/4"	13/16"	7/8"	15/16"	1"	1 1/16"	1 1/8"	1 1/4"	1 3/8"	1 1/2"	1 5/8"	1 3/4"	1 27/32"	2"
	Milímetros	14,28mm	15,87mm	17,46mm	17,78mm	19,05mm	20,63mm	22,22mm	23,81mm	25,40mm	26,98mm	28,57mm	31,75mm	34,92mm	38,10mm	41,27mm	44,45mm	46,83mm	50,80mm



PEÇA	DESCRIÇÃO	MARCA	VEÍCULO		ANOS	SOMENTE PARA
C-3378	CILINDRO DE RODA ESQUERDA 28,57mm	FORD	RURAL	<-	1960/1977	
C-3379	CILINDRO DE RODA DIREITA 28,57mm	FORD	AERO/ITAMARATY	<-	1961/1961	
C-3379	CILINDRO DE RODA DIREITA 28,57mm	FORD	JEEP	<-	1960/1983	
C-3379	CILINDRO DE RODA DIREITA 28,57mm	FORD	RURAL	<-	1960/1977	
C-3380	CILINDRO DE RODA ESQUERDA 25,40mm	FORD	AERO/ITAMARATY	->	1961/1961	
C-3380	CILINDRO DE RODA ESQUERDA 25,40mm	FORD	F-75	->	1960/1961	C/ FREIO ESTAC. NO CARDAN
C-3380	CILINDRO DE RODA ESQUERDA 25,40mm	FORD	JEEP	->	1960/1983	
C-3380	CILINDRO DE RODA ESQUERDA 25,40mm	FORD	RURAL	->	1960/1977	
C-3381	CILINDRO DE RODA DIREITA 25,40mm	FORD	AERO/ITAMARATY	->	1961/1961	
C-3381	CILINDRO DE RODA DIREITA 25,40mm	FORD	F-75	->	1960/1961	C/ FREIO ESTAC. NO CARDAN
C-3381	CILINDRO DE RODA DIREITA 25,40mm	FORD	JEEP	->	1960/1983	
C-3381	CILINDRO DE RODA DIREITA 25,40mm	FORD	RURAL	->	1960/1977	
C-3382	CILINDRO DE RODA ESQUERDA ANTERIOR 22,22mm	TOYOTA	BANDEIRANTE	->	1980/1996	C/ <-
C-3383	CILINDRO DE RODA ESQUERDA POSTERIOR 22,22mm	TOYOTA	BANDEIRANTE	->	1980/1996	C/ <-
C-3384	CILINDRO DE RODA DIREITA ANTERIOR 22,22mm	TOYOTA	BANDEIRANTE	->	1980/1996	C/ <-
C-3385	CILINDRO DE RODA DIREITA POSTERIOR 22,22mm	TOYOTA	BANDEIRANTE	->	1980/1996	C/ <-
C-3386	CILINDRO DE RODA ESQUERDA ANTERIOR 25,40mm	TOYOTA	BANDEIRANTE	<-	1980/1996	
C-3387	CILINDRO DE RODA ESQUERDA POSTERIOR 25,40mm	TOYOTA	BANDEIRANTE	<-	1980/1996	
C-3388	CILINDRO DE RODA DIREITA ANTERIOR 25,40mm	TOYOTA	BANDEIRANTE	<-	1980/1996	
C-3389	CILINDRO DE RODA DIREITA POSTERIOR 25,40mm	TOYOTA	BANDEIRANTE	<-	1980/1996	
C-3390	CILINDRO DE RODA ESQUERDA 28,57mm	FORD	AERO/ITAMARATY	<-	1961/1971	
C-3390	CILINDRO DE RODA ESQUERDA 28,57mm	FORD	F-75	<-	1960/1982	
C-3390	CILINDRO DE RODA ESQUERDA 28,57mm	FORD	GALAXIE	<-	1967/1968	
C-3390	CILINDRO DE RODA ESQUERDA 28,57mm	GM - CHEVROLET	3100	<-	1956/1963	
C-3391	CILINDRO DE RODA DIREITA 28,57mm	FORD	AERO/ITAMARATY	<-	1961/1971	
C-3391	CILINDRO DE RODA DIREITA 28,57mm	FORD	F-75	<-	1960/1982	
C-3391	CILINDRO DE RODA DIREITA 28,57mm	FORD	GALAXIE	<-	1967/1968	
C-3391	CILINDRO DE RODA DIREITA 28,57mm	GM - CHEVROLET	3100	<-	1956/1963	
C-3392	CILINDRO DE RODA ESQUERDA 25,40mm	FORD	AERO/ITAMARATY	->	1961/1962	
C-3392	CILINDRO DE RODA ESQUERDA 25,40mm	FORD	F-75	->	1960/1982	
C-3392	CILINDRO DE RODA ESQUERDA 25,40mm	GM - CHEVROLET	3100	->	1956/1967	
C-3392	CILINDRO DE RODA ESQUERDA 25,40mm	GM - CHEVROLET	C-10/14/15/16	->	1968/1978	
C-3392	CILINDRO DE RODA ESQUERDA 25,40mm	GM - CHEVROLET	VERANEIO	->	1968/1978	
C-3393	CILINDRO DE RODA DIREITA 25,40mm	FORD	AERO/ITAMARATY	->	1961/1962	
C-3393	CILINDRO DE RODA DIREITA 25,40mm	FORD	F-75	->	1960/1982	
C-3393	CILINDRO DE RODA DIREITA 25,40mm	GM - CHEVROLET	3100	->	1956/1967	
C-3393	CILINDRO DE RODA DIREITA 25,40mm	GM - CHEVROLET	C-10/14/15/16	->	1968/1978	
C-3393	CILINDRO DE RODA DIREITA 25,40mm	GM - CHEVROLET	VERANEIO	->	1968/1978	
C-3394	CILINDRO DE RODA 19,05mm	GM - CHEVROLET	CHEVETTE	->	1978/1986	SIST. VARGA
C-3394	CILINDRO DE RODA 19,05mm	GM - CHEVROLET	CHEVY	->	1983/1986	SIST. VARGA
C-3394	CILINDRO DE RODA 19,05mm	GM - CHEVROLET	MARAJÓ	->	1981/1986	SIST. VARGA
C-3395	CILINDRO DE RODA ESQUERDA 19,05mm	GM - CHEVROLET	CARAVAN	->	1975/1978	
C-3395	CILINDRO DE RODA ESQUERDA 19,05mm	GM - CHEVROLET	OPALA	->	1971/1978	
C-3395	CILINDRO DE RODA ESQUERDA 19,05mm	PUMA	GTB	->	1974/1978	
C-3396	CILINDRO DE RODA DIREITA 19,05mm	GM - CHEVROLET	CARAVAN	->	1975/1978	
C-3396	CILINDRO DE RODA DIREITA 19,05mm	GM - CHEVROLET	OPALA	->	1971/1978	
C-3396	CILINDRO DE RODA DIREITA 19,05mm	PUMA	GTB	->	1974/1978	
C-3397	CILINDRO DE RODA ESQUERDA 19,05mm	FORD	BELINA II	->	1978/1991	SIST. VARGA
C-3397	CILINDRO DE RODA ESQUERDA 19,05mm	FORD	CORCEL II	->	1978/1986	SIST. VARGA
C-3397	CILINDRO DE RODA ESQUERDA 19,05mm	FORD	DEL REY	->	1981/1991	SIST. VARGA
C-3398	CILINDRO DE RODA DIREITA 19,05mm	FORD	BELINA II	->	1978/1991	SIST. VARGA
C-3398	CILINDRO DE RODA DIREITA 19,05mm	FORD	CORCEL II	->	1978/1986	SIST. VARGA
C-3398	CILINDRO DE RODA DIREITA 19,05mm	FORD	DEL REY	->	1981/1991	SIST. VARGA
C-3399	CILINDRO DE RODA ESQUERDA SUPERIOR 25,40mm	GURGEL	E-400	<-	1981/1983	
C-3399	CILINDRO DE RODA ESQUERDA SUPERIOR 25,40mm	GURGEL	G-15	<-	1980/1981	
C-3399	CILINDRO DE RODA ESQUERDA SUPERIOR 25,40mm	GURGEL	X-20	<-	1977/1979	
C-3399	CILINDRO DE RODA ESQUERDA SUPERIOR 25,40mm	VOLKSWAGEN	KOMBI	<-	1967/1982	
C-3400	CILINDRO DE RODA DIREITA SUPERIOR 25,40mm	GURGEL	E-400	<-	1981/1983	
C-3400	CILINDRO DE RODA DIREITA SUPERIOR 25,40mm	GURGEL	G-15	<-	1980/1981	
C-3400	CILINDRO DE RODA DIREITA SUPERIOR 25,40mm	GURGEL	X-20	<-	1977/1979	
C-3400	CILINDRO DE RODA DIREITA SUPERIOR 25,40mm	VOLKSWAGEN	KOMBI	<-	1967/1982	
C-3401	CILINDRO DE RODA ESQUERDA INFERIOR 25,40mm	GURGEL	E-400	<-	1981/1983	

Tabela de Conversão	Polegadas	9/16"	5/8"	11/16"	7/10"	3/4"	13/16"	7/8"	15/16"	1"	1 1/16"	1 1/8"	1 1/4"	1 3/8"	1 1/2"	1 5/8"	1 3/4"	1 27/32"	2"
	Milímetros	14,28mm	15,87mm	17,46mm	17,78mm	19,05mm	20,63mm	22,22mm	23,81mm	25,40mm	26,98mm	28,57mm	31,75mm	34,92mm	38,10mm	41,27mm	44,45mm	46,83mm	50,80mm

PEÇA	DESCRIÇÃO	MARCA	VEÍCULO		ANOS	SOMENTE PARA
C-3401	CILINDRO DE RODA ESQUERDA INFERIOR 25,40mm	GURGEL	G-15	<-	1980/1981	
C-3401	CILINDRO DE RODA ESQUERDA INFERIOR 25,40mm	GURGEL	X-20	<-	1977/1979	
C-3401	CILINDRO DE RODA ESQUERDA INFERIOR 25,40mm	VOLKSWAGEN	KOMBI	<-	1967/1982	
C-3402	CILINDRO DE RODA DIREITA INFERIOR 25,40mm	GURGEL	E-400	<-	1981/1983	
C-3402	CILINDRO DE RODA DIREITA INFERIOR 25,40mm	GURGEL	G-15	<-	1980/1981	
C-3402	CILINDRO DE RODA DIREITA INFERIOR 25,40mm	GURGEL	X-20	<-	1977/1979	
C-3402	CILINDRO DE RODA DIREITA INFERIOR 25,40mm	VOLKSWAGEN	KOMBI	<-	1967/1982	
C-3403	CILINDRO DE RODA 22,22mm	GURGEL	E-400	->	1981/1983	
C-3403	CILINDRO DE RODA 22,22mm	GURGEL	X-20	->	1977/1979	
C-3403	CILINDRO DE RODA 22,22mm	VOLKSWAGEN	KOMBI	->	1967/1975	
C-3404	CILINDRO DE RODA 17,46mm	FIAT	UNO	->	1987/1996	MOD. 1.5R/1.6R
C-3405	CILINDRO DE RODA ESQUERDA 20,63mm	GM - CHEVROLET	KADETT	->	1989/1998	SIST. ATE
C-3406	CILINDRO DE RODA DIREITA 20,63mm	GM - CHEVROLET	KADETT	->	1989/1998	SIST. ATE
C-3407	CILINDRO DE RODA 19,05mm	VOLKSWAGEN	FUSCA	->	1957/1976	C/ EIXO 5 FUSOS
C-3407	CILINDRO DE RODA 19,05mm	VOLKSWAGEN	KARMANN GHIA	->	1957/1969	
C-3408	CILINDRO DE RODA ESQUERDA 22,22mm	GM - CHEVROLET	IPANEMA	->	1990/1998	SIST. BOSCH
C-3408	CILINDRO DE RODA ESQUERDA 22,22mm	GM - CHEVROLET	MONZA	->	1988/1996	SIST. BOSCH
C-3409	CILINDRO DE RODA DIREITA 22,22mm	GM - CHEVROLET	IPANEMA	->	1990/1998	SIST. BOSCH
C-3409	CILINDRO DE RODA DIREITA 22,22mm	GM - CHEVROLET	MONZA	->	1988/1996	SIST. BOSCH
C-3410	CILINDRO DE RODA 19,05mm	DAEWOO	ESPERO	->	1993/1998	
C-3410	CILINDRO DE RODA 19,05mm	DAEWOO	LANOS	->	1997/2000	
C-3410	CILINDRO DE RODA 19,05mm	GM - CHEVROLET	AGILE	->	2010/...	
C-3410	CILINDRO DE RODA 19,05mm	GM - CHEVROLET	ASTRA	->	1995/2005	
C-3410	CILINDRO DE RODA 19,05mm	GM - CHEVROLET	CORSA	->	1994/2012	
C-3410	CILINDRO DE RODA 19,05mm	GM - CHEVROLET	CORSA CLASSIC	->	2003/...	
C-3410	CILINDRO DE RODA 19,05mm	GM - CHEVROLET	MERIVA	->	2003/2012	
C-3410	CILINDRO DE RODA 19,05mm	GM - CHEVROLET	TIGRA	->	1998/1999	
C-3410	CILINDRO DE RODA 19,05mm	GM - CHEVROLET	VECTRA	->	1997/2005	
C-3410	CILINDRO DE RODA 19,05mm	GM - CHEVROLET	VECTRA	->	2006/2011	S/ VÁLVULA PROPORCIONADORA
C-3410	CILINDRO DE RODA 19,05mm	GM - CHEVROLET	ZAFIRA	->	2002/2005	
C-3411	CILINDRO DE RODA 20,63mm	FIAT	BRAVA	->	2000/2003	
C-3411	CILINDRO DE RODA 20,63mm	FIAT	DOBLÒ	->	2002/ 2012	EXCETO ADVENTURE
C-3411	CILINDRO DE RODA 20,63mm	FIAT	FIORINO (mod. Uno)	->	1994/...	
C-3411	CILINDRO DE RODA 20,63mm	FIAT	IDEA	->	2006/...	
C-3411	CILINDRO DE RODA 20,63mm	FIAT	MAREA	->	2000/2007	
C-3411	CILINDRO DE RODA 20,63mm	FIAT	MAREA WEEKEND	->	2000/2007	
C-3411	CILINDRO DE RODA 20,63mm	FIAT	PALIO WEEKEND	->	1997/2008	EXCETO LOCKER
C-3411	CILINDRO DE RODA 20,63mm	FIAT	PALIO WEEKEND	->	2009/...	SIST. BOSCH
C-3411	CILINDRO DE RODA 20,63mm	FIAT	STILO	->	2003/2011	
C-3411	CILINDRO DE RODA 20,63mm	FIAT	STRADA	->	1999/2012	
C-3411	CILINDRO DE RODA 20,63mm	FIAT	TEMPRA	->	1992/1999	
C-3411	CILINDRO DE RODA 20,63mm	FIAT	UNO TURBO	->	1994/1996	
C-3412	CILINDRO DE RODA 19,05mm	FORD	ESCORT	->	1993/1996	SIST. VARGA
C-3412	CILINDRO DE RODA 19,05mm	FORD	FIESTA	->	1996/2002	MOTOR 1.4/1.6
C-3412	CILINDRO DE RODA 19,05mm	FORD	FIESTA STREET HATCH	->	2002/2007	MOTOR 1.6
C-3412	CILINDRO DE RODA 19,05mm	FORD	FIESTA STREET SEDAN	->	2002/2004	
C-3412	CILINDRO DE RODA 19,05mm	FORD	FOCUS	->	2003/2009	MOTOR 1.6 8V
C-3412	CILINDRO DE RODA 19,05mm	FORD	KA	->	2001/...	MOTOR 1.6
C-3412	CILINDRO DE RODA 19,05mm	FORD	VERONA	->	1994/1996	SIST. VARGA
C-3412	CILINDRO DE RODA 19,05mm	HYUNDAI	ACCENT	->	2000/2002	
C-3412	CILINDRO DE RODA 19,05mm	HYUNDAI	ELANTRA	->	2001/2004	
C-3412	CILINDRO DE RODA 19,05mm	HYUNDAI	MATRIX	->	2002/2004	
C-3412	CILINDRO DE RODA 19,05mm	HYUNDAI	SONATA	->	1999/2005	
C-3412	CILINDRO DE RODA 19,05mm	HYUNDAI	TERRACAN	->	2003/2006	
C-3412	CILINDRO DE RODA 19,05mm	KIA	SOUL	->	2009/...	
C-3412	CILINDRO DE RODA 19,05mm	VOLKSWAGEN	LOGUS	->	1993/1996	SIST. VARGA
C-3412	CILINDRO DE RODA 19,05mm	VOLKSWAGEN	POINTER	->	1994/1996	SIST. VARGA
C-3413	CILINDRO DE RODA 22,00mm	FIAT	TIPO	->	1993/1997	
C-3414	CILINDRO DE RODA ESQUERDA 20,63mm	GM - CHEVROLET	KADETT	->	1989/1998	SIST. BOSCH
C-3415	CILINDRO DE RODA DIREITA 20,63mm	GM - CHEVROLET	KADETT	->	1989/1998	SIST. BOSCH
C-3416	CILINDRO DE RODA 19,05mm	HONDA	CITY	->	2010/...	
C-3416	CILINDRO DE RODA 19,05mm	HONDA	FIT	->	2009/...	

Tabela de Conversão	Polegadas	9/16"	5/8"	11/16"	7/10"	3/4"	13/16"	7/8"	15/16"	1"	1 1/16"	1 1/8"	1 1/4"	1 3/8"	1 1/2"	1 5/8"	1 3/4"	1 27/32"	2"
	Milímetros	14,28mm	15,87mm	17,46mm	17,78mm	19,05mm	20,63mm	22,22mm	23,81mm	25,40mm	26,98mm	28,57mm	31,75mm	34,92mm	38,10mm	41,27mm	44,45mm	46,83mm	50,80mm

PEÇA	DESCRIÇÃO	MARCA	VEÍCULO		ANOS	SOMENTE PARA
C-3417	CILINDRO DE RODA ESQUERDA 23,81mm	GM - CHEVROLET	BLAZER	->	1996/2011	C/FREIO 280 X 63mm
C-3417	CILINDRO DE RODA ESQUERDA 23,81mm	GM - CHEVROLET	S-10	->	1995/2012	C/FREIO 280 X 63mm
C-3418	CILINDRO DE RODA DIREITA 23,81mm	GM - CHEVROLET	BLAZER	->	1996/2011	C/FREIO 280 X 63mm
C-3418	CILINDRO DE RODA DIREITA 23,81mm	GM - CHEVROLET	S-10	->	1995/2012	C/FREIO 280 X 63mm
C-3419	CILINDRO DE RODA ESQUERDA 28,57mm	GM - CHEVROLET	C-10/14/15/16	<-	1975/1978	
C-3419	CILINDRO DE RODA ESQUERDA 28,57mm	GM - CHEVROLET	VERANEIO	<-	1975/1978	
C-3420	CILINDRO DE RODA DIREITA 28,57mm	GM - CHEVROLET	C-10/14/15/16	<-	1975/1978	
C-3420	CILINDRO DE RODA DIREITA 28,57mm	GM - CHEVROLET	VERANEIO	<-	1975/1978	
C-3421	CILINDRO DE RODA ESQUERDA 28,57mm	GM - CHEVROLET	3100	<-	1964/1967	
C-3421	CILINDRO DE RODA ESQUERDA 28,57mm	GM - CHEVROLET	C-10/14/15/16	<-	1968/1975	
C-3421	CILINDRO DE RODA ESQUERDA 28,57mm	GM - CHEVROLET	VERANEIO	<-	1968/1975	
C-3422	CILINDRO DE RODA DIREITA 28,57mm	GM - CHEVROLET	3100	<-	1964/1967	
C-3422	CILINDRO DE RODA DIREITA 28,57mm	GM - CHEVROLET	C-10/14/15/16	<-	1968/1975	
C-3422	CILINDRO DE RODA DIREITA 28,57mm	GM - CHEVROLET	VERANEIO	<-	1968/1975	
C-3423	CILINDRO DE RODA 19,05mm	NISSAN	GRAND LIVINA	->	2010/...	
C-3423	CILINDRO DE RODA 19,05mm	NISSAN	SENTRA	->	2007/...	
C-3423	CILINDRO DE RODA 19,05mm	NISSAN	TIDA	->	2008/...	S/ABS
C-3424	CILINDRO DE RODA ESQUERDA 17,46mm	HYUNDAI	HR	->	2005/...	
C-3425	CILINDRO DE RODA DIREITA 17,46mm	HYUNDAI	HR	->	2005/...	
C-3426	CILINDRO DE RODA 19,05mm	GM - CHEVROLET	COBALT	->	2012/...	
C-3426	CILINDRO DE RODA 19,05mm	GM - CHEVROLET	ONIX	->	2012/...	
C-3426	CILINDRO DE RODA 19,05mm	GM - CHEVROLET	PRISMA	->	2013/...	
C-3426	CILINDRO DE RODA 19,05mm	GM - CHEVROLET	SONIC	->	2012/2014	
C-3427	CILINDRO DE RODA 19,05mm	FIAT	PALIO	->	2012/...	ATTRACTIVE 1.0 8V
C-3427	CILINDRO DE RODA 19,05mm	FIAT	PALIO	->	2012/...	ELX 1.0 8V
C-3427	CILINDRO DE RODA 19,05mm	FIAT	PALIO	->	2012/...	ESSENCE 1.6 16V
C-3427	CILINDRO DE RODA 19,05mm	FIAT	PALIO	->	2012/...	FIRE 1.0 8V
C-3427	CILINDRO DE RODA 19,05mm	FIAT	PALIO	->	2012/...	SPORTING 1.6 16V
C-3427	CILINDRO DE RODA 19,05mm	FIAT	PALIO WEEKEND	->	2012/...	ESSENCE 1.6 16V
C-3427	CILINDRO DE RODA 19,05mm	FIAT	PALIO WEEKEND	->	2012/...	TREKKING 1.6 16V
C-3427	CILINDRO DE RODA 19,05mm	FIAT	UNO	->	2012/...	CABRIO 1.4 8V
C-3427	CILINDRO DE RODA 19,05mm	FIAT	UNO	->	2012/...	ECONOMY 1.4 8V
C-3427	CILINDRO DE RODA 19,05mm	FIAT	UNO	->	2012/...	FIRE ECONOMY 1.0 8V
C-3427	CILINDRO DE RODA 19,05mm	FIAT	UNO	->	2012/...	FIRE SMART 1.0 8V
C-3427	CILINDRO DE RODA 19,05mm	FIAT	UNO	->	2012/...	FURGÃO 1.3 8V
C-3427	CILINDRO DE RODA 19,05mm	FIAT	UNO	->	2012/...	SPORTING 1.4 8V
C-3428	CILINDRO DE RODA 20,63mm	FIAT	PALIO	->	2012/...	ATTRACTIVE 1.4 8V
C-3428	CILINDRO DE RODA 20,63mm	FIAT	PALIO WAY	->	2012/...	FIRE 1.0
C-3428	CILINDRO DE RODA 20,63mm	FIAT	PALIO WEEKEND	->	2012/...	ADVENTURE 1.8
C-3428	CILINDRO DE RODA 20,63mm	FIAT	PALIO WEEKEND	->	2012/...	ATTRACTIVE 1.4
C-3428	CILINDRO DE RODA 20,63mm	FIAT	UNO	->	2012/...	ATTRACTIVE 1.4 8V
C-3428	CILINDRO DE RODA 20,63mm	FIAT	UNO WAY	->	2012/...	1.0 8V
C-3428	CILINDRO DE RODA 20,63mm	FIAT	UNO VIVACE	->	2012/...	1.0 8V
C-3429	CILINDRO DE RODA 22,22mm	FIAT	PALIO	->	2012/...	1.0 COM ABS
C-3429	CILINDRO DE RODA 22,22mm	FIAT	PALIO	->	2012/...	1.6 16V
C-3429	CILINDRO DE RODA 22,22mm	FIAT	PALIO	->	2012/...	1.4
C-3431	CILINDRO DE RODA 19,05mm	RENAULT	DUSTER	->	2012/...	4x2
C-3435	CILINDRO DE RODA ESQUERDA 19,05mm	FORD	ESCORT	->	1993/1996	SIST. BOSCH
C-3435	CILINDRO DE RODA ESQUERDA 19,05mm	FORD	VERONA	->	1994/1996	SIST. BOSCH
C-3435	CILINDRO DE RODA ESQUERDA 19,05mm	VOLKSWAGEN	LOGUS	->	1993/1996	SIST. BOSCH
C-3435	CILINDRO DE RODA ESQUERDA 19,05mm	VOLKSWAGEN	POINTER	->	1994/1996	SIST. BOSCH
C-3436	CILINDRO DE RODA DIREITA 19,05mm	FORD	ESCORT	->	1993/1996	SIST. BOSCH
C-3436	CILINDRO DE RODA DIREITA 19,05mm	FORD	VERONA	->	1994/1996	SIST. BOSCH
C-3436	CILINDRO DE RODA DIREITA 19,05mm	VOLKSWAGEN	LOGUS	->	1993/1996	SIST. BOSCH
C-3436	CILINDRO DE RODA DIREITA 19,05mm	VOLKSWAGEN	POINTER	->	1994/1996	SIST. BOSCH
C-3437	CILINDRO DE RODA 19,05mm	FIAT	PALIO	->	1996/1998	
C-3437	CILINDRO DE RODA 19,05mm	FIAT	SIENA	->	1998/1998	
C-3438	CILINDRO DE RODA 19,00mm	FORD	FIESTA	->	1995/1995	
C-3439	CILINDRO DE RODA 17,78mm	FORD	ESCORT	->	1983/1992	
C-3439	CILINDRO DE RODA 17,78mm	FORD	ESCORT HOBBY	->	1993/1996	
C-3439	CILINDRO DE RODA 17,78mm	FORD	FIESTA	->	1996/2002	MOTOR 1.0/1.3
C-3439	CILINDRO DE RODA 17,78mm	FORD	FIESTA STREET HATCH	->	2001/2007	MOTOR 1.0

Tabela de Conversão	Polegadas	9/16"	5/8"	11/16"	7/10"	3/4"	13/16"	7/8"	15/16"	1"	1 1/16"	1 1/8"	1 1/4"	1 3/8"	1 1/2"	1 5/8"	1 3/4"	1 27/32"	2"
	Milímetros	14,28mm	15,87mm	17,46mm	17,78mm	19,05mm	20,63mm	22,22mm	23,81mm	25,40mm	26,98mm	28,57mm	31,75mm	34,92mm	38,10mm	41,27mm	44,45mm	46,83mm	50,80mm

PEÇA	DESCRIÇÃO	MARCA	VEÍCULO		ANOS	SOMENTE PARA
C-3439	CILINDRO DE RODA 17,78mm	FORD	KA	->	1997/...	MOTOR 1.0/1.3
C-3439	CILINDRO DE RODA 17,78mm	FORD	VERONA	->	1990/1992	
C-3439	CILINDRO DE RODA 17,78mm	GM - CHEVROLET	CELTA	->	2001/2002	
C-3439	CILINDRO DE RODA 17,78mm	HYUNDAI	ATOS PRIME	->	2000/2003	
C-3439	CILINDRO DE RODA 17,78mm	KIA	CERATO	->	2006/2008	
C-3439	CILINDRO DE RODA 17,78mm	VOLKSWAGEN	APOLLO	->	1990/1992	
C-3440	CILINDRO DE RODA 19,05mm	SEAT	CORDOBA	->	1995/2002	
C-3440	CILINDRO DE RODA 19,05mm	SEAT	CORDOBA VARIO	->	2000/2002	
C-3440	CILINDRO DE RODA 19,05mm	SEAT	IBIZA	->	1995/2002	
C-3440	CILINDRO DE RODA 19,05mm	VOLKSWAGEN	GOL (G2)	->	1998/2000	C/ABS
C-3440	CILINDRO DE RODA 19,05mm	VOLKSWAGEN	GOL (G3)	->	2000/2005	C/ABS
C-3440	CILINDRO DE RODA 19,05mm	VOLKSWAGEN	GOLF	->	1995/1998	MOD. GLX
C-3440	CILINDRO DE RODA 19,05mm	VOLKSWAGEN	GOLF	->	1995/1998	MOD. GL (fabr. Alemanha)
C-3440	CILINDRO DE RODA 19,05mm	VOLKSWAGEN	PARATI (G2, G3 e G4)	->	1996/2000	S/ABS
C-3440	CILINDRO DE RODA 19,05mm	VOLKSWAGEN	PARATI (G2, G3 e G4)	->	1998/2012	C/ABS
C-3440	CILINDRO DE RODA 19,05mm	VOLKSWAGEN	POLO CLASSIC	->	1997/2002	
C-3440	CILINDRO DE RODA 19,05mm	VOLKSWAGEN	SAVEIRO (G1)	->	1982/1986	
C-3440	CILINDRO DE RODA 19,05mm	VOLKSWAGEN	SAVEIRO (G2, G3 e G4)	->	1998/1998	
C-3440	CILINDRO DE RODA 19,05mm	VOLKSWAGEN	SAVEIRO (G2, G3 e G4)	->	2000/2009	C/ABS
C-3440	CILINDRO DE RODA 19,05mm	VOLKSWAGEN	SAVEIRO (G5)	->	2010/...	1KN
C-3440	CILINDRO DE RODA 19,05mm	VOLKSWAGEN	SPACEFOX	->	2006/...	
C-3440	CILINDRO DE RODA 19,05mm	VOLKSWAGEN	SPACE CROSS	->	2012/...	
C-3441	CILINDRO DE RODA ESQUERDA 23,81mm	GM - CHEVROLET	A-20	->	1993/1996	
C-3441	CILINDRO DE RODA ESQUERDA 23,81mm	GM - CHEVROLET	BONANZA	->	1993/1996	
C-3441	CILINDRO DE RODA ESQUERDA 23,81mm	GM - CHEVROLET	C-20	->	1993/1996	
C-3441	CILINDRO DE RODA ESQUERDA 23,81mm	GM - CHEVROLET	D-20	->	1993/1996	
C-3441	CILINDRO DE RODA ESQUERDA 23,81mm	GM - CHEVROLET	GRAND BLAZER	->	1998/1999	
C-3441	CILINDRO DE RODA ESQUERDA 23,81mm	GM - CHEVROLET	SILVERADO	->	1997/1999	
C-3441	CILINDRO DE RODA ESQUERDA 23,81mm	GM - CHEVROLET	VERANEIO	->	1993/1996	
C-3441	CILINDRO DE RODA ESQUERDA 23,81mm	GMC	3500 HD	->	1997/1999	
C-3442	CILINDRO DE RODA DIREITA 23,81mm	GM - CHEVROLET	A-20	->	1993/1996	
C-3442	CILINDRO DE RODA DIREITA 23,81mm	GM - CHEVROLET	BONANZA	->	1993/1996	
C-3442	CILINDRO DE RODA DIREITA 23,81mm	GM - CHEVROLET	C-20	->	1993/1996	
C-3442	CILINDRO DE RODA DIREITA 23,81mm	GM - CHEVROLET	D-20	->	1993/1996	
C-3442	CILINDRO DE RODA DIREITA 23,81mm	GM - CHEVROLET	GRAND BLAZER	->	1998/1999	
C-3442	CILINDRO DE RODA DIREITA 23,81mm	GM - CHEVROLET	SILVERADO	->	1997/1999	
C-3442	CILINDRO DE RODA DIREITA 23,81mm	GM - CHEVROLET	VERANEIO	->	1993/1996	
C-3442	CILINDRO DE RODA DIREITA 23,81mm	GMC	3500 HD	->	1997/1999	
C-3443	CILINDRO DE RODA 22,22mm	MITSUBISHI	PAJERO TR4	->	2003/...	
C-3444	CILINDRO DE RODA ESQUERDA 22,22mm	GM - CHEVROLET	A-10	->	1985/1989	
C-3444	CILINDRO DE RODA ESQUERDA 22,22mm	GM - CHEVROLET	A-20	->	1985/1992	
C-3444	CILINDRO DE RODA ESQUERDA 22,22mm	GM - CHEVROLET	BONANZA	->	1990/1992	
C-3444	CILINDRO DE RODA ESQUERDA 22,22mm	GM - CHEVROLET	C-10/14/15/16	->	1979/1989	
C-3444	CILINDRO DE RODA ESQUERDA 22,22mm	GM - CHEVROLET	C-20	->	1985/1992	
C-3445	CILINDRO DE RODA DIREITA 22,22mm	GM - CHEVROLET	A-10	->	1985/1989	
C-3445	CILINDRO DE RODA DIREITA 22,22mm	GM - CHEVROLET	A-20	->	1985/1992	
C-3445	CILINDRO DE RODA DIREITA 22,22mm	GM - CHEVROLET	BONANZA	->	1990/1992	
C-3445	CILINDRO DE RODA DIREITA 22,22mm	GM - CHEVROLET	C-10/14/15/16	->	1979/1989	
C-3445	CILINDRO DE RODA DIREITA 22,22mm	GM - CHEVROLET	C-20	->	1985/1992	
C-3446	CILINDRO DE RODA ESQUERDA 22,22mm	GM - CHEVROLET	CARAVAN	->	1981/1982	SIST. BENDIX
C-3446	CILINDRO DE RODA ESQUERDA 22,22mm	GM - CHEVROLET	OPALA	->	1981/1982	SIST. BENDIX
C-3447	CILINDRO DE RODA DIREITA 22,22mm	GM - CHEVROLET	CARAVAN	->	1981/1982	SIST. BENDIX
C-3447	CILINDRO DE RODA DIREITA 22,22mm	GM - CHEVROLET	OPALA	->	1981/1982	SIST. BENDIX
C-3448	CILINDRO DE RODA ESQUERDA 17,46mm	KIA	BESTA	->	1993/1998	MOD. 2.2/2.7
C-3448	CILINDRO DE RODA ESQUERDA 17,46mm	KIA	BONGO	->	1993/1997	K-2400
C-3449	CILINDRO DE RODA DIREITA 17,46mm	KIA	BESTA	->	1993/1998	MOD. 2.2/2.7
C-3449	CILINDRO DE RODA DIREITA 17,46mm	KIA	BONGO	->	1993/1997	K-2400
C-3450	CILINDRO DE RODA ESQUERDA 17,46mm	ASIA	TOWNER	->	1993/1999	
C-3451	CILINDRO DE RODA DIREITA 17,46mm	ASIA	TOWNER	->	1993/1999	
C-3452	CILINDRO DE RODA ESQUERDA 19,05mm	ASIA	ROCSTA	->	1994/1995	
C-3452	CILINDRO DE RODA ESQUERDA 19,05mm	ASIA	TOPIC	->	1993/1999	
C-3453	CILINDRO DE RODA DIREITA 19,05mm	ASIA	ROCSTA	->	1994/1995	

Tabela de Conversão	Polegadas	9/16"	5/8"	11/16"	7/10"	3/4"	13/16"	7/8"	15/16"	1"	1 1/16"	1 1/8"	1 1/4"	1 3/8"	1 1/2"	1 5/8"	1 3/4"	1 27/32"	2"
	Milímetros		14,28mm	15,87mm	17,46mm	17,78mm	19,05mm	20,63mm	22,22mm	23,81mm	25,40mm	26,98mm	28,57mm	31,75mm	34,92mm	38,10mm	41,27mm	44,45mm	46,83mm

PEÇA	DESCRIÇÃO	MARCA	VEÍCULO		ANOS	SOMENTE PARA
C-3453	CILINDRO DE RODA DIREITA 19,05mm	ASIA	TOPIC	->	1993/1999	
C-3454	CILINDRO DE RODA 25,40mm	MERCEDES BENZ	MB-180	->	1994/1996	
C-3455	CILINDRO DE RODA 22,22mm	MITSUBISHI	L200 TRITON	->	2008/...	
C-3456	CILINDRO DE RODA ESQUERDA 22,22mm	GM - CHEVROLET	BLAZER	->	1997/2011	C/FREIO 280 X 51mm
C-3456	CILINDRO DE RODA ESQUERDA 22,22mm	GM - CHEVROLET	S-10	->	1997/2012	C/FREIO 280 X 51mm
C-3457	CILINDRO DE RODA DIREITA 22,22mm	GM - CHEVROLET	BLAZER	->	1997/2011	C/FREIO 280 X 51mm
C-3457	CILINDRO DE RODA DIREITA 22,22mm	GM - CHEVROLET	S-10	->	1997/2012	C/FREIO 280 X 51mm
C-3458	CILINDRO DE RODA ESQUERDA 20,63mm	FORD	PAMPA	->	1983/1995	C/ TRACÇÃO 4X4
C-3459	CILINDRO DE RODA DIREITA 20,63mm	FORD	PAMPA	->	1983/1995	C/ TRACÇÃO 4X4
C-3460	CILINDRO DE RODA ESQUERDA 22,22mm	FORD	AERO/ITAMARATY	->	1963/1971	
C-3460	CILINDRO DE RODA ESQUERDA 22,22mm	FORD	F-100	->	1968/1987	
C-3461	CILINDRO DE RODA DIREITA 22,22mm	FORD	AERO/ITAMARATY	->	1963/1971	
C-3461	CILINDRO DE RODA DIREITA 22,22mm	FORD	F-100	->	1968/1987	
C-3462	CILINDRO DE RODA 20,63mm	FORD	ESCORT	->	1997/2003	
C-3462	CILINDRO DE RODA 20,63mm	FORD	ESCORT SW	->	1997/2003	
C-3462	CILINDRO DE RODA 20,63mm	FORD	FOCUS	->	2001/2005	MOTOR 1.8/2.0 16V
C-3463	CILINDRO DE RODA 23,81mm	GM - CHEVROLET	SPACE VAN	->	1997/1999	
C-3463	CILINDRO DE RODA 23,81mm	GM - CHEVROLET	TRAFIC	->	1992/1998	
C-3463	CILINDRO DE RODA 23,81mm	RENAULT	TRAFIC	->	1992/2003	
C-3464	CILINDRO DE RODA ESQUERDA 22,00mm	RENAULT	19	->	1992/1998	MOD. RN/RT SIST. VARGA
C-3464	CILINDRO DE RODA ESQUERDA 22,00mm	RENAULT	CLIO	->	1996/1999	
C-3465	CILINDRO DE RODA DIREITA 22,00mm	RENAULT	19	->	1992/1998	MOD. RN/RT SIST. VARGA
C-3465	CILINDRO DE RODA DIREITA 22,00mm	RENAULT	CLIO	->	1996/1999	
C-3466	CILINDRO DE RODA ESQUERDA 20,63mm	FORD	RANGER	->	2005/2012	
C-3466	CILINDRO DE RODA ESQUERDA 20,63mm	MERCEDES BENZ	SPRINTER	->	1997/2000	
C-3467	CILINDRO DE RODA DIREITA 20,63mm	FORD	RANGER	->	2005/2012	
C-3467	CILINDRO DE RODA DIREITA 20,63mm	MERCEDES BENZ	SPRINTER	->	1997/2000	
C-3468	CILINDRO DE RODA ESQUERDA 19,05mm	GM - CHEVROLET	CARAVAN	->	1979/1980	
C-3468	CILINDRO DE RODA ESQUERDA 19,05mm	GM - CHEVROLET	OPALA	->	1979/1980	
C-3468	CILINDRO DE RODA ESQUERDA 19,05mm	PUMA	GTB	->	1979/1980	
C-3469	CILINDRO DE RODA DIREITA 19,05mm	GM - CHEVROLET	CARAVAN	->	1979/1980	
C-3469	CILINDRO DE RODA DIREITA 19,05mm	GM - CHEVROLET	OPALA	->	1979/1980	
C-3469	CILINDRO DE RODA DIREITA 19,05mm	PUMA	GTB	->	1979/1980	
C-3470	CILINDRO DE RODA 22,22mm	FORD	COURIER	->	1998/...	
C-3470	CILINDRO DE RODA 22,22mm	FORD	ECOSPORT	->	2004/2012	4X4
C-3470	CILINDRO DE RODA 22,22mm	FORD	MONDEO SW	->	1994/2001	
C-3471	CILINDRO DE RODA 20,63mm	VOLKSWAGEN	PARATI (G2, G3 e G4)	->	2001/2012	S/ABS
C-3471	CILINDRO DE RODA 20,63mm	VOLKSWAGEN	SAVEIRO (G2, G3 e G4)	->	1998/2009	
C-3472	CILINDRO DE RODA 19,05mm	FIAT	PALIO	->	1999/2011	S/ABS
C-3472	CILINDRO DE RODA 19,05mm	FIAT	PALIO	->	2012/...	MOD. FIRE S/ABS
C-3472	CILINDRO DE RODA 19,05mm	FIAT	SIENA	->	1999/2000	S/ABS
C-3472	CILINDRO DE RODA 19,05mm	FIAT	SIENA	->	2001/...	MOTOR 1.0/1.3 S/ABS
C-3472	CILINDRO DE RODA 19,05mm	FIAT	UNO	->	2008/2010	
C-3472	CILINDRO DE RODA 19,05mm	FIAT	UNO	->	2011/...	MILLE/FURGÃO
C-3472	CILINDRO DE RODA 19,05mm	FORD	ECOSPORT	->	2006/2012	4X2 C/ABS
C-3472	CILINDRO DE RODA 19,05mm	FORD	FIESTA	->	2003/2006	MOTOR 1.0
C-3472	CILINDRO DE RODA 19,05mm	FORD	FIESTA	->	2007/...	
C-3472	CILINDRO DE RODA 19,05mm	FORD	FIESTA SEDAN	->	2007/...	
C-3473	CILINDRO DE RODA 17,46mm	RENAULT	MEGANE	->	1997/2005	
C-3474	CILINDRO DE RODA ESQUERDA 19,00mm	RENAULT	19	->	1992/1998	MOD. RT SIST. BENDIX 8"
C-3475	CILINDRO DE RODA DIREITA 19,00mm	RENAULT	19	->	1992/1998	MOD. RT SIST. BENDIX 8"
C-3476	CILINDRO DE RODA ESQUERDA 22,22mm	RENAULT	21	->	1992/1994	SIST. LUCAS
C-3476	CILINDRO DE RODA ESQUERDA 22,22mm	RENAULT	21 NEVADA	->	1993/1994	SIST. LUCAS
C-3477	CILINDRO DE RODA DIREITA 22,22mm	RENAULT	21	->	1992/1994	SIST. LUCAS
C-3477	CILINDRO DE RODA DIREITA 22,22mm	RENAULT	21 NEVADA	->	1993/1994	SIST. LUCAS
C-3478	CILINDRO DE RODA 20,63mm	CITROËN	XSARA	->	1998/2003	SIST. LUCAS C/ABS
C-3478	CILINDRO DE RODA 20,63mm	CITROËN	ZX	->	1995/1998	C/ABS
C-3478	CILINDRO DE RODA 20,63mm	FIAT	GRAND SIENA	->	2012/...	
C-3478	CILINDRO DE RODA 20,63mm	FIAT	PALIO	->	2012/...	SIST. TRW
C-3478	CILINDRO DE RODA 20,63mm	FIAT	PALIO WEEKEND	->	2009/...	SIST. TRW
C-3478	CILINDRO DE RODA 20,63mm	FIAT	PUNTO	->	2008/...	
C-3478	CILINDRO DE RODA 20,63mm	PEUGEOT	106	->	1997/1998	C/ABS

Tabela de Conversão	Polegadas	9/16"	5/8"	11/16"	7/10"	3/4"	13/16"	7/8"	15/16"	1"	1 1/16"	1 1/8"	1 1/4"	1 3/8"	1 1/2"	1 5/8"	1 3/4"	1 27/32"	2"
	Milímetros	14,28mm	15,87mm	17,46mm	17,78mm	19,05mm	20,63mm	22,22mm	23,81mm	25,40mm	26,98mm	28,57mm	31,75mm	34,92mm	38,10mm	41,27mm	44,45mm	46,83mm	50,80mm

PEÇA	DESCRIÇÃO	MARCA	VEÍCULO		ANOS	SOMENTE PARA
C-3478	CILINDRO DE RODA 20,63mm	PEUGEOT	306	->	1994/2002	SIST. LUCAS C/ABS
C-3478	CILINDRO DE RODA 20,63mm	RENAULT	LAGUNA	->	1999/2001	
C-3478	CILINDRO DE RODA 20,63mm	RENAULT	LAGUNA NEVADA	->	1995/1998	
C-3478	CILINDRO DE RODA 20,63mm	RENAULT	SCENIC	->	1999/2011	
C-3479	CILINDRO DE RODA 22,22mm	PEUGEOT	504 PICK-UP	->	1992/1999	SIST. GIRLING
C-3479	CILINDRO DE RODA 22,22mm	RENAULT	EXPRESS	->	1998/2000	
C-3480	CILINDRO DE RODA 20,63mm	AUDI	80	->	1993/1994	MOTOR 2.0 8V S/ABS
C-3480	CILINDRO DE RODA 20,63mm	AUDI	80 AVANT	->	1993/1994	MOTOR 2.0 8V S/ABS
C-3480	CILINDRO DE RODA 20,63mm	SEAT	INCA	->	1999/2002	
C-3480	CILINDRO DE RODA 20,63mm	VOLKSWAGEN	SAVEIRO (G5)	->	2010/...	1KM
C-3480	CILINDRO DE RODA 20,63mm	VOLKSWAGEN	VAN	->	1999/2002	
C-3481	CILINDRO DE RODA ESQUERDA 19,05mm	HONDA	ACCORD	->	1991/1993	
C-3481	CILINDRO DE RODA ESQUERDA 19,05mm	HONDA	CIVIC	->	1992/2000	
C-3482	CILINDRO DE RODA DIREITA 19,05mm	HONDA	ACCORD	->	1991/1993	
C-3482	CILINDRO DE RODA DIREITA 19,05mm	HONDA	CIVIC	->	1992/2000	
C-3483	CILINDRO DE RODA 23,81mm	TOYOTA	HILUX SW4	->	1996/2000	C/ ARO 15"
C-3484	CILINDRO DE RODA ESQUERDA 17,46mm	TOYOTA	COROLLA	->	1992/1998	
C-3484	CILINDRO DE RODA ESQUERDA 17,46mm	TOYOTA	PASEO	->	1992/1995	
C-3485	CILINDRO DE RODA DIREITA 17,46mm	TOYOTA	COROLLA	->	1992/1998	
C-3485	CILINDRO DE RODA DIREITA 17,46mm	TOYOTA	PASEO	->	1992/1995	
C-3486	CILINDRO DE RODA 26,98mm	CITROËN	JUMPER	->	1996/2002	
C-3486	CILINDRO DE RODA 26,98mm	FIAT	DUCATO	->	1998/1998	10/15 LUGARES
C-3486	CILINDRO DE RODA 26,98mm	FIAT	DUCATO	->	1999/2002	15/COMBINATO/MINIBUS
C-3486	CILINDRO DE RODA 26,98mm	PEUGEOT	BOXER	->	1998/2002	
C-3489	CILINDRO DE RODA 20,63mm	FORD	MONDEO	->	1994/2001	C/ FREIO 9"
C-3490	CILINDRO DE RODA 17,78mm	RENAULT	CLIO	->	2000/2009	
C-3491	CILINDRO DE RODA 22,22mm	TOYOTA	HILUX PICK-UP	->	1992/2005	4X4
C-3491	CILINDRO DE RODA 22,22mm	TOYOTA	HILUX SW4	->	1992/1995	
C-3492	CILINDRO DE RODA ESQUERDA 28,57mm	GM - CHEVROLET	GRAND BLAZER	->	1999/2000	
C-3492	CILINDRO DE RODA ESQUERDA 28,57mm	GM - CHEVROLET	SILVERADO	->	1999/2001	
C-3492	CILINDRO DE RODA ESQUERDA 28,57mm	GMC	3500 HD	->	1999/2002	
C-3493	CILINDRO DE RODA DIREITA 28,57mm	GM - CHEVROLET	GRAND BLAZER	->	1999/2000	
C-3493	CILINDRO DE RODA DIREITA 28,57mm	GM - CHEVROLET	SILVERADO	->	1999/2001	
C-3493	CILINDRO DE RODA DIREITA 28,57mm	GMC	3500 HD	->	1999/2002	
C-3494	CILINDRO DE RODA ESQUERDA 28,57mm	FORD	F-250	->	1999/2012	
C-3494	CILINDRO DE RODA ESQUERDA 28,57mm	FORD - CAMINHÕES	F-350	->	1999/2012	
C-3495	CILINDRO DE RODA DIREITA 28,57mm	FORD	F-250	->	1999/2012	
C-3495	CILINDRO DE RODA DIREITA 28,57mm	FORD - CAMINHÕES	F-350	->	1999/2012	
C-3496	CILINDRO DE RODA 20,63mm	CITROËN	C3	->	2013/...	(NOVO)
C-3496	CILINDRO DE RODA 20,63mm	FIAT	PALIO	->	1999/2011	C/ABS
C-3496	CILINDRO DE RODA 20,63mm	FIAT	PALIO	->	2012/...	MOD. FIRE C/ABS
C-3496	CILINDRO DE RODA 20,63mm	FIAT	SIENA	->	1999/2000	C/ABS
C-3496	CILINDRO DE RODA 20,63mm	FIAT	SIENA	->	2001/...	MOTOR 1.6/1.8
C-3496	CILINDRO DE RODA 20,63mm	FIAT	SIENA	->	2001/...	MOTOR 1.0/1.3 C/ABS
C-3496	CILINDRO DE RODA 20,63mm	FIAT	UNO	->	2011/...	S/ABS COM 1 FURO DE FIXAÇÃO
C-3496	CILINDRO DE RODA 20,63mm	FORD	ECOSPORT	->	2003/2012	4X2 S/ABS
C-3496	CILINDRO DE RODA 20,63mm	FORD	FIESTA	->	2003/2006	MOTOR 1.6/1.0 SUPERCHARGER
C-3496	CILINDRO DE RODA 20,63mm	FORD	FIESTA SEDAN	->	2005/2006	
C-3497	CILINDRO DE RODA 20,63mm	FORD	RANGER	->	1998/2005	C/ FREIO 11"
C-3498	CILINDRO DE RODA ESQUERDA 22,22mm	MITSUBISHI	L200	->	1992/2006	L/GL/GLS 4X4
C-3498	CILINDRO DE RODA ESQUERDA 22,22mm	MITSUBISHI	PAJERO	->	1994/1997	MOTOR 2.8 DIESEL 4X4
C-3499	CILINDRO DE RODA DIREITA 22,22mm	MITSUBISHI	L200	->	1992/2006	L/GL/GLS 4X4
C-3499	CILINDRO DE RODA DIREITA 22,22mm	MITSUBISHI	PAJERO	->	1994/1997	MOTOR 2.8 DIESEL 4X4
C-3500	CILINDRO DE RODA 14,28mm	GM - CHEVROLET	CELTA	->	2003/...	
C-3500	CILINDRO DE RODA 14,28mm	GM - CHEVROLET	PRISMA	->	2007/2012	
C-3501	CILINDRO DE RODA 17,78mm	MERCEDES BENZ	CLASSE A	->	1999/2005	
C-3502	CILINDRO DE RODA ESQUERDA 19,05mm	TOYOTA	COROLLA	->	1998/2002	
C-3503	CILINDRO DE RODA DIREITA 19,05mm	TOYOTA	COROLLA	->	1998/2002	
C-3504	CILINDRO DE RODA 20,63mm	FORD	RANGER	->	1998/2001	C/ FREIO 10"
C-3505	CILINDRO DE RODA 22,22mm	CITROËN	BERLINGO	->	1998/2007	
C-3505	CILINDRO DE RODA 22,22mm	CITROËN	XSARA PICASSO	->	2001/2012	
C-3505	CILINDRO DE RODA 22,22mm	PEUGEOT	HOGGAR	->	2010/...	

Tabela de Conversão	Polegadas	9/16"	5/8"	11/16"	7/10"	3/4"	13/16"	7/8"	15/16"	1"	1 1/16"	1 1/8"	1 1/4"	1 3/8"	1 1/2"	1 5/8"	1 3/4"	1 27/32"	2"
	Milímetros	14,28mm	15,87mm	17,46mm	17,78mm	19,05mm	20,63mm	22,22mm	23,81mm	25,40mm	26,98mm	28,57mm	31,75mm	34,92mm	38,10mm	41,27mm	44,45mm	46,83mm	50,80mm



PEÇA	DESCRIÇÃO	MARCA	VEÍCULO		ANOS	SOMENTE PARA
C-3505	CILINDRO DE RODA 22,22mm	PEUGEOT	PARTNER	->	1999/...	
C-3506	CILINDRO DE RODA 20,63mm	KIA	SPORTAGE	->	1997/2004	
C-3507	CILINDRO DE RODA 19,05mm	HYUNDAI	H-100	->	1995/1999	
C-3507	CILINDRO DE RODA 19,05mm	HYUNDAI	PORTER	->	2000/2003	
C-3508	CILINDRO DE RODA 20,63mm	HYUNDAI	H-100	->	2000/2004	
C-3509	CILINDRO DE RODA AUTOAJUSTÁVEL 19,05mm	FIAT	DUNA	->	1994/1996	
C-3510	CILINDRO DE RODA 28,57mm	FIAT	DUCATO	->	1998/1998	8-Oct
C-3510	CILINDRO DE RODA 28,57mm	FIAT	DUCATO	->	1999/2002	MAXI
C-3511	CILINDRO DE RODA ESQ. 20,63mm C/ VÁLV. REG.	CITROËN	XSARA	->	1998/2003	SIST. BENDIX S/ABS
C-3511	CILINDRO DE RODA ESQ. 20,63mm C/ VÁLV. REG.	CITROËN	ZX	->	1992/1998	SIST. BENDIX S/ABS
C-3511	CILINDRO DE RODA ESQ. 20,63mm C/ VÁLV. REG.	PEUGEOT	206	->	1999/2010	
C-3511	CILINDRO DE RODA ESQ. 20,63mm C/ VÁLV. REG.	PEUGEOT	207	->	2009/...	
C-3511	CILINDRO DE RODA ESQ. 20,63mm C/ VÁLV. REG.	PEUGEOT	306	->	1994/2002	SIST. BENDIX S/ABS
C-3511	CILINDRO DE RODA ESQ. 20,63mm C/ VÁLV. REG.	RENAULT	19	->	1992/1998	MOD. RN SIST. BENDIX 7"
C-3512	CILINDRO DE RODA DIR. 20,63mm C/ VÁLV. REG.	CITROËN	XSARA	->	1998/2003	SIST. BENDIX S/ABS
C-3512	CILINDRO DE RODA DIR. 20,63mm C/ VÁLV. REG.	CITROËN	ZX	->	1992/1998	SIST. BENDIX S/ABS
C-3512	CILINDRO DE RODA DIR. 20,63mm C/ VÁLV. REG.	PEUGEOT	206	->	1999/2010	
C-3512	CILINDRO DE RODA DIR. 20,63mm C/ VÁLV. REG.	PEUGEOT	207	->	2009/...	
C-3512	CILINDRO DE RODA DIR. 20,63mm C/ VÁLV. REG.	PEUGEOT	306	->	1994/2002	SIST. BENDIX S/ABS
C-3512	CILINDRO DE RODA DIR. 20,63mm C/ VÁLV. REG.	RENAULT	19	->	1992/1998	MOD. RN SIST. BENDIX 7"
C-3513	CILINDRO DE RODA ESQUERDA 19,05mm	HONDA	CIVIC	->	2001/2006	
C-3514	CILINDRO DE RODA DIREITA 19,05mm	HONDA	CIVIC	->	2001/2006	
C-3515	CILINDRO DE RODA ESQUERDA 19,05mm	HYUNDAI	ACCENT	->	1995/1999	
C-3515	CILINDRO DE RODA ESQUERDA 19,05mm	HYUNDAI	COUPE	->	1997/2001	
C-3515	CILINDRO DE RODA ESQUERDA 19,05mm	HYUNDAI	ELANTRA	->	1992/2000	
C-3515	CILINDRO DE RODA ESQUERDA 19,05mm	HYUNDAI	SONATA	->	1994/1998	
C-3516	CILINDRO DE RODA DIREITA 19,05mm	HYUNDAI	ACCENT	->	1995/1999	
C-3516	CILINDRO DE RODA DIREITA 19,05mm	HYUNDAI	COUPE	->	1997/2001	
C-3516	CILINDRO DE RODA DIREITA 19,05mm	HYUNDAI	ELANTRA	->	1992/2000	
C-3516	CILINDRO DE RODA DIREITA 19,05mm	HYUNDAI	SONATA	->	1994/1998	
C-3517	CILINDRO DE RODA 25,40mm	TOYOTA	HILUX SW4	->	2000/2005	C/ ARO 16"
C-3518	CILINDRO DE RODA 22,22mm	FORD	MONDEO	->	1994/1996	C/ FREIO 8"
C-3519	CILINDRO DE RODA 19,05mm	PEUGEOT	106	->	1994/1996	C/ABS
C-3519	CILINDRO DE RODA 19,05mm	PEUGEOT	206 SW	->	2005/2008	SIST. BOSCH
C-3519	CILINDRO DE RODA 19,05mm	PEUGEOT	207 SW	->	2009/...	SIST. BOSCH
C-3520	CILINDRO DE RODA 17,46mm	HONDA	FIT	->	2003/2008	
C-3521	CILINDRO DE RODA 22,22mm	GM - CHEVROLET	ASTRA	->	2005/2011	
C-3521	CILINDRO DE RODA 22,22mm	GM - CHEVROLET	MONTANA	->	2004/...	
C-3521	CILINDRO DE RODA 22,22mm	GM - CHEVROLET	VECTRA	->	2006/2011	C/ VÁLVULA PROPORCIONADORA
C-3521	CILINDRO DE RODA 22,22mm	GM - CHEVROLET	ZAFIRA	->	2005/2012	
C-3522	CILINDRO DE RODA ESQ. 20,63mm C/ VÁLV. REG.	CITROËN	XSARA	->	1998/2003	SIST. LUCAS S/ABS
C-3522	CILINDRO DE RODA ESQ. 20,63mm C/ VÁLV. REG.	CITROËN	ZX	->	1992/1998	SIST. LUCAS S/ABS
C-3522	CILINDRO DE RODA ESQ. 20,63mm C/ VÁLV. REG.	PEUGEOT	306	->	1994/2002	SIST. LUCAS S/ABS
C-3522	CILINDRO DE RODA ESQ. 20,63mm C/ VÁLV. REG.	RENAULT	19	->	1992/1998	MOD. RN SIST. LUCAS
C-3523	CILINDRO DE RODA DIR. 20,63mm C/ VÁLV. REG.	CITROËN	XSARA	->	1998/2003	SIST. LUCAS S/ABS
C-3523	CILINDRO DE RODA DIR. 20,63mm C/ VÁLV. REG.	CITROËN	ZX	->	1992/1998	SIST. LUCAS S/ABS
C-3523	CILINDRO DE RODA DIR. 20,63mm C/ VÁLV. REG.	PEUGEOT	306	->	1994/2002	SIST. LUCAS S/ABS
C-3523	CILINDRO DE RODA DIR. 20,63mm C/ VÁLV. REG.	RENAULT	19	->	1992/1998	MOD. RN SIST. LUCAS
C-3524	CILINDRO DE RODA ESQ. 19,05mm C/ VÁLV. REG.	CITROËN	C3	->	2002/2009	S/ABS
C-3525	CILINDRO DE RODA DIR. 19,05mm C/ VÁLV. REG.	CITROËN	C3	->	2002/2009	S/ABS
C-3526	CILINDRO DE RODA 22,00mm	RENAULT	KANGOO	->	2000/...	
C-3527	CILINDRO DE RODA 15,87mm	VOLKSWAGEN	GOL (G5)	->	2009/...	1.0 E 1.6S/ABS
C-3527	CILINDRO DE RODA 15,87mm	VOLKSWAGEN	VOYAGE (G5)	->	2009/...	1.0 E 1.6S/ABS
C-3528	CILINDRO DE RODA ESQUERDA 23,81mm	HYUNDAI	GALLOPER	->	1998/1999	MOTOR 2.5 TURBODIESEL
C-3528	CILINDRO DE RODA ESQUERDA 23,81mm	MITSUBISHI	L200	->	2003/2012	HPE/SPORT/OUTDOOR
C-3528	CILINDRO DE RODA ESQUERDA 23,81mm	MITSUBISHI	PAJERO	->	1994/1997	MOTOR 2.8 TURBODIESEL
C-3529	CILINDRO DE RODA DIREITA 23,81mm	HYUNDAI	GALLOPER	->	1998/1999	MOTOR 2.5 TURBODIESEL
C-3529	CILINDRO DE RODA DIREITA 23,81mm	MITSUBISHI	L200	->	2003/2012	HPE/SPORT/OUTDOOR
C-3529	CILINDRO DE RODA DIREITA 23,81mm	MITSUBISHI	PAJERO	->	1994/1997	MOTOR 2.8 TURBODIESEL
C-3530	CILINDRO DE RODA 20,63mm	NISSAN	FRONTIER	->	2003/2007	
C-3531	CILINDRO DE RODA 22,22mm	TOYOTA	HILUX PICK-UP	->	2006/...	
C-3531	CILINDRO DE RODA 22,22mm	TOYOTA	HILUX SW4	->	2006/...	

Tabela de Conversão	Polegadas	9/16"	5/8"	11/16"	7/10"	3/4"	13/16"	7/8"	15/16"	1"	1 1/16"	1 1/8"	1 1/4"	1 3/8"	1 1/2"	1 5/8"	1 3/4"	1 27/32"	2"
	Milímetros	14,28mm	15,87mm	17,46mm	17,78mm	19,05mm	20,63mm	22,22mm	23,81mm	25,40mm	26,98mm	28,57mm	31,75mm	34,92mm	38,10mm	41,27mm	44,45mm	46,83mm	50,80mm



PEÇA	DESCRIÇÃO	MARCA	VEÍCULO		ANOS	SOMENTE PARA
C-3532	CILINDRO DE RODA ESQUERDA 22,22mm	GM - CHEVROLET	TRACKER	->	2000/2009	
C-3532	CILINDRO DE RODA ESQUERDA 22,22mm	SUZUKI	GRAND VITARA	->	1998/2003	
C-3533	CILINDRO DE RODA DIREITA 22,22mm	GM - CHEVROLET	TRACKER	->	2000/2009	
C-3533	CILINDRO DE RODA DIREITA 22,22mm	SUZUKI	GRAND VITARA	->	1998/2003	
C-3534	CILINDRO DE RODA 22,22mm	TOYOTA	HILUX PICK-UP	->	1992/2005	4X2
C-3535	CILINDRO DE RODA 20,63mm	CITROËN	C3	->	2006/2012	C/ABS
C-3535	CILINDRO DE RODA 20,63mm	PEUGEOT	106	->	1999/2001	C/ABS
C-3535	CILINDRO DE RODA 20,63mm	PEUGEOT	206 SW	->	2005/2008	SIST. TRW
C-3535	CILINDRO DE RODA 20,63mm	PEUGEOT	207 PASSION	->	2009/...	SIST. TRW
C-3535	CILINDRO DE RODA 20,63mm	PEUGEOT	207 SW	->	2009/...	SIST. TRW
C-3536	CILINDRO DE RODA 22,22mm	NISSAN	FRONTIER	->	2008/...	
C-3537	CILINDRO DE RODA 17,46mm	RENAULT	CLIO	->	2010/2013	
C-3537	CILINDRO DE RODA 17,46mm	RENAULT	LOGAN	->	2008/2013	MOTOR 1.6
C-3537	CILINDRO DE RODA 17,46mm	RENAULT	SANDERO	->	2008/2014	MOTOR 1.6
C-3537	CILINDRO DE RODA 17,46mm	RENAULT	SYMBOL	->	2009/2013	
C-3537	CILINDRO DE RODA 17,46mm	VOLKSWAGEN	UP	->	2014/...	
C-3538	CILINDRO DE RODA 19,05mm	CITROËN	C3	->	2010/2012	S/ABS
C-3539	CILINDRO DE RODA 20,63mm	FORD	FOCUS	->	2010/...	S/ABS
C-3540	CILINDRO DE RODA 15,87mm	KIA	PICANTO	->	2006/2011	
C-3541	CILINDRO DE RODA 20,63mm	GM - CHEVROLET	AVEO	->	2004 / 2011	MOTOR 1.6
C-3541	CILINDRO DE RODA 20,63mm	GM - CHEVROLET	AVEO	->	2006 / 2011	AVEO 5
C-3541	CILINDRO DE RODA 20,63mm	PONTIAC	G3	->	2007 / 2009	MEXICO
C-3541	CILINDRO DE RODA 20,63mm	PONTIAC	G3	->	2009	
C-3541	CILINDRO DE RODA 20,63mm	SUZUKI	SWIFT+	->	2007 / 2011	MEXICO
C-3542	CILINDRO DE RODA 19,00mm	RENAULT	LOGAN	->	2007/2013	EXPRESSION MOTOR 1.0
C-3542	CILINDRO DE RODA 19,00mm	RENAULT	SANDERO	->	2007/2014	EXPRESSION MOTOR 1.0
C-3543	CILINDRO DE RODA 27,00mm	VOLKSWAGEN	AMAROK	->	2011/...	
C-3544	CILINDRO DE RODA 19,00mm	TOYOTA	ETIOS	->	2013/...	
C-3545	CILINDRO DE RODA 17,46mm	HYUNDAI	HB20	->	2012/...	
C-3546	CILINDRO DE RODA 20,63mm	FORD	ECOSPORT	->	2013/...	4X2 / 4X4
C-3547	CILINDRO DE RODA 22,22mm	CITROËN	AIRCROSS	->	2011/...	1.6 16V
C-3547	CILINDRO DE RODA 22,22mm	CITROËN	C3	->	2011/...	PICASSO 1.6 16V

Tabela de Conversão	Polegadas	9/16"	5/8"	11/16"	7/10"	3/4"	13/16"	7/8"	15/16"	1"	1 1/16"	1 1/8"	1 1/4"	1 3/8"	1 1/2"	1 5/8"	1 3/4"	1 27/32"	2"
	Milímetros		14,28mm	15,87mm	17,46mm	17,78mm	19,05mm	20,63mm	22,22mm	23,81mm	25,40mm	26,98mm	28,57mm	31,75mm	34,92mm	38,10mm	41,27mm	44,45mm	46,83mm



---

## SERVO FREIO

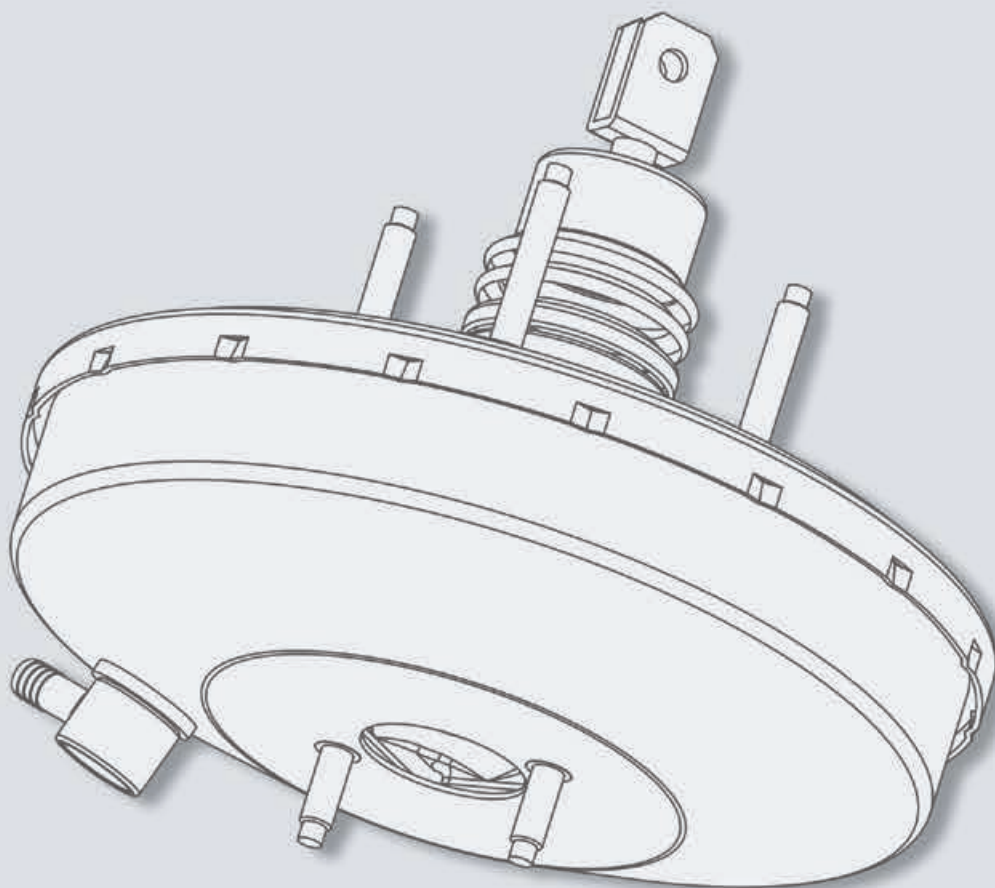

PEÇA	DESCRIÇÃO	MARCA	VEÍCULO		ANOS	SOMENTE PARA
C-5600	SERVO FREIO 200mm	VOLKSWAGEN	GOL (G1)		1981/1996	
C-5600	SERVO FREIO 200mm	VOLKSWAGEN	GOL (G2)		1995/1995	C/ SUPORTE EM FERRO
C-5600	SERVO FREIO 200mm	VOLKSWAGEN	PARATI (G1)		1983/1996	
C-5600	SERVO FREIO 200mm	VOLKSWAGEN	SAVEIRO (G1)		1982/1996	
C-5600	SERVO FREIO 200mm	VOLKSWAGEN	VOYAGE (G1)		1982/1996	
C-5601	SERVO FREIO 200mm	FORD	BELINA II		1980/1991	
C-5601	SERVO FREIO 200mm	FORD	CORCEL II		1980/1986	
C-5601	SERVO FREIO 200mm	FORD	DEL REY		1981/1991	
C-5601	SERVO FREIO 200mm	FORD	PAMPA		1982/1997	
C-5602	SERVO FREIO 200mm	GM - CHEVROLET	CHEVETTE		1977/1986	
C-5602	SERVO FREIO 200mm	GM - CHEVROLET	CHEVY		1983/1986	
C-5602	SERVO FREIO 200mm	GM - CHEVROLET	MARAJÓ		1981/1986	
C-5603	SERVO FREIO 200mm	FORD	ESCORT		1983/1992	SIST. BENDIX
C-5603	SERVO FREIO 200mm	FORD	ESCORT HOBBY		1993/1996	
C-5603	SERVO FREIO 200mm	FORD	VERONA		1990/1992	
C-5603	SERVO FREIO 200mm	VOLKSWAGEN	APOLLO		1990/1992	
C-5604	SERVO FREIO 200mm	VOLKSWAGEN	PASSAT		1977/1989	
C-5607	SERVO FREIO 200mm	GURGEL	G-15		1980/1984	
C-5607	SERVO FREIO 200mm	GURGEL	G-800 CS/CD		1983/1991	
C-5607	SERVO FREIO 200mm	GURGEL	X-15/CARAJÁS		1985/1993	
C-5607	SERVO FREIO 200mm	VOLKSWAGEN	KOMBI		1976/...	
C-5608	SERVO FREIO 230mm	FORD	ROYALE		1992/1996	SIST. VARGA E BOSCH S/ABS
C-5608	SERVO FREIO 230mm	FORD	VERSAILLES		1991/1996	SIST. VARGA E BOSCH S/ABS
C-5608	SERVO FREIO 230mm	TROLLER	T4		1997/2001	
C-5608	SERVO FREIO 230mm	VOLKSWAGEN	QUANTUM		1985/2002	SIST. VARGA E BOSCH S/ABS
C-5608	SERVO FREIO 230mm	VOLKSWAGEN	SANTANA		1984/2006	SIST. VARGA E BOSCH S/ABS
C-5609	SERVO FREIO 230mm	GM - CHEVROLET	MONZA		1981/1987	
C-5610	SERVO FREIO 230mm	GM - CHEVROLET	MONZA		1988/1996	SIST. VARGA E BOSCH S/ABS
C-5612	SERVO FREIO 200mm	GM - CHEVROLET	CARAVAN		1981/1990	SIST. BOSCH
C-5612	SERVO FREIO 200mm	GM - CHEVROLET	OPALA		1981/1990	SIST. BOSCH
C-5613	SERVO FREIO 200mm	FIAT	DUNA		1994/1996	
C-5613	SERVO FREIO 200mm	FIAT	ELBA		1992/1996	SIST. ATE E BOSCH
C-5613	SERVO FREIO 200mm	FIAT	FIORINO (mod. Uno)		1992/1993	SIST. ATE E BOSCH
C-5613	SERVO FREIO 200mm	FIAT	PRÊMIO		1992/1996	SIST. ATE E BOSCH
C-5613	SERVO FREIO 200mm	FIAT	UNO		1992/1999	SIST. ATE E BOSCH
C-5614	SERVO FREIO 200mm	GM - CHEVROLET	IPANEMA		1990/1998	SIST. VARGA E BOSCH
C-5614	SERVO FREIO 200mm	GM - CHEVROLET	KADETT		1989/1998	SIST. VARGA E BOSCH
C-5616	SERVO FREIO 200mm	GM - CHEVROLET	CHEVETTE		1987/1994	SIST. ATE
C-5616	SERVO FREIO 200mm	GM - CHEVROLET	CHEVY		1987/1995	SIST. ATE
C-5616	SERVO FREIO 200mm	GM - CHEVROLET	MARAJÓ		1987/1989	SIST. ATE
C-5617	SERVO FREIO 200mm	FORD	F-100		1979/1987	
C-5617	SERVO FREIO 200mm	FORD	F-1000		1979/1992	
C-5617	SERVO FREIO 200mm	FORD	F-2000		1980/1987	
C-5618	SERVO FREIO 200mm	GM - CHEVROLET	A-10		1979/1984	
C-5618	SERVO FREIO 200mm	GM - CHEVROLET	C-10/14/15/16		1979/1984	
C-5618	SERVO FREIO 200mm	GM - CHEVROLET	D-10		1979/1984	
C-5618	SERVO FREIO 200mm	GM - CHEVROLET	VERANEIO		1979/1988	
C-5619	SERVO FREIO 200mm	GM - CHEVROLET	CHEVETTE		1987/1994	SIST. BOSCH
C-5619	SERVO FREIO 200mm	GM - CHEVROLET	CHEVY		1987/1995	SIST. BOSCH
C-5619	SERVO FREIO 200mm	GM - CHEVROLET	MARAJÓ		1987/1989	SIST. BOSCH
C-5620	SERVO FREIO 200mm	VOLKSWAGEN	GOL (G1)		1996/1996	C/ SUPORTE EM ALUMÍNIO
C-5620	SERVO FREIO 200mm	VOLKSWAGEN	GOL (G2)		1995/2001	MOTOR 1.0/1.6/1.8 S/ABS
C-5620	SERVO FREIO 200mm	VOLKSWAGEN	GOL (G2)		2002/2005	MOTOR 1.0
C-5620	SERVO FREIO 200mm	VOLKSWAGEN	GOL (G3)		2000/2000	MOTOR 1.0/1.6/1.8 S/ABS
C-5620	SERVO FREIO 200mm	VOLKSWAGEN	SAVEIRO (G1)		1997/1997	
C-5621	SERVO FREIO 200mm	AGRALE	1600 A/D RS/RD		1986/1989	
C-5621	SERVO FREIO 200mm	AGRALE	1800 D RS/RD		1988/1989	
C-5621	SERVO FREIO 200mm	GM - CHEVROLET	A-10		1985/1988	
C-5621	SERVO FREIO 200mm	GM - CHEVROLET	A-20		1985/1988	
C-5621	SERVO FREIO 200mm	GM - CHEVROLET	C-10/14/15/16		1985/1988	
C-5621	SERVO FREIO 200mm	GM - CHEVROLET	C-20		1985/1988	
C-5621	SERVO FREIO 200mm	GM - CHEVROLET	D-20		1985/1988	

Tabela de Conversão	Polegadas	9/16"	5/8"	11/16"	7/10"	3/4"	13/16"	7/8"	15/16"	1"	1 1/16"	1 1/8"	1 1/4"	1 3/8"	1 1/2"	1 5/8"	1 3/4"	1 27/32"	2"
	Milímetros	14,28mm	15,87mm	17,46mm	17,78mm	19,05mm	20,63mm	22,22mm	23,81mm	25,40mm	26,98mm	28,57mm	31,75mm	34,92mm	38,10mm	41,27mm	44,45mm	46,83mm	50,80mm

PEÇA	DESCRIÇÃO	MARCA	VEÍCULO		ANOS	SOMENTE PARA
C-5622	SERVO FREIO 200mm	GM - CHEVROLET	CORSA		1994/1995	SIST. DELCO, USE C/ CIL. C-2108
C-5622	SERVO FREIO 200mm	GM - CHEVROLET	CORSA		1994/1998	MOTOR 8V SIST. TEVES
C-5622	SERVO FREIO 200mm	GM - CHEVROLET	CORSA PICK-UP		1995/1998	SIST. ATE
C-5623	SERVO FREIO 230mm	FORD	ESCORT		1993/1996	SIST. VARGA
C-5623	SERVO FREIO 230mm	FORD	VERONA		1994/1996	SIST. VARGA
C-5623	SERVO FREIO 230mm	VOLKSWAGEN	LOGUS		1993/1996	SIST. VARGA
C-5623	SERVO FREIO 230mm	VOLKSWAGEN	POINTER		1994/1996	SIST. VARGA
C-5624	SERVO FREIO 230mm	FORD	ESCORT		1993/1996	SIST. BOSCH
C-5624	SERVO FREIO 230mm	FORD	VERONA		1994/1996	SIST. BOSCH
C-5624	SERVO FREIO 230mm	VOLKSWAGEN	LOGUS		1993/1996	SIST. BOSCH
C-5624	SERVO FREIO 230mm	VOLKSWAGEN	POINTER		1994/1996	SIST. BOSCH
C-5625	SERVO FREIO 200mm	FIAT	TEMPRA		1992/1999	MOTOR 2.0 8V/16V S/ABS
C-5626	SERVO FREIO 200mm	FIAT	BRAVA		2000/2002	MOTOR 1.6 16V
C-5626	SERVO FREIO 200mm	FIAT	COUPÉ		1995/1997	
C-5626	SERVO FREIO 200mm	FIAT	TEMPRA SW		1994/1997	
C-5626	SERVO FREIO 200mm	FIAT	TIPO		1993/1997	
C-5628	SERVO FREIO 230mm	TOYOTA	BANDEIRANTE		1987/1993	
C-5629	SERVO FREIO 200mm	FIAT	FIORINO (mod. Uno)		1994/...	SIST. ATE E BOSCH
C-5629	SERVO FREIO 200mm	FIAT	UNO TURBO		1994/1996	
C-5630	SERVO FREIO 200mm	FIAT	147/SPAZIO		1983/1987	SIST. VARGA
C-5630	SERVO FREIO 200mm	FIAT	FIORINO (mod. 147)		1983/1988	SIST. VARGA
C-5630	SERVO FREIO 200mm	FIAT	OGGI		1983/1985	SIST. VARGA
C-5630	SERVO FREIO 200mm	FIAT	PANORAMA		1983/1987	SIST. VARGA
C-5631	SERVO FREIO 200mm	FIAT	PALIO		1996/1997	S/ABS
C-5631	SERVO FREIO 200mm	FIAT	PALIO WEEKEND		1997/1997	S/ABS
C-5632	SERVO FREIO 230mm	GM - CHEVROLET	ASTRA		1995/1996	SIST. ATE
C-5632	SERVO FREIO 230mm	GM - CHEVROLET	CALIBRA		1993/1995	SIST. ATE
C-5632	SERVO FREIO 230mm	GM - CHEVROLET	VECTRA		1994/1996	SIST. ATE
C-5633	SERVO FREIO 200mm	TOYOTA	BANDEIRANTE		1983/1986	
C-5634	SERVO FREIO 200mm	GM - CHEVROLET	CARAVAN		1979/1980	USE C/ CILINDRO C-2010
C-5634	SERVO FREIO 200mm	GM - CHEVROLET	CARAVAN		1981/1990	SIST. VARGA
C-5634	SERVO FREIO 200mm	GM - CHEVROLET	OPALA		1979/1980	USE C/ CILINDRO C-2010
C-5634	SERVO FREIO 200mm	GM - CHEVROLET	OPALA		1981/1990	SIST. VARGA
C-5635	SERVO FREIO 230mm	FORD	COURIER		1998/...	
C-5635	SERVO FREIO 230mm	FORD	FIESTA		1996/2002	
C-5635	SERVO FREIO 230mm	FORD	FIESTA STREET HATCH		2001/2007	
C-5635	SERVO FREIO 230mm	FORD	FIESTA STREET SEDAN		2002/2004	
C-5635	SERVO FREIO 230mm	FORD	KA		2008/...	
C-5636	SERVO FREIO 230mm	FIAT	PALIO		1998/1999	SIST. ATE E BOSCH S/ABS
C-5636	SERVO FREIO 230mm	FIAT	PALIO WEEKEND		1998/1999	SIST. ATE E BOSCH S/ABS
C-5636	SERVO FREIO 230mm	FIAT	SIENA		1998/1999	SIST. ATE E BOSCH S/ABS
C-5636	SERVO FREIO 230mm	FIAT	STRADA		1999/1999	SIST. ATE E BOSCH S/ABS
C-5637	SERVO FREIO 230mm	VOLKSWAGEN	GOLF		1994/1998	S/ABS
C-5638	SERVO FREIO 200mm	FORD	KA		1997/2007	MOTOR 1.0/1.3
C-5639	SERVO FREIO 230mm	GM - CHEVROLET	VECTRA		1997/2001	MOTOR 2.0/2.2 8V
C-5640	SERVO FREIO 230mm	FORD	ESCORT		1997/2003	
C-5640	SERVO FREIO 230mm	FORD	ESCORT SW		1997/2003	
C-5641	SERVO FREIO 200mm	GM - CHEVROLET	CORSA		1998/2002	MOTOR 8V SIST. ATE
C-5641	SERVO FREIO 200mm	GM - CHEVROLET	CORSA CLASSIC		2003/2009	
C-5641	SERVO FREIO 200mm	GM - CHEVROLET	CORSA PICK-UP		1998/2003	SIST. ATE
C-5642	SERVO FREIO 230mm	GM - CHEVROLET	ASTRA		1995/1996	SIST. DELCO
C-5642	SERVO FREIO 230mm	GM - CHEVROLET	CALIBRA		1993/1995	SIST. DELCO
C-5642	SERVO FREIO 230mm	GM - CHEVROLET	VECTRA		1994/1996	SIST. DELCO CONVEXO
C-5643	SERVO FREIO 230mm	SEAT	CORDOBA		1995/2002	
C-5643	SERVO FREIO 230mm	SEAT	CORDOBA VARIO		2000/2002	
C-5643	SERVO FREIO 230mm	SEAT	IBIZA		1995/2002	
C-5643	SERVO FREIO 230mm	SEAT	INCA		1999/2002	
C-5643	SERVO FREIO 230mm	VOLKSWAGEN	POLO CLASSIC		1997/2002	
C-5643	SERVO FREIO 230mm	VOLKSWAGEN	VAN		1999/2002	
C-5644	SERVO FREIO 200mm	FORD	FIESTA		1995/1995	
C-5645	SERVO FREIO 230mm	GM - CHEVROLET	CARAVAN		1991/1992	
C-5645	SERVO FREIO 230mm	GM - CHEVROLET	OPALA		1991/1992	

Tabela de Conversão	Polegadas	9/16"	5/8"	11/16"	7/10"	3/4"	13/16"	7/8"	15/16"	1"	1 1/16"	1 1/8"	1 1/4"	1 3/8"	1 1/2"	1 5/8"	1 3/4"	1 27/32"	2"
	Milímetros	14,28mm	15,87mm	17,46mm	17,78mm	19,05mm	20,63mm	22,22mm	23,81mm	25,40mm	26,98mm	28,57mm	31,75mm	34,92mm	38,10mm	41,27mm	44,45mm	46,83mm	50,80mm

PEÇA	DESCRIÇÃO	MARCA	VEÍCULO		ANOS	SOMENTE PARA
C-5646	SERVO FREIO 200mm	GM - CHEVROLET	CORSA		1998/2002	MOTOR 16V SIST. ATE
C-5647	SERVO FREIO 200mm	GM - CHEVROLET	CORSA		1997/1998	MOTOR 16V SIST. ATE
C-5648	SERVO FREIO 200mm	FIAT	TEMPRA		1993/1999	MOTOR 2.0 16V C/ABS
C-5649	SERVO FREIO 200mm	FIAT	UNO		2000/2010	
C-5649	SERVO FREIO 200mm	FIAT	UNO		2011/...	MILLE/FURGÃO
C-5650	SERVO FREIO 200mm	VOLKSWAGEN	GOL (G2)		1995/2000	C/ABS
C-5650	SERVO FREIO 200mm	VOLKSWAGEN	GOL (G3)		2000/2001	MOTOR 1.0/1.6/1.8/2.0 C/ABS
C-5650	SERVO FREIO 200mm	VOLKSWAGEN	PARATI (G2, G3 e G4)		1996/2001	MOTOR 1.0/1.6/1.8/2.0 C/ABS
C-5650	SERVO FREIO 200mm	VOLKSWAGEN	SAVEIRO (G2, G3 e G4)		1999/2001	C/ABS
C-5651	SERVO FREIO 200mm	FIAT	PALIO		1996/1997	C/ABS
C-5651	SERVO FREIO 200mm	FIAT	PALIO WEEKEND		1997/1997	C/ABS
C-5652	SERVO FREIO 230mm	FORD	ROYALE		1992/1996	C/ABS
C-5652	SERVO FREIO 230mm	FORD	VERSAILLES		1992/1996	C/ABS
C-5652	SERVO FREIO 230mm	VOLKSWAGEN	QUANTUM		1992/2002	C/ABS
C-5652	SERVO FREIO 230mm	VOLKSWAGEN	SANTANA		1992/2006	C/ABS
C-5653	SERVO FREIO 230mm	FIAT	PALIO		1998/1999	C/ABS
C-5653	SERVO FREIO 230mm	FIAT	PALIO WEEKEND		1998/1999	C/ABS
C-5653	SERVO FREIO 230mm	FIAT	SIENA		1998/1999	C/ABS
C-5653	SERVO FREIO 230mm	FIAT	STRADA		1999/1999	C/ABS
C-5654	SERVO FREIO 200mm	RENAULT	19		1992/1998	SIST. VARGA E TEVES
C-5655	SERVO FREIO 200mm	RENAULT	CLIO		1996/1999	SIST. VARGA, BENDIX E ATE
C-5656	SERVO FREIO 230mm	FIAT	PALIO		2000/...	SIST. ATE E BOSCH S/ABS
C-5656	SERVO FREIO 230mm	FIAT	PALIO WEEKEND		2000/...	SIST. ATE E BOSCH S/ABS
C-5656	SERVO FREIO 230mm	FIAT	SIENA		2000/...	SIST. ATE E BOSCH S/ABS
C-5656	SERVO FREIO 230mm	FIAT	STRADA		2000/...	SIST. ATE E BOSCH S/ABS
C-5657	SERVO FREIO 230mm	FIAT	IDEA		2006/...	MOTOR 1.4
C-5657	SERVO FREIO 230mm	FIAT	PALIO		2000/...	C/ABS
C-5657	SERVO FREIO 230mm	FIAT	PALIO WEEKEND		2000/...	C/ABS
C-5657	SERVO FREIO 230mm	FIAT	SIENA		2000/...	C/ABS
C-5657	SERVO FREIO 230mm	FIAT	STRADA		2000/...	C/ABS
C-5658	SERVO FREIO 200mm	VOLKSWAGEN	GOL (G2)		1995/2000	MOTOR 2.0 S/ABS
C-5658	SERVO FREIO 200mm	VOLKSWAGEN	GOL (G3)		2000/2000	MOTOR 2.0 S/ABS
C-5658	SERVO FREIO 200mm	VOLKSWAGEN	GOL (G3)		2001/2001	MOTOR 1.0/1.6/1.8/2.0 S/ABS
C-5658	SERVO FREIO 200mm	VOLKSWAGEN	GOL (G3)		2002/2005	C/ HASTE TIPO "U"
C-5658	SERVO FREIO 200mm	VOLKSWAGEN	PARATI (G2, G3 e G4)		1996/2001	MOTOR 1.0/1.6/1.8/2.0 S/ABS
C-5658	SERVO FREIO 200mm	VOLKSWAGEN	SAVEIRO (G2, G3 e G4)		1998/2001	S/ABS
C-5659	SERVO FREIO 200mm	GM - CHEVROLET	CELTA		2001/2007	
C-5660	SERVO FREIO 230mm	GM - CHEVROLET	ASTRA		1999/2001	MOD. GL S/ABS
C-5660	SERVO FREIO 230mm	GM - CHEVROLET	ASTRA		2002/2011	S/ABS
C-5661	SERVO FREIO 200mm	VOLKSWAGEN	GOL (G2)		2002/2005	MOTOR 1.6
C-5661	SERVO FREIO 200mm	VOLKSWAGEN	GOL (G3)		2002/2005	MOTOR 1.0/1.6/1.8/2.0 S/ABS
C-5661	SERVO FREIO 200mm	VOLKSWAGEN	GOL (G4)		2006/...	
C-5661	SERVO FREIO 200mm	VOLKSWAGEN	PARATI (G2, G3 e G4)		2002/2012	MOTOR 1.0/1.6/1.8/2.0 S/ABS
C-5661	SERVO FREIO 200mm	VOLKSWAGEN	SAVEIRO (G2, G3 e G4)		2002/2009	S/ABS
C-5662	SERVO FREIO 230mm	RENAULT	CLIO		2000/...	S/ABS
C-5662	SERVO FREIO 230mm	RENAULT	SYMBOL		2009/...	S/ABS
C-5663	SERVO FREIO 230mm	MITSUBISHI	L200		1992/2006	L/GL/GLS
C-5664	SERVO FREIO 230mm	PEUGEOT	206		1999/2001	MOTOR 1.6 8V S/ABS
C-5664	SERVO FREIO 230mm	PEUGEOT	206		2001/2004	MOTOR 1.0 16V
C-5664	SERVO FREIO 230mm	PEUGEOT	206		2005/2010	MOTOR 1.4 8V
C-5664	SERVO FREIO 230mm	PEUGEOT	206 SW		2005/2008	MOTOR 1.4 8V
C-5664	SERVO FREIO 230mm	PEUGEOT	207		2009/...	MOTOR 1.4 8V
C-5664	SERVO FREIO 230mm	PEUGEOT	207 PASSION		2009/...	MOTOR 1.4 8V
C-5664	SERVO FREIO 230mm	PEUGEOT	207 SW		2009/...	MOTOR 1.4 8V
C-5665	SERVO FREIO 230mm	VOLKSWAGEN	GOL (G3)		2000/2001	MOTOR 1.0 TURBO
C-5665	SERVO FREIO 230mm	VOLKSWAGEN	PARATI (G2, G3 e G4)		2000/2001	MOTOR 1.0 TURBO
C-5666	SERVO FREIO 230mm	GM - CHEVROLET	CORSA		2002/2012	
C-5666	SERVO FREIO 230mm	GM - CHEVROLET	MONTANA		2004/2010	
C-5667	SERVO FREIO 230mm	FORD	ECOSPORT		2003/2012	S/ABS
C-5667	SERVO FREIO 230mm	FORD	FIESTA		2003/...	S/ABS
C-5667	SERVO FREIO 230mm	FORD	FIESTA SEDAN		2005/...	S/ABS
C-5668	SERVO FREIO 200mm	GM - CHEVROLET	CELTA		2007/...	

Tabela de Conversão	Polegadas	9/16"	5/8"	11/16"	7/10"	3/4"	13/16"	7/8"	15/16"	1"	1 1/16"	1 1/8"	1 1/4"	1 3/8"	1 1/2"	1 5/8"	1 3/4"	1 27/32"	2"
		Milímetros	14,28mm	15,87mm	17,46mm	17,78mm	19,05mm	20,63mm	22,22mm	23,81mm	25,40mm	26,98mm	28,57mm	31,75mm	34,92mm	38,10mm	41,27mm	44,45mm	46,83mm

PEÇA	DESCRIÇÃO	MARCA	VEÍCULO		ANOS	SOMENTE PARA
C-5668	SERVO FREIO 200mm	GM - CHEVROLET	PRISMA		2007/2012	
C-5669	SERVO FREIO 230mm	VOLKSWAGEN	GOL (G5)		2009/...	SIST. ATE S/ABS
C-5669	SERVO FREIO 230mm	VOLKSWAGEN	SAVEIRO (G5)		2010/...	SIST. ATE S/ABS
C-5669	SERVO FREIO 230mm	VOLKSWAGEN	VOYAGE (G5)		2009/...	SIST. ATE S/ABS
C-5670	SERVO FREIO 230mm	PEUGEOT	206		2001/2008	MOTOR 1.6 16V
C-5670	SERVO FREIO 230mm	PEUGEOT	206 SW		2005/2008	MOTOR 1.6 16V
C-5670	SERVO FREIO 230mm	PEUGEOT	207		2009/...	MOTOR 1.6 16V
C-5670	SERVO FREIO 230mm	PEUGEOT	207 PASSION		2009/...	MOTOR 1.6 16V
C-5670	SERVO FREIO 230mm	PEUGEOT	207 SW		2009/...	MOTOR 1.6 16V
C-5671	SERVO FREIO 200mm	FORD	KA		2001/2007	MOTOR 1.6
C-5672	SERVO FREIO 200mm	GM - CHEVROLET	CORSA CLASSIC		2009/...	1.0S/ABS
C-5673	SERVO FREIO 230mm	RENAULT	LOGAN		2007/2011	S/ABS
C-5673	SERVO FREIO 230mm	RENAULT	SANDERO		2008/2011	S/ABS
C-5674	SERVO FREIO 200mm	FIAT	UNO VIVACE		2011/...	MOTOR 1.0 S/ABS



**Reparo do Cilindro Mestre****Cilindro Mestre****Reparo do Cilindro de Roda****Reparo de Vedação da Pinça****Servo Freio****Cilindro Mestre de Embreagem****Cilindro Atuador Concêntrico de Embreagem****Cilindro de Roda****Manguera do Filtro de Ar****Líquidos para Freio****Fluidos para Radiador****Linha de Filtros**





**Controil**<sup>®</sup>

**FREIOS CONTROL LTDA.**

Capitão Armínio Bier, 205, Vicentina  
95025-360, São Leopoldo - RS, Brasil  
Tel.: (+55) 51 2111 9400  
controil.vendas@controil.com.br  
export@fras-le.com

[www.control.com.br](http://www.control.com.br)